

General catalogue

No. 18 **2024**



Alphabetical index

A-B Plus	225	Hand dusters	124
Alpha Hotel service trolleys line	271	Hand towel dispensers	314
Alpha multipurpose plastic trolleys line	183	Handles	138
APP	301	Handles with tank	91
Atlax	233	KeepHotel	288
Bags	305	Mop holders and mops with pockets and flaps	75
Bags for mop washing	59	Mop holders and pocket mops	71
Bins for large areas	243	Mop holders for dust mops	40
Bins for separate waste collection	234	Mop holders/hooks for trolleys	302
Bonnet mops	61	Mop soaking systems	97
Boost	167	Mops	58
Brilliant	118	Morgan Hotel Elegance service trolleys line	262
Brooms	49	Morgan multipurpose plastic trolleys line	210
Bucket/wringer combos	148	Multipurpose chromed trolleys	217
Buckets	179	Pad holders	54
Carry baskets	295	Paper holders	297
Chromed wet mopping trolleys	165	Plastic mop trolleys	156
Clarus-W	108	Sanitary bins	250
Click	70	Shine	108
Click Safe	100	Silver service trolleys line	292
Cloth holder with rubber blades and with foam sole	42	Spectra-W	115
Cloths/mops for surfaces	129	Speedy	66
Cobweb brushes	121	Telescopic poles	115
Cotton gauzes and cloths	44	Toilet paper dispensers	316
Detergent/Disinfectant dispensers	314	Tools and mops with strap tape system	77
Duo Face	88	Top Clean	135
Dustpans	46	Trolleys for laundry collection	289
Easy Wash	153	Uni-Connect	106
Emotion hotel trolleys line	278	Warning safety signs	145
Flat mops	67	Waste chromed trolleys	255
Floor scrapers	54	Waste plastic trolleys	252
Floor squeegees	55	Wax applicator tools	51
Fuginator	50	Wheels	307
Glass scrapers	121	Window cleaning set	122
Globo	84	Window squeegees	111
Gloss-W	111	Window washers	108
Hairdryers	318	Wringers	167
Hand dryers	317		

Legend



Plastic Second Life certification



EU Ecolabel certification textile products



EU Ecolabel certification wheeled cabinets



CAM compliance in civil and healthcare environments



Eco-friendly textile product



Compatibility with Uni-Connect system



Absence of metal parts



Shock absorbing cover closing



HACCP compliance



Suitability for food contact



General catalogue No. 18 - 2024



FILMOP INTERNATIONAL PRIMARY GOAL IS TO DESIGN AND CREATE THE BEST CLEANING SYSTEMS IN THE FULL RESPECT FOR THE ENVIRONMENT

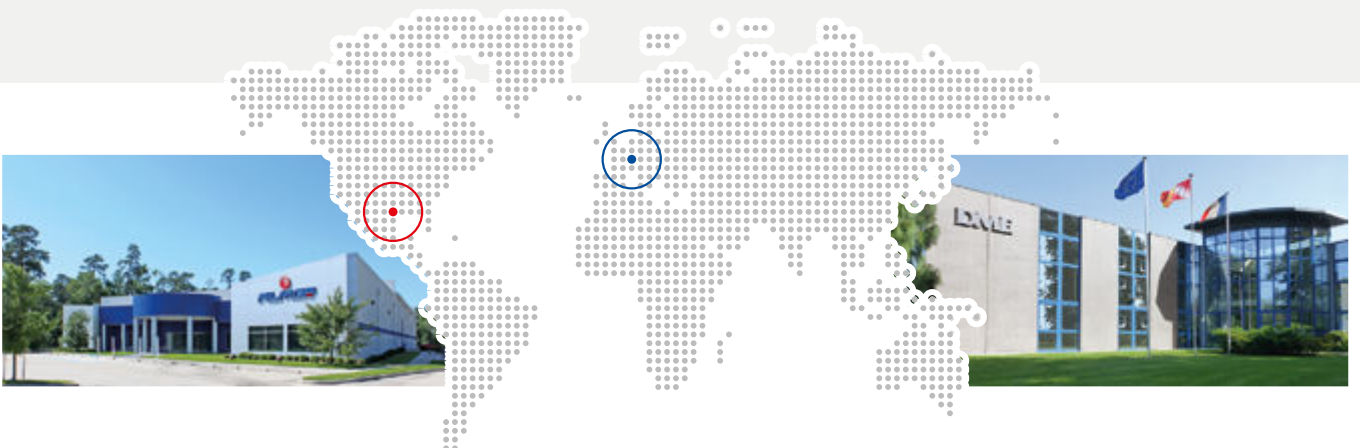

A world leader Italian company in the professional cleaning market

Filmop International was founded in the early 70s as a company specialized in the **design and production of manual cleaning equipment** for professional use.

The **40,000-square-meter plant** located in northeastern Italy was joined by a **French distribution branch** in 1997 and an **American branch** in 2004, strengthening the company's presence in their respective markets.

Proud to spread "**Made in Italy**" around the world, today Filmop International **exports to more than 80 countries** with the utmost speed, reliability and efficiency.

Mission

Filmop International has always been inspired by the following main principles, that are surely behind its growth and development:

- a strong push for **innovation** and **research**
- a constant **attention towards customer's satisfaction**
- unequalled **production flexibility**
- a considerable **quick order processing**

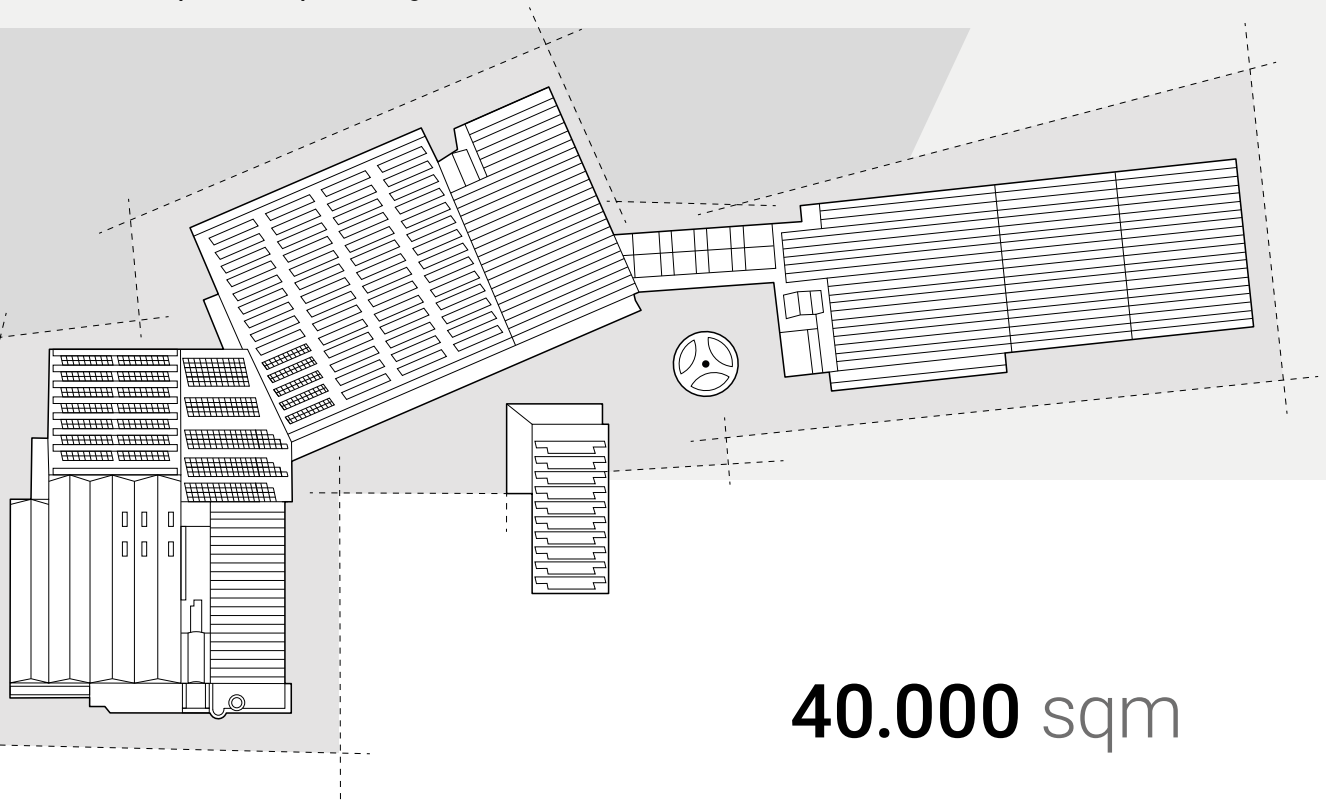

40.000 sqm



50 YEARS OF SUCCESS IN THE
PROFESSIONAL CLEANING SECTOR



An Italian reality acknowledged worldwide

Filmop International's is a **story of quality that began in 1974** and has resulted in **over 4000 items** and has been awarded with prestigious **company and product certifications**. The achievements of half a century of commitment and a product range full of successes have made the company an authoritative leader, a trusted partner and the undisputed protagonist of an ever-evolving cleaning industry.

Today Filmop International is a widely recognised institution on the international cleaning scene and a point of reference for cleaning professionals. The company proudly **spreads the excellence of Made in Italy** by exporting to **over 80 countries** worldwide, in many of which it is the main supplier.





FILMOP INTERNATIONAL IS A TRUSTED PARTNER TOTALLY ORIENTED
TOWARDS CUSTOMER'S SATISFACTION



Your trusted partner

Those choosing Filmop International know they can rely on a **qualified partner**, organized to ensure **prompt order processing with fast and on-time deliveries**.

The company also stands out for its great **production flexibility**: each new customer request receives an immediate and careful analysis by the technical office to identify and develop the best possible solution.

Pre- and after-sales service helps customers to choose the most suitable cleaning system for their specific needs, supporting them with on-site inspections and training courses on site or in the exclusive setting of **Filmop Academy**.

Finally, Filmop International provides a range of **marketing tools** aimed at increasing the depth of the range of products and systems offered:

- **web site** with detailed and constantly updated information
- freely accessible **catalogs and product sheets**
- **FilmopTalk online magazine** with industry articles and interviews
- **You Tube channel** with videos and tutorials
- **Alpha Configurator app** to design customized trolleys
- **Filmop Academy** for product and procedure training
- **showroom** for the wide range on offer





FILMOP INTERNATIONAL HAS DEVELOPED SKILLS TO ACHIEVE HIGH BUSINESS AND PRODUCT STANDARDS



Certification ISO 9001



Certification ISO 14001

Fulfillment of obligations under the European REACH regulation

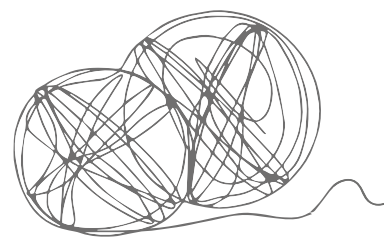

The certifications of Filmop International

The quality of the products and services offered by the company is guaranteed by the following certifications:

- **2000 | Quality Certification UNI EN ISO 9001:2015:** Filmop bases its growth on an organized business system with efficient management, suitable facilities and adequate skills
- **2011 | Environmental certification UNI EN ISO 14001:2015:** Filmop has chosen to implement an environmental management system to control the impacts of its activities on the ecosystem
- **2012 | Second Life Plastics:** Filmop offers a wide range of trolleys, bins and buckets with components made using recycled plastics
- **2015 | EU Ecolabel:** Filmop has obtained for many cloths, mops, flat mops and kentucky mops the eco-label that rewards the best environmentally sustainable products by qualifying them on the market
- **2022 | Carbon Footprint Systematic Approach:** Filmop has obtained the certification of the system for calculating the climate footprint of the trolleys, carried out in accordance with UNI EN ISO 14067:2018
- **2023 | EU Ecolabel:** Filmop has obtained for some Alpha wheeled cabinets the Type I environmental label identifying the best products from a sustainability point of view

The company fulfills its obligations under European Regulation **REACH**: it purchases raw materials from trusted and qualified suppliers, who declare that they comply with current supply chain regulations.

Finally, it meets the criteria of **BRC**, a structured management system for hygiene control and product safety.





AT THE FOREFRONT OF ENVIRONMENT OFFERING
PRODUCTS AND CLEANING SYSTEMS IN COMPLIANCE
WITH CAM CRITERIA

CAM criteria

The Minimum Environmental Criteria (CAM) for the contracting of **cleaning** services in **civil environments** and **cleaning and sanitising of healthcare environments** include a number of technical specifications, contractual clauses and awarding criteria that aim to **minimise the environmental impacts** associated with the relevant activities and supplies.



Filmop International has over time produced **countless products and systems in line with the requirements set out in both CAMs:**

TECHNICAL SPECIFICATIONS

- Dosing systems that avoid operator discretion: **Equodose dosing device to control the degree of textile soaking**

CONTRACTUAL CLAUSES

- Reusable flat microfibres for chemical reduction: **wide range of microfibres with dTex \leq 1**
- Label according to EN ISO 14024 for at least 30% of the microfibres: **EU Ecolabel-certified microfibre head mops and mops**
- Recycled textiles for dusting operations: **range of recycled cotton dusting mops**
- Soaking systems reducing water and chemical consumption: **Equodose dosing device for soaking textiles directly on the trolley**
- Trolleys with wringer with two buckets or bucket with double basin: **washing and multi-purpose trolleys that separate clean and rinse water**
- Trolleys with buckets in different colours depending on use, made of 50% recycled plastic by weight: **wide range of trolleys complete with buckets in different colours, made of suitable percentages of recycled plastic**
- Solutions for waste management: **AlphaSplit trolleys to collect different types of waste in special sections and a complete range of colour-coded waste collection bins**

AWARDING CRITERIA

- Exclusive use of microfibres with UNI EN ISO 14024 compliant labelling: **wide assortment of EU Ecolabel-certified microfibres**



A successful range of products

For Filmop International, being successful means being able to **understand, read and be ahead of market needs**. This aptitude has led it to take a **leading role** in the process of change that has affected the professional cleaning industry over the past three decades.

In particular, Filmop International was the first Italian manufacturing company with a special attention to:

- in the importance of **alternative materials to metal** such as polypropylene, which is strong, lightweight and totally recyclable
- in the need for **separation of clean water from rinse water** as a basic prerequisite for professional cleaning
- in the value of **ergonomic cleaning systems** that can improve operators' working conditions

These three concepts are the main pillars of a successful business and production policy, that has led to a complete range of products for professional cleaning with **more than 4.000 finished items**.



SOME OF THE
PATENTED SYSTEMS
 THAT REVOLUTIONISED
 CLEANING

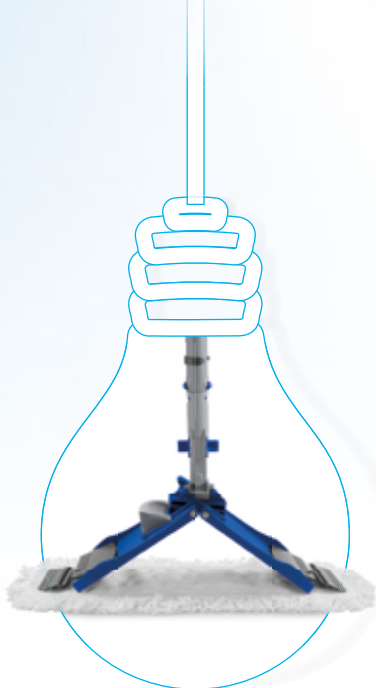
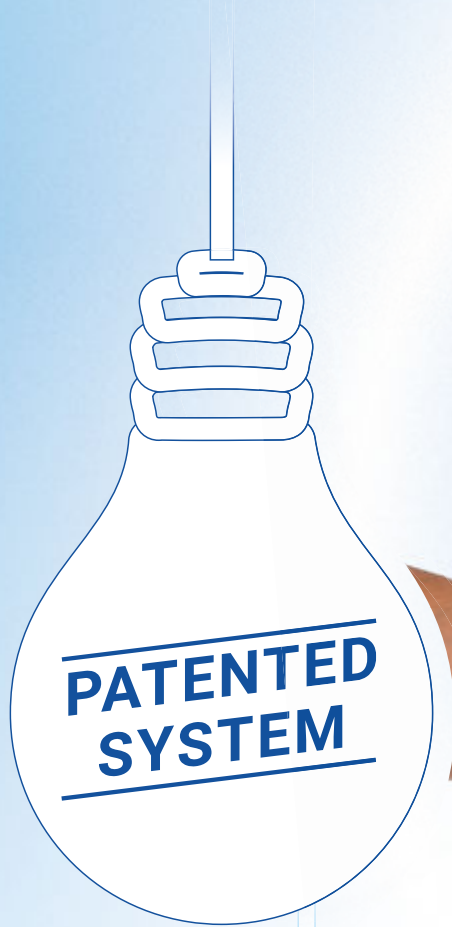

Globo System

**THE FIRST AND ONLY UNIVERSAL
 CLEANING SYSTEM**

Universal system that can be used
 like any traditional system, ensuring
higher performance



Click Safe

**ENSURED HYGIENE WITH
 CONTACTLESS RELEASE**

Touchless system that allows
 detaching the mop while avoiding
 any contact with bacteria and
 viruses

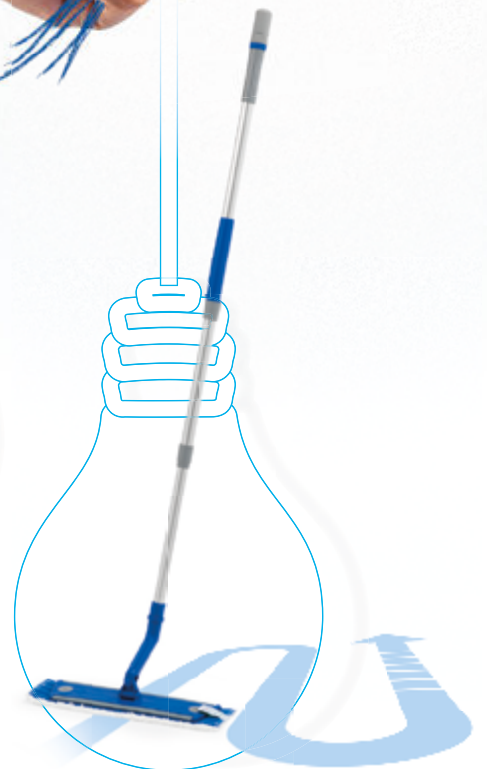

ErgoSwing

**MAXIMUM RESULTS WITH
 MINIMUM EFFORT**

Ergonomic system designed to
 follow the **S-shaped movement**
 while minimising strain

INNOVATION LEADS THE WAY

50 years of success. Over 4000 products.
More than 100 patents.

A strong drive for innovation and relentless research and development work have paved the way, resulting in a succession of inventions that make Filmop products **unique and unrepeatable**.

Technological innovations developed over time have made history in professional cleaning, contributing concretely to make it more **effective and efficient**.

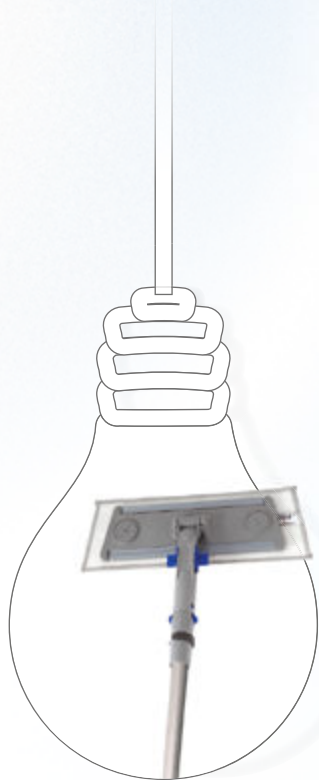

Lock System

**UNEQUALLED VERSATILITY
TO GET ANYWHERE**

System that allows to lock/unlock the joint to **facilitate the cleaning of walls and ceilings**

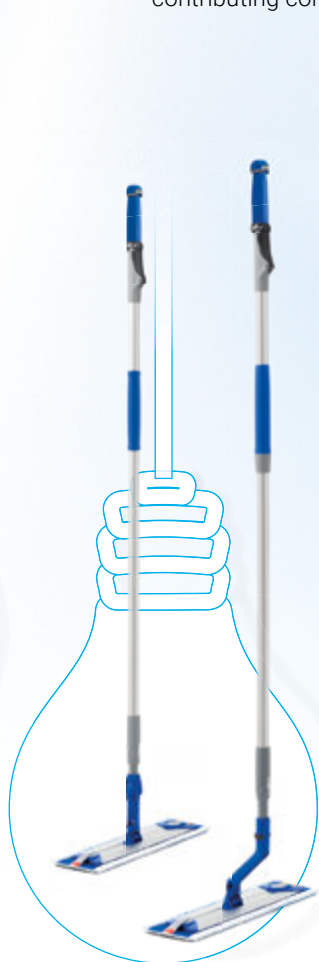

Drop & ErgoDrop

**CONVENIENCE AND SAFETY
AT YOUR FINGERTIPS**

Ready-to-use system allowing **cleaning solution to be dosed according to actual needs**



Uni-Connect

**A COMPLETELY CONNECTED
CLEANING SYSTEM**

Innovative system that **connects glass, surface and floor cleaning equipment instantly and safely**

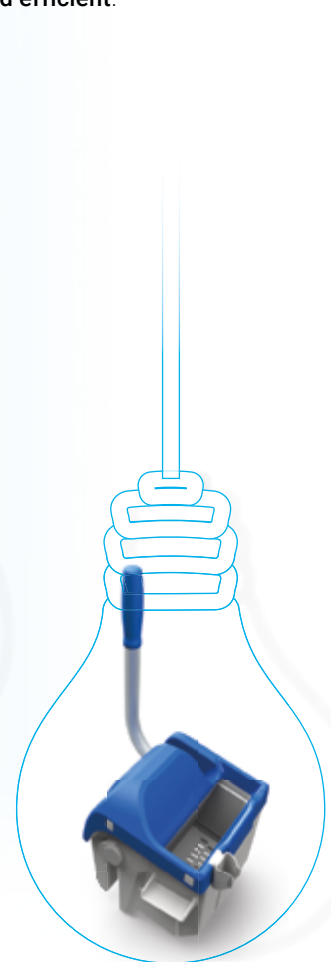

Boost

+20% WRINGING, -52% EFFORT

Wringing system that **wrings 20% more with half the effort** than traditional wringers



FILMOP INTERNATIONAL'S CONTRIBUTION TOWARD SUSTAINABLE DEVELOPMENT IS REALIZED IN ITS COMMITMENT TO ENVIRONMENTAL PROTECTION

Equodose® adjustable dispenser to save cleaning solution



AlphaSplit System to facilitate separate waste collection



Commitment to sustainable development

In an age in which the preservation of our environment is the world top priority, Filmop International is strongly engaged and oriented towards a policy of sustainable development.

Since its origins, the company has followed a **precise path toward eco-sustainability** that has enabled it to achieve important results over time:

- Corporate and product **environmental certifications**
- Selection of qualified suppliers according to the **European REACH Regulation**
- Use of **raw materials of recycled origin**
- Development of **products and systems with low environmental impact**
- Products made from separable materials and thus **recyclable at end of life**
- **Production and use of solar energy** thanks to photovoltaic systems
- Efficient organization of the **separate waste collection and leftovers**
- **Environmental labelling of packaging** to promote proper disposal



Wide range of high performance dTex ≤ 1 microfibers



 Products with Plastic
 Second Life certified
 components



Certification of the Carbon Footprint Systematic Approach

Filmop International has decided to keep on its path toward eco-sustainability by taking a further step forward: extensive analysis, planning and development work has enabled the company to implement a **system for quantifying Product Carbon Footprint** based on a systematic approach.

The work done was recognized by an independent, accredited verification company that **certified the implemented system** after carrying out a detailed evaluation.

Through the Carbon Footprint Systematic Approach, Filmop International can **calculate the climate footprint of the entire range of trolleys**, from buckets and mop trolleys to multi-purpose and service trolleys.

Counting of **CO₂e** is done for **every phase of the product life cycle**: from raw material sourcing to production, through transport and consumer use to end-of-life disposal.

Green Looks good on us

DETECTING THE CLIMATE FOOTPRINT OF PRODUCTS AND TURNING IT INTO OBJECTIVE DATA ENABLES SPECIFIC ACTIONS TO BE IMPLEMENTED TO PROMOTE SUSTAINABLE DEVELOPMENT



CARBON FOOTPRINT SYSTEMATIC APPROACH



INVESTING IN RENEWABLE ENERGY
TO CREATE A BETTER FUTURE

GREEN ENERGY



Production and use of clean energy

Filmop wants to play a concrete role in promoting sustainable development and countering global warming, which is why it chose to **minimise the impact of its business activities** by installing a **photovoltaic system** at its headquarters in 2011.

The production of **solar energy** for self-consumption or feeding into the grid **avoids the release of tonnes of CO2 into the atmosphere each year**.

Carbon offset projects

In addition to its use of sustainable energy for more than a decade, Filmop has chosen to join major **international carbon offset projects** that include the **installation of renewable energy plants in developing countries** to generate clean energy by facilitating access to it for local populations.



Andhra Pradesh
India

 SUSTAINABLE DEVELOPMENT GOALS





CHOOSE PRODUCTS WITH ENVIRONMENTAL CERTIFICATIONS: A RESPONSIBLE CHOICE TO PROTECT THE ENVIRONMENT

EU Ecolabel

Filmop International has obtained for many **cloths, mops, flat mops and Kentucky mops** and for some **Alpha** wheeled cabinets the prestigious **EU Ecolabel** certification, the EU **environmental label** that rewards the best environmentally sustainable products.

The certification attests to the low environmental impact of products after analyzing their sustainability throughout their life cycle through a very selective set of parameters established by the European Community.

The full range of EU Ecolabel-certified products is available in the European ECAT registry:

<http://ec.europa.eu/ecat/products/en/22016/n-a>

The certified product lines

Plastic Second Life

Filmop International is the first Italian company in the cleaning equipment sector to have obtained **Plastic Second Life** certification, the first **European label dedicated to recycled plastics** created to guarantee and easily identify goods made using recycled plastics.

Filmop offers several lines of **trolleys, bins and buckets** with components made with significantly higher percentages of PSV polypropylene than the minimum required, while maintaining original colors and the same quality.



**plastic**
second life
MIX ECO



FILMOP INTERNATIONAL TEXTILES PROTECT
THE ENVIRONMENT AND OUR HEALTH

Release of microplastics: test passed with flying colours

The presence of **microplastic particles** in aquatic ecosystems has attracted general attention in recent years, becoming the subject of an increasing number of studies motivated by environmental and health concerns.

Eco Multi-T manual cloth and **Micro-Activa, Twist-Tuft, Rapido Super Extra, Rapido Super, Rapido, Duo Face Wash Basic, Puli-Brush** and **Puli-Scrub** mops were tested by a highly specialised independent laboratory for the release of microplastics.

All products passed with flying colours the test: the analysis showed particularly low losses in washing and rinsing by the Eco Multi-T cloth and the Micro-Activa, Twist-Tuft, Duo Face Wash Basic, Puli-Brush, and Puli-Scrub mops which received the highest rating. In addition, low release was found regarding the Rapido Super Extra, Rapido Super and Rapido mops.

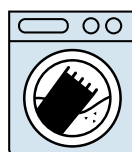

LOW ENVIRONMENTAL
IMPACT PRODUCTS



WITH ALPHA CONFIGURATOR YOU CAN ENJOY DESIGNING
A CUSTOMIZED CLEANING TROLLEY



Pc



iPad

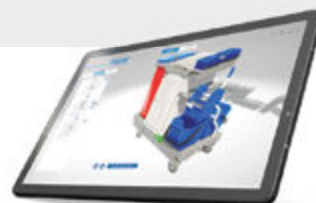

Tablet

Your ideal trolley with a click

Alpha Configurator is Filmop International's application that allows you to **create in a few simple steps a customized trolley**, configured according to your specific needs: you can freely choose the number of units, washing systems, doors, accessories, colors and more, thus creating the ideal trolley for every cleaning need.

The **3D version for PC, tablet and iPad** allows you to **customize the trolleys in every detail**: the many combinations offered and the wide range of products and accessories available, including the latest news, make the configuration possibilities endless.

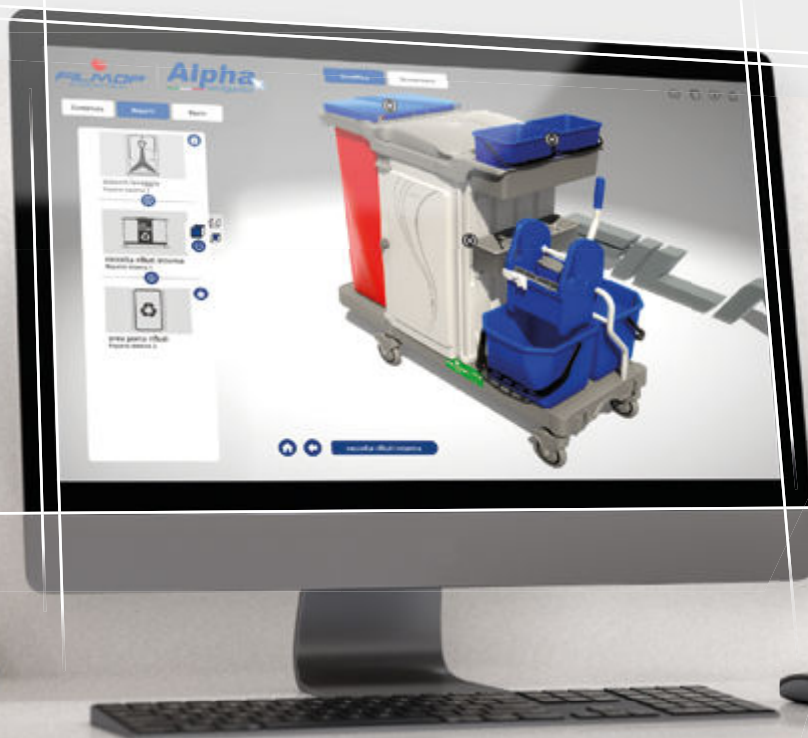



FILMOP INTERNATIONAL GUARANTEES QUALITY PRODUCTS, THE RESULT OF CAREFUL RESEARCH AND SELECTION OF RAW MATERIALS



Washing temperature



Cold water washing



Hand washing



No chlorine-based bleach during



Low temperature drying



No ironing



Do not dry clean



No drying-chamber

Maintenance and care of textile products

To keep performance unchanged over time and help extend the life cycle as much as possible, please pay special attention to the **washing instructions** below:

- Follow carefully the washing instructions and warnings on the detergent packaging (temperature and dosing) before washing
- Always pre-wash microfiber mops in cold water without detergent to remove residues of the chemical solution
- We recommend the use of normal detergent for textiles, no fabric softener
- We suggest to use the specific net bags for the mop washing
- Do not use chlorine or bleach
- Do not use softener
- Use alkaline detergents with Ph <11

For more details **see the product data sheets**, which can be freely downloaded from the website www.filmop.com.



NEW New products index

Industrial push broom with external soft bristles and internal hard bristles with ring



Page 50

Industrial broom hard bristles with ring



Page 50

Industrial broom soft bristles with ring



Page 50

Industrial high broom hard bristles with ring



Page 50

Smart-Fur microfiber jointed sleeve for wax application



Page 52

SMART FUR - microfiber sleeve for wax application



Page 52

CLARUS-W PRIME - complete window washer polyester short yarn with scrubbing fibres, with plastic support with Italian thread



Page 109

CLARUS-W PRIME - complete window washer polyester short yarn with scrubbing fibres and abrasive fibre, with plastic support with Italian thread



Page 109

CLARUS-W MASTER - aluminium support for washer sleeve with Italian thread



Page 109

CLARUS-W MASTER - jointed aluminium support for washer sleeve with Italian thread



Page 109

Window washer sleeve short yarn with scrubbing fibres



Page 110

Window washer sleeve short yarn with scrubbing fibres and abrasive pad



Page 110

GLOSS-W AMBO - plastic window squeegee and sleeve with aluminium holder with Italian thread



Page 110

Plastic grip with window washer support for Gloss-W Ambo with Italian thread



Page 110

GLOSS-W PRIME - complete plastic squeegee with Italian thread and blue rubber blade



Page 112

GLOSS-W PRIME - complete plastic window squeegee with Italian thread



Page 112

GLOSS-W PRIME - complete jointed plastic squeegee with Italian thread and blue rubber blade



Page 113

GLOSS-W PRIME - complete plastic jointed window squeegee with Italian thread



Page 113

Plastic grip for Gloss-W Prime window squeegee with Italian thread



Page 113

Plastic grip for Gloss-W Prime jointed window squeegee with Italian thread



Page 113

Blue rubber blade for window squeegee



Page 114

SPECTRA-W PRO - Aluminum pole complete with cone with Italian thread for Uni-Connect system



Page 116

SPECTRA-W PRO - Aluminum telescopic pole complete with end cone with Italian thread for Uni-Connect system - 2 pieces



Page 116

SPECTRA-W PRO - Aluminum telescopic pole complete with end cone with Italian thread for Uni-Connect system - 3 pieces

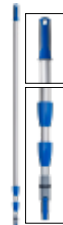

Page 116

Joint for telescopic pole with Italian thread



Page 117

Cone with American thread for Uni-Connect system



Page 117

SHINE - glass line trolley



Page 122

20 Lt plastic bucket with plastic handle complete with sieve and squeegee holder



Page 122

Window squeegees support for 10 and 20 Lt buckets



Page 122

Manual plastic sleeve wringer



Page 122

Kit for window cleaning



Page 122

Adjustable belt with 2 pockets for tools



Page 123

Plastic ring to hold polybags, for belt



Page 123

Multipurpose sponge with abrasive fibres



Page 132

Rilsan coated wall-fixing support for AtlaxFlip and AtlaxFit bins



Page 236

APP - tool-hanging system with support for ø 20/30 mm handles and hooks



Page 301

APP - set 2 hooks for tools with wall fixing



Page 301

APP - support for ø 20/30 mm handles with wall fixing



Page 301

Aluminium bar for App system



Page 301

Tool holder hook for App system



Page 301

Support for ø 20/30 mm handles for App system



Page 301

Replaced items

Old codes

New codes

MA0506702U027	ALPHA 0506702 - plastic trolley with Click Safe system	MA0506702U032	ALPHA 0506702 - plastic trolley with Click Safe system	Page 193
MA0506711U000	ALPHA 0506711 - plastic trolley	MA0506711U006	ALPHA 0506711 - plastic trolley	Page 194
MA2606701U000	ALPHA 2606701 - plastic trolley	MA2606701U050	ALPHA 2606701 - plastic trolley	Page 194
0000MA2672U00	ALPHA 2672 - plastic trolley	0300MA2672U00	ALPHA 2672 - plastic trolley	Page 193
MA3606718U000	ALPHA 3606718 - plastic trolley	MA3606718U006	ALPHA 3606718 - plastic trolley	Page 194
0000MA5671U00	ALPHA 5671 - plastic trolley	0300MA5671U00	ALPHA 5671 - plastic trolley	Page 193
0000MA6670U00	ALPHA 6670 - plastic trolley	0300MA6670U00	ALPHA 6670 - plastic trolley	Page 194
MX3336700U007	ALPHA METAL FREE 3336700 - plastic trolley	MX3336700U009	ALPHA METAL FREE 3336700 - plastic trolley	Page 197
9080A	Aluminium pole, 1,25 m	00059880A	Aluminium pole with cone for Uni-Connect system, 1,25 m	Page 116
0000AS21150A	Aluminium pole, 1,5 m	0005AS28150A	Aluminium pole with cone for Uni-Connect system, 1,5 m	Page 116
9079A	Aluminium telescopic pole 2 pcs x 0,60 m	00059879A	Telescopic aluminium pole with cone for Uni-Connect system, 2 pcs x 0,60 m	Page 116
00059081A	Aluminium telescopic pole 2 pcs x 1,25 m, in a pack of 5 pcs	00059881A	Telescopic aluminium pole with cone for Uni-Connect system, 2 pcs x 1,25 m, in a pack of 5 pcs	Page 116
00059078A	Aluminium telescopic pole 2 pcs x 1,50 m, in a pack of 5 pcs	00059878A	Telescopic aluminium pole with cone for Uni-Connect system, 2 pcs x 1,50 m, in a pack of 5 pcs	Page 116
00059082A	Aluminium telescopic pole 2 pcs x 2,00 m, in a pack of 5 pcs	00059882A	Telescopic aluminium pole with cone for Uni-Connect system, 2 pcs x 2,00 m, in a pack of 5 pcs	Page 116
00059083A	Aluminium telescopic pole 2 pcs x 3,00 m, in a pack of 5 pcs	00059883A	Telescopic aluminium pole with cone for Uni-Connect system, 2 pcs x 3,00 m, in a pack of 5 pcs	Page 116
00059086A	Aluminium telescopic pole 3 pcs x 1,00 m, in a pack of 5 pcs	00059886A	Telescopic aluminium pole with cone for Uni-Connect system, 3 pcs x 1,00 m, in a pack of 5 pcs	Page 116
00059087A	Aluminium telescopic pole 3 pcs x 1,50 m, in a pack of 5 pcs	00059887A	Telescopic aluminium pole with cone for Uni-Connect system, 3 pcs x 1,50 m, in a pack of 5 pcs	Page 116
00059084A	Aluminium telescopic pole 3 pcs x 2,00 m, in a pack of 5 pcs	00059884A	Telescopic aluminium pole with cone for Uni-Connect system, 3 pcs x 2,00 m, in a pack of 5 pcs	Page 116
00059085A	Aluminium telescopic pole 3 pcs x 3,00 m, in a pack of 5 pcs	00059885A	Telescopic aluminium pole with cone for Uni-Connect system, 3 pcs x 3,00 m, in a pack of 5 pcs	Page 116
9090A	Aluminium telescopic pole 3 pcs, 4+4+3 m	00059890A	Telescopic aluminium pole with cone for Uni-Connect system, 3 pcs, 4+4+3 m	Page 116
9216	CLIP - scraper with 10 blades	9316	CLIP - scraper with 10 blades	Page 121
8169A	PATTY - plastic white bin, with blue swing cover, 25 lt	0020CO7025DA	ATLAXFLIP - white plastic bin with blue swing cover, 25 lt	Page 234
8169C	PATTY - plastic white bin, with yellow swing cover, 25 lt	0020CO7025DC	ATLAXFLIP - white plastic bin with yellow swing cover, 25 lt	Page 234
8169B	PATTY - plastic white bin, with red swing cover, 25 lt	0020CO7025DB	ATLAXFLIP - white plastic bin with red swing cover, 25 lt	Page 234
8169F	PATTY - plastic white bin, with swing cover verde, 25 lt	0020CO7025DF	ATLAXFLIP - white plastic bin with green swing cover, 25 lt	Page 234
8169	PATTY - plastic bin with swing cover, white, 25 lt	0000CO7025D	ATLAXFLIP - plastic bin with swing cover, white, 25 lt	Page 234
9161	Aluminium jointed support for window washer, 25 cm	9441	CLARUS-W MASTER - jointed aluminium support for washer sleeve, 25 cm	Page 109
9162	Aluminium jointed support for window washer, 35 cm	9442	CLARUS-W MASTER - jointed aluminium support for washer sleeve, 35 cm	Page 109
9163	Aluminium jointed support for window washer, 45 cm	9443	CLARUS-W MASTER - jointed aluminium support for washer sleeve, 45 cm	Page 109
8169/1	White plastic bin without cover, 25 lt	P190081D	Plastic bin for AtlaxFlip without cover, white	Page 235
60185A	Complete cover for Patty 25 lt, white with blue swing	0020P190082DA	Swing cover for AtlaxFlip 25 lt, white with blue swing	Page 235
60185C	Complete cover for Patty 25 lt, white with yellow swing	0020P190082DC	Swing cover for AtlaxFlip 25 lt, white with yellow swing	Page 235

Old codes

New codes

60185B	Complete cover for Patty 25 lt, white with red swing	0020P190082DB	Swing cover for AtlatxFlip 25 lt, white with red swing	Page 235
60185F	Complete cover for Patty 25 lt, white with green swing	0020P190082DF	Swing cover for AtlatxFlip 25 lt, white with green swing	Page 235
60185	Complete cover for Patty 25 lt, white with white swing	P190082D	Swing cover for AtlatxFlip, white, 25 lt	Page 235
00FM0401K00	GLOBO COTTON cotton mop with polyester backing, looped yarn inside, cut yarn outside, with micro flaps, 40x13 cm	00FM0401K01	GLOBO COTTON cotton mop with polyester backing, looped yarn inside, cut yarn outside, with micro flaps, 40x13 cm	Page 86
9351	Complete window squeegee 25 cm with jointed handle	9751	GLOSS-W PRIME -complete jointed plastic squeegee, 25 cm	Page 113
9352	Complete window squeegee 35 cm with jointed handle	9752	GLOSS-W PRIME -complete jointed plastic squeegee, 35 cm	Page 113
9353	Complete window squeegee 45 cm with jointed handle	9753	GLOSS-W PRIME -complete jointed plastic squeegee, 45 cm	Page 113
9354	Complete window squeegee 55 cm with jointed handle	9754	GLOSS-W PRIME -complete jointed plastic squeegee, 55 cm	Page 113
9461	Jointed grip for window squeegee	9761	Plastic grip for Gloss-W Prime jointed window squeegee	Page 113
0000PN03040	MONO-TEX - microfibre disposable pocket mop (pack: 10 bags of 50 pcs.), 40 cm	0000PN03140	MONO-TEX - microfibre disposable pocket mop (pack: 12 bags of 35 pcs.), 40 cm	Page 75
TA50029	Aluminium vertical frame 29,6 cm for Silver trolley with three shelves	0000SM00225	Set 2 pcs frames for Silver with two shelves	Page 293
TA50066	Aluminium vertical frame 66 cm for Silver trolley with two shelves	0000SM00242	Set 4 pcs frames for Silver with three shelves	Page 293
P225004A	Set of plastic paper holder with cover complete with 3 hooks	P225004U	Set of plastic paper holder with cover complete with 3 hooks	Page 297
9402	Polyester sleeve for wax application, 35 cm	9421	SMART-FUR - grey sleeve for wax application, 35 cm	Page 52
9109	Polyester sleeve for wax application, 40 cm	9423	SMART-FUR - grey sleeve for wax application, 40 cm	Page 52
000E121D	SPEEDY RAPIDO - microfibre flat mop, polyester backing, looped yarn, flaps with 2 holes, 40x13 cm	0000121D	SPEEDY RAPIDO - microfibre flat mop, polyester backing, looped yarn, flaps with 2 holes, 40x13 cm	Page 68
000E611D	SPEEDY RAPIDO - microfibre flat mop, polyester backing, looped yarn, flaps with 2 holes, 50x16 cm	0000611D	SPEEDY RAPIDO - microfibre flat mop, polyester backing, looped yarn, flaps with 2 holes, 50x16 cm	Page 68
8132AB	Plastic foldable disinfection mop holder, 40X11 cm	8132AU	Plastic foldable disinfection mop holder, 40X11 cm	Page 72
8130AB	Plastic foldable disinfection mop holder, 50x13 cm	8130AU	Plastic foldable disinfection mop holder, 50x13 cm	Page 72
9400	Complete washer sleeve for wax application, 35 cm	9430	Smart-Fur complete jointed grey microfibre washer sleeve, 35 cm	Page 52
9100	Complete washer sleeve for wax application, 40 cm	9431	Smart-Fur complete jointed grey microfibre washer sleeve, 40 cm	Page 52

Deleted articles

0000AT0180C	120 L self-supporting plastified bag with eyelets and zipper, yellow
0000CO3035D	SIRIUS - plastic bin 30 lt with pedal and bag stretcher, with grey cover
0000CO3065D	SIRIUS - plastic bin 60 lt with pedal and bag stretcher, with grey cover
0000CO3135D	SIRIUS - plastic bin 2x15 lt with pedal and bag stretcher, with grey cover
0000CO3165D	SIRIUS - plastic bin 2x30 lt with pedal and bag stretcher, with grey cover
0000CO3235D	SIRIUS - plastic bin 15 lt + 2x8 lt with pedal and bag stretcher, with grey cover
0000CO3265D	SIRIUS - plastic bin 30 lt + 2x15 lt with pedal and bag stretcher, with grey cover
0000D253000	Microfiber bonnet mop ø 53 cm - 21"
0000LP0322A2	VEGA TOP-DOWN - plastic trolley
0000SE1214FT	14 lt plastic bucket with plastic handle, green
0000SE1314FT	TOP-DOWN - plastic bucket with plastic handle and hermetic cover, 14 lt, green
00PD04L0L10AA	DUO FACE WASH BASIC/ SAFE - microfiber double-faced mop, wet mopping/wet mopping on non-slip floors, blue, 40 cm
00PD04L0L10AB	DUO FACE WASH BASIC/ SAFE - microfiber double-faced mop, wet mopping/wet mopping on non-slip floors, blue/red, 40 cm
00PV0010	DISPLAY - stand with compartments for disinfectant, disposable gloves and check-list holder
21003	Plastic sieve for buckets 25 L
42100A	Bucket support for Spider Max with pirouetting wheels ø 50 mm
5411	Foldable iron mop holder, iron joint, 100 cm
5411/PA	Foldable iron mop holder, plastic joint, 100 cm
60152A	Blue divider for Spider bucket
60185E	Complete cover for Patty 25 lt, white with grey swing
60185G	Complete cover for Patty 25 lt, white with brown swing
6020A-10	Big plastic mop holder, blue
6020B-10	Big plastic mop holder, red
6020C-10	Big plastic mop holder, yellow
6020F-10	Big plastic mop holder, green
6020U-10	Grey big plastic mop holder
6041	Cotton bonnet mop, ø 43 cm
6048	Microfiber bonnet mop 13", ø 33 cm
7930AGB	SPIDER - 15 lt single shockproof plastic bucket with divider, blue
7932AGB	Blue bucket 15 L without divider and without wheels for Spider bucket
7990AGB	SPIDER MAX - 15 lt single shockproof plastic bucket with divider, blue
8169E	PATTY - plastic white bin, with brown swing cover, 25 lt

8169G	PATTY - plastic white bin, with grey swing cover, 25 lt
8369	PATTY - plastic bin with bag stretcher and swing cover, white, 25 lt
8369A	PATTY - plastic white bin, with bag stretcher and blue swing cover, 25 lt
8369B	PATTY - plastic white bin, with bag stretcher and red swing cover, 25 lt
8369C	PATTY - plastic white bin, with bag stretcher and yellow swing cover, 25 lt
8369E	PATTY - plastic white bin, with bag stretcher and grey swing cover, 25 lt
8369F	PATTY - plastic white bin, with bag stretcher and green swing cover, 25 lt
8369G	PATTY - plastic white bin, with bag stretcher and brown swing cover, 25 lt
8518/M	SPEEDY polyester-cotton flat mop, polyester backing, looped yarn inside and cut yarn outside, external flaps with 2 holes, 50x16 cm
P119003U	Big central plastic basket with 6 hooks, grey
P190938D	Linking system for Patty 25 lt
P230001B	Round plastic board for conical safety sign, red, "no entry"
R1200113	Lower Rilsan coated bucket holder for 2x 8 L buckets for Vega Top-Down trolley
R1200114	Upper Rilsan coated bucket holder for bucket 8 L for Vega Top-Down trolley
R3090	JUMBO QUICK R3090 - Rilsan coated trolley
R7230	SMART R7230 - Rilsan coated trolley
R7235	SMART R7235 - Rilsan coated trolley
R8090	TEDDY R8090 - Rilsan coated trolley
R8098	TEDDY R8098 - Rilsan coated trolley
7931AGBSS	Bucket for 15 lt Spider bucket with divider and wheels, blue
P290934E	Plastic cover for Sirius bins 30 lt and 60 lt with bag stretcher, cage for deodorant pills and pins, grey

General safety of plastic, metal and mixed products

The items we market do not require product certification, as they correspond to the definition given in Legislative Decree 206 of 06.09.2005.

Based on such decree, a safe product is a product that during normal or reasonably predictable use, including in terms of duration, does not pose any hazards or only minimum hazards, compatible with the use of the product itself.

The items listed above are not within the scope of any of the European Product Directives, in particular they do not fall under the Machinery Directive 93/37/EC, the Low Voltage Directive 73/23/EC or the Electromagnetic Compatibility Directive 89/336/EEC.

Also, no specific risks connected with the cleaning items or systems of relevance have been identified.

The material used are all materials which don't constitute a chemical health hazard to the end users.

The company constantly monitors the materials used, keeping their safety data sheets on file.

As far as safety is concerned, it must be pointed out that the product may not be used by non-professional users, or on non-level surfaces with slopes exceeding 1%.

It is also recommended that the items are stored away from the reach of children.

Lastly, the company shall not be held responsible for any damage caused by the substances used by operators.

Safety of electric items

Our electric items - Aura range - meet the 89/336/EEC Electromagnetic Compatibility Directive and are all CE marked.

Before using electric items, the operator must read the instruction booklet, which must be strictly followed. For any doubts, the operator can refer to the Manufacturer or the available Support Centres.

The materials used for the manufacturing of electric items are all materials that do not pose any chemical hazards for the health of users. The company constantly monitors the materials used, keeping their safety data sheets on file.

Lastly, the manufacturer shall not be held responsible for any damage caused by the operator using the electric items.

Compliance Declaration

All items we market comply with current safety laws and are covered by a "product liability" **insurance policy**.

Floor care and dusting



Dust mopping

Damp mopping

Dustpans

Brooms and brushes

Equipment for wax application

Pad holders

Scrapers

Floor squeegees





- DUST MOPPING
- DAMP MOPPING
- DUSTPANS
- BROOMS AND BRUSHES
- EQUIPMENT FOR WAX APPLICATION
- PAD HOLDERS
- SCRAPERS
- FLOOR SQUEEGEES

Dust mopping with flat mops and the specific mop holders is the ideal system to collect and keep the dust, unlike the household brooms which just raise the dust to let it deposit on the floor again afterwards. Filmop dust mops are available in different sizes from 40 to 160 cm.

YARNS



Natural fiber coming from recycling with thin yarn that effectively removes the smallest particles of dust and dirt, ensuring excellent cleaning results.



100% COTTON



Natural mixed fiber coming from recycling with highly absorbent thick yarn that attracts, captures and keeps dirt, releasing it only during mop washing.



COTTON



Regenerated natural fiber coming from recycling with thin yarn ideal for dusting, as it collects and keeps effectively dust from any surface.



FIRST RATE

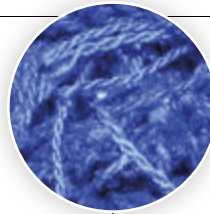

A high electrostatic charged fiber that collects and attracts dust particles, thus increasing the performances of the mop.



ACRYLIC



Microfiber is a synthetic fiber that penetrates into the microporosity of the floor, retaining the dirt removed and releasing it only during machine washing.



RAPIDO SUPER EXTRA



Please, refer to pages 28-29 for washing instructions.

KIND OF SUPPORT



Strings



Pockets



Buttons



Strap tape system



- DUST MOPPING
- DAMP MOPPING
- DUSTPANS
- BROOMS AND BRUSHES
- EQUIPMENT FOR WAX APPLICATION
- PAD HOLDERS
- SCRAPERS
- FLOOR SQUEEGEES

Dust mops

100% cotton mop with buttons



REF.	NOTES	SIZE (cm) ↓ ↓ ↓
5141		40x12
5161		60x12
5181		80x12
5111		100x12

100% cotton pocket mop



REF.	NOTES	SIZE (cm) ↓ ↓ ↓
5141/1		40x12
5161/1		60x12
5181/1		80x12
5111/1		100x12

Normal cotton mop with buttons



REF.	NOTES	SIZE (cm) ↓ ↓ ↓
5142		40x12
5162		60x12
5182		80x12
5112		100x12

Normal cotton pocket mop



REF.	NOTES	SIZE (cm) ↓ ↓ ↓
5142/1		40x12
5162/1		60x12
5182/1		80x12
5112/1		100x12

Blue acrylic mop with buttons



REF.	NOTES	SIZE (cm) ↓ ↓ ↓
5144		40x12
5164		60x12
5184		80x12
5114		100x12

Blue acrylic pocket mop



REF.	NOTES	SIZE (cm) ↓ ↓ ↓
5144/1		40x12
5164/1		60x12
5184/1		80x12
5114/1		100x12

First rate cotton mop with polyester backing and strings



REF.	NOTES	SIZE (cm) ↓ ↓ ↓
5746		40x12
5766		60x12
5786		80x12
5716		100x12

Blue acrylic mop with polyester backing and strings



REF.	NOTES	SIZE (cm) ↓ ↓ ↓
5147		40x12
5167		60x12
5187		80x12
5117		100x12
5178/2		110x12
5128/2		120x12
5138/2		130x12
5158/2		160x12

100% cotton mop with polyester backing and strings



REF.	NOTES	SIZE (cm) ↓ ↓ ↓
5176/2		110x12
5126/2		120x12
5136/2		130x12
5156/2		160x12

Set of 100% cotton V-sweeper mop with buttons



REF.	NOTES	SIZE (cm) ↓ ↓ ↓
5101	for mop holder art. 5201 - 5201/1	100x12

Set of normal cotton V-sweeper mop with buttons



REF.	NOTES	SIZE (cm) ↓ ↓ ↓
5102	for mop holder art. 5201 - 5201/1	100x12

Set of blue acrylic V-sweeper mop with buttons



REF.	NOTES	SIZE (cm) ↓ ↓ ↓
5104	for mop holder art. 5201 - 5201/1	100x12



Floor care and dusting

- DUST MOPPING**
- DAMP MOPPING
- DUSTPANS
- BROOMS AND BRUSHES
- EQUIPMENT FOR WAX APPLICATION
- PAD HOLDERS
- SCRAPERS
- FLOOR SQUEEGEES

Set of first rate cotton V-sweeper mop with polyester backing and strings



REF.	NOTES	SIZE (cm)
5706	for mop holder art. 5201 - 5201/1	100x12

Set of blue acrylic V-sweeper mop with polyester backing and strings



REF.	NOTES	SIZE (cm)
5107	for mop holder art. 5201 - 5201/1	100x12

RAPIDO SUPER EXTRA - high-performing white microfiber mop for big areas, with backing for strap tape system

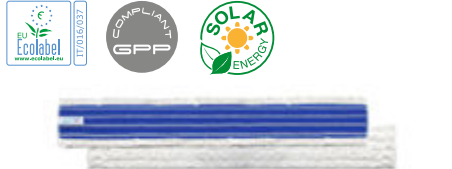

REF.	NOTES	SIZE (cm)
00PN0823A00DA	for mop holder art. 5201/28 and art. 5278	80x10
00PN1023A00DA	for mop holder art. 5201/21 and art. 5278	100x10

Ideal for industrial floors, natural stones, single-fired tiles and stoneware with a medium-high degree of dirt

Mop holders for dust mops

Foldable metal dust mop holder with metal joint

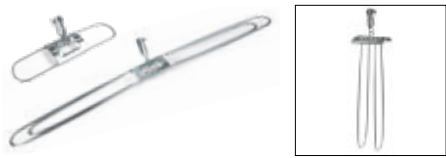

REF.	NOTES	SIZE (cm)
5241		40x9
5261		60x9
5281		80x9
5211	reinforced	100x9

Foldable metal dust mop holder with plastic joint



REF.	NOTES	SIZE (cm)
5241/PA		40x9
5261/PA		60x9
5281/PA		80x9
5211/PA	reinforced	100x9

Foldable dust mop holder with plastic plate and joint

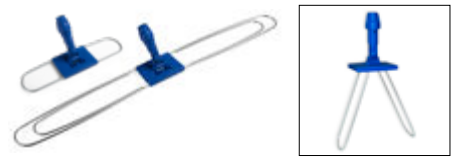

REF.	NOTES	SIZE (cm)
5341A		40x9
5361A		60x9
5381A		80x9
5511A		100x9
5311A	reinforced	100x9

Fixed plastic dust mop holder



REF.	NOTES	SIZE (cm)
5342H		40x9
5362H		60x9

Foldable plastic mop holder with pedal opening device



REF.	NOTES	SIZE (cm)
5540		40x9
5560		60x9

Mop holder for big areas

Fixed metal dust mop holder with two supports



REF.	NOTES	SIZE (cm)
5271		110x9
5221		120x9
5231		130x9
5251		160x9

Fixed metal dust mop holder with plastic joint



REF.	NOTES	SIZE (cm)
5221/PA		120x9
5231/PA		130x9
5251/PA		160x9

Wooden V-sweeper dust mop holder



REF.	NOTES	SIZE (cm)
5201		100x7



- DUST MOPPING
- DAMP MOPPING
- DUSTPANS
- BROOMS AND BRUSHES
- EQUIPMENT FOR WAX APPLICATION
- PAD HOLDERS
- SCRAPERS
- FLOOR SQUEEGEES

Metal V-sweeper dust mop holder



REF.	NOTES	SIZE (cm) ↓ ↓ ↓
5201/1		100x9

Plastic V-sweeper mop holder with strap tape system



REF.	NOTES	SIZE (cm) ↓ ↓ ↓
5201/28A		80x8
5201/21A		100x8

Chromed V-sweeper handle

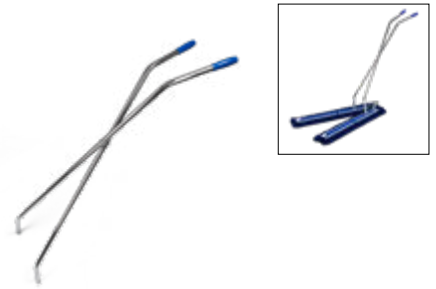

REF.	NOTES	SIZE (cm) ↓ ↓ ↓
5202		134

Chromed V-sweeper handle with central plastic reinforcement



REF.	NOTES	SIZE (cm) ↓ ↓ ↓
5203		134

Articulated plastic connection with screws for V-sweeper handle art.5203

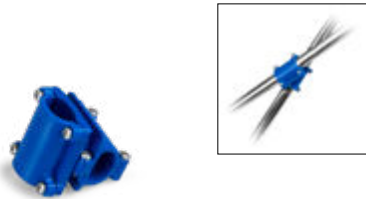

REF.	NOTES
5503	

Complete V-sweeper

Full V-sweeper mop with normal cotton mop with buttons, wooden plate and chromed handle



REF.	PCK
5002SL	5
05002	1

Full V-sweeper mop with normal cotton mop with buttons, iron plate and chromed handle



REF.	PCK
5002SF	5
05002SF	1



DUST MOPPING

DAMP MOPPING

DUSTPANS

BROOMS AND BRUSHES

EQUIPMENT FOR WAX APPLICATION

PAD HOLDERS

SCRAPERS

FLOOR SQUEEGEES

Damp mopping is very important because it allows to collect and keep also the smallest dust particles reducing micro-organisms in the air. Filmop offers systems using mop holders with rubber blades, with foam sole or with strap tape system, combined with pre-soaked cloths or cotton gauzes. The special trapezoidal shaped mop holders allow to clean edges and hard-to-reach areas, they are light and handy.



All Filmop mop holders can be equipped with **Lock System** joint



MOP HOLDERS WITH STRAP TAPE SYSTEM

Thanks to the wide range of accessories, like foam soles, mop and pads, the mop holders with strap tape system can be used for different cleaning operations.



CLOTH HOLDERS WITH RUBBER BLADES OR LAMELLAS

The 30° inclination of the flexible rubber blades allows to collect all dust particles assuring the utmost hygiene also on uneven floors. The cloth holders with rubber blades or lamellas are **washable** and **sterilizable**.



MOP HOLDER WITH FOAM SOLE

The mop holders with foam sole are light and practical, they are suitable also for uneven surfaces. Available in 2 versions: cloth holders with incorporated foam sole or cloth holder with strap tape system with removable foam sole



Unlocked joint: floor mopping

Locked joint: cleaning of walls and ceilings

Cloth holder with rubber blades and with foam sole

SPARK - cloth holder with rubber blades



REF.	NOTES	SIZE (cm) ↓ ↓ ↓
72000A		40x11
72001A		60x11
72002A		80x11

Autoclavable

SPARK - cloth holder with rubber blades, with Lock System

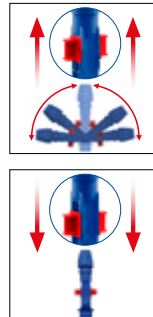

REF.	NOTES	SIZE (cm) ↓ ↓ ↓
73000A		40x11

Autoclavable

SPARK - tool with rubber blades and ErgoSwing joint



REF.	NOTES	SIZE (cm) ↓ ↓ ↓
79000A		40x11
79001A		60x11

Autoclavable - use with ErgoSwing system handle, code 0000AM3045
Learn more about ErgoSwing in the handle section



DUST MOPPING

DAMP MOPPING

DUSTPANS

BROOMS AND BRUSHES

EQUIPMENT FOR WAX APPLICATION

PAD HOLDERS

SCRAPERS

FLOOR SQUEEGEES

SPARK - cloth holder with rubber blades, with Uni-Connect fitting and cone and Lock System

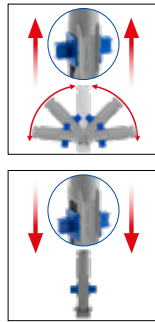

REF.	NOTES	SIZE (cm)
0000TP1813A		40x11

Autoclavable
Learn more about Uni-Connect in the glass and surfaces section

SPARK - cloth holder with rubber blades complete with chromed handle 140 cm - 2 pcs



REF.	NOTES	SIZE (cm)
172000A		40x11
172001A		60x11

FLEXY - cloth holder with rubber blades complete with chromed metal handle 140 cm - 2 pcs



REF.	NOTES	SIZE (cm)
5225A		60x11

Cloth holder with foam sole complete with chromed metal handle 140 cm - 2 pcs



REF.	NOTES	SIZE (cm)
5213A		40x11
5212A		60x11

Cloth holder with foam sole, no handle



REF.	NOTES	SIZE (cm)
100/5213A		40x11
100/5212A		60x11

Cloth holder with strap tape system and replaceable foam sole, complete with chromed handle 140 cm - 2 pcs



REF.	NOTES	SIZE (cm)
5252A		40x11
5254A		60x11

Rapido mop holders

RAPIDO - plastic holder with back fixing hooks



REF.	NOTES	SIZE (cm)
0000TA0001A		40x10

Pad for cloth holder with strap tape system



REF.	NOTES	SIZE (cm)
5224		40x11
5223		60x11



DUST MOPPING

DAMP MOPPING

DUSTPANS

BROOMS AND BRUSHES

EQUIPMENT FOR WAX APPLICATION

PAD HOLDERS

SCRAPERS

FLOOR SQUEEGEES

Components for holders with rubber blades and with foam sole

Plastic joint with articulation



REF.	NOTES
4008A	

Lock System plastic joint



REF.	NOTES
4028AB	

Round cloth star fixing clip



REF.	NOTES
60062U	

Autoclavable round cloth star fixing clip for Spark cloth holders



REF.	NOTES
P191061U	

Foam sole for cloth holder with strap tape system



REF.	NOTES	SIZE (cm)
		↓ ↓ ↓
5247		30
5239		40
5240		60

Cotton gauzes and cloths

Hemmed cotton gauze



REF.	NOTES	SIZE (cm)
		↓ ↓ ↓
5215		60x80
5216		80x100
5219		80x120
5217		80x140
5214		80x180

Polybags with 10 pcs each for products no. 5215 and 5216 and polybags with 5 pcs each for products no. 5219-5217 and 5214.

Cotton gauze in roll h 80 cm



REF.	NOTES
5220	roll 100 mt long

White polypropylene disposable cloth soaked with mineral oil



REF.	NOTES	SIZE (cm)
		↓ ↓ ↓
50002	pck.: 20 polybags with 50 pcs	20x60
50003	pck.: 20 polybags with 50 pcs	30x60
50011	pck.: 12 polybags with 50 pcs	20x85
50004	pck.: 40 polybags with 25 pcs	25x42

Viscose yellow disposable cloth soaked with mineral oil



REF.	NOTES	SIZE (cm)
		↓ ↓ ↓
5206	pck.: 10 polybags with 50 pcs each	20x60
5210	pck.: 10 polybags with 50 pcs each	57x60

Disposable roll cloth made of polypropylene soaked with mineral oil



REF.	NOTES	SIZE (cm)
		↓ ↓ ↓
0000PN0501	pck.: 20 rolls with 50 tears	17x60
0000PN0502	pck.: 20 rolls with 50 tears	20x60

QUIK-STIK - Viscose and polyester disposable cloth with glue



REF.	NOTES	SIZE (cm)
		↓ ↓ ↓
00PU0101000	Pkg: 8 rolls with 50 tears	20x60



DUST MOPPING

DAMP MOPPING

DUSTPANS

BROOMS AND BRUSHES

EQUIPMENT FOR WAX APPLICATION

PAD HOLDERS

SCRAPERS

FLOOR SQUEEGEES

Dry-Up, the high absorbent disposable cloth made by Filmop, lets you solve any loss of liquid instantly: thanks to its performances, surfaces dry very quickly with the highest hygiene, allowing to continue with the ongoing activities.



- **High absorbency in a few seconds:** the high absorbing polymers of the cloth soak up till 1000 ml from 30 to 150 seconds. Absorbing time and capacity depend on the type of liquid: Dry-Up can indeed absorb water, drinks, chlorine bleach, oil, urine and blood.
- **Maximum safety and hygiene:** the absorbed liquid is bonded safe in the cloth and transformed into gel, allowing a safe and hygienic disposal of the cloth, neither dripping nor trickle, and avoiding cross contamination.
- **High versatility:** perfect to be used in healthcare facilities, elderly homes, restaurants, bars, supermarkets, communities, schools, airports, public toilets, industries, mechanical workshops.



YouTube



Put Dry-Up onto the leakage of liquid and wait until it absorbs it completely. If necessary, move it slightly without lifting it to absorb the rest of the liquid. Do not step on it, because it could be slippery.



Remove Dry-Up. The liquid, now transformed into gel, is bonded safe in the cloth, avoiding dripping and trickling. Dry-Up leaves the surface completely dry, allowing a fast restart of ongoing activities.



Dispose of the cloth as general waste (please, comply with the specific protocol for hospital waste). Then proceed with the cleaning of the area.

DRY-UP - super-absorbent disposable cloth

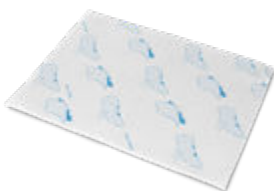

REF.	NOTES	SIZE (cm)
0000PN02060		45x33 ↓ ↓ ↓
0000PN02069	pck.: 5 polybags with 10 pcs	45x33



DUST MOPPING

DAMP MOPPING

DUSTPANS

BROOMS AND BRUSHES

EQUIPMENT FOR WAX APPLICATION

PAD HOLDERS

SCRAPERS

FLOOR SQUEEGEES

Jobby with telescopic handle

Jobby dustbin is also available with an aluminium **telescopic handle** to facilitate collection operations and protect health.

The possibility of adjusting the length of the handle on the basis of the height of the operator prevents the onset of occupational diseases due to the repeated assumption of incorrect postures.



Handle adjustment

Pocker dustpan with wheels

The Pocker dustpan has a practical **handle** and 80 mm **wheels** for better ergonomics and practicality of use and transport.

Pocker is also available in the **4-wheel version** for easier manoeuvrability and handling, particularly during the collection of waste.



Ergonomic push-grip

Dustpans with floor squeegee

KIT BAGGY - dustpan with rubber profile, foldable grip, floor squeegee with rubber blade and no. 10 bags 50x60 cm



REF.

NOTES

0000PA20400

BAGGY - dustpan with rubber profile, foldable grip, aluminium handle and bag fixing device, h 82 cm



REF.

NOTES

0000PA10400

KIT BAGGY - dustpan with rubber profile, floor squeegee with rubber blade and no. 10 bags 50x60 cm



REF.

NOTES

0000PA20300



DUST MOPPING

DAMP MOPPING

DUSTPANS

BROOMS AND BRUSHES

EQUIPMENT FOR WAX APPLICATION

PAD HOLDERS

SCRAPERS

FLOOR SQUEEGEES

BAGGY - dustpan with rubber profile, aluminium handle, bag fixing device, plastic grip with handle support - h 82 cm



REF.	NOTES
0000PA10300	

Floor squeegee for Baggy dustpan 32 cm with aluminium handle - h 96 cm



REF.	NOTES
0000SC10200	

Floor squeegee for Baggy dustpan 32 cm, no handle



REF.	NOTES
0000SC00200	

Set of 10 bags 50x60 cm for Baggy dustpan



REF.	NOTES
SAC025	

Floor squeegee 55 cm with joint, no handle



REF.	NOTES
0000SC00211	

Attaching the cloth TCH120020, the tool can be used for washing floors - The cloth is attached using two clips code 8220/1

Dustpans with brooms

JOBBY - plastic coloured dustpan with aluminium telescopic handle, without cover



REF.	NOTES	SIZE (cm)
000010124A		29x28x67
000010124H		29x28x67

With serrated edge for an easy removal of the dirt from the broom - Dustbin height: adjustable from 67 to 102 cm

JOBBY - plastic coloured dustpan with aluminium telescopic handle and black cover



REF.	NOTES	SIZE (cm)
000010125A		29x28x67
000010125H		29x28x67

With serrated edge for an easy removal of the dirt from the broom - Dustbin height: adjustable from 67 to 102 cm



Floor care and dusting

DUST MOPPING

DAMP MOPPING

DUSTPANS

BROOMS AND BRUSHES

EQUIPMENT FOR WAX APPLICATION

PAD HOLDERS

SCRAPERS

FLOOR SQUEEGEES

JOBBY - plastic coloured dustpan with aluminium handle and foldable grip, without cover



REF.	NOTES	SIZE (cm) ↓ ↓ ↓
000010404A		29x28x87,5
000010404B		29x28x87,5
000010404H		29x28x87,5

With serrated edge for an easy removal of the dirt from the broom

JOBBY - plastic coloured dustpan with aluminium handle, foldable grip and black cover



REF.	NOTES	SIZE (cm) ↓ ↓ ↓
000010405A		29x28x87,5
000010405B		29x28x87,5
000010405H		29x98x87,5

With serrated edge for an easy removal of the dirt from the broom

JOBBY - plastic coloured dustpan with aluminium handle, without cover



REF.	NOTES	SIZE (cm) ↓ ↓ ↓
000010104A		29x28x87,5
000010104B		29x28x87,5
000010104C		29x28x87,5
000010104F		29x28x87,5
000010104H		29x28x87,5

With serrated edge for an easy removal of the dirt from the broom

JOBBY - plastic coloured dustpan with aluminium handle and black cover

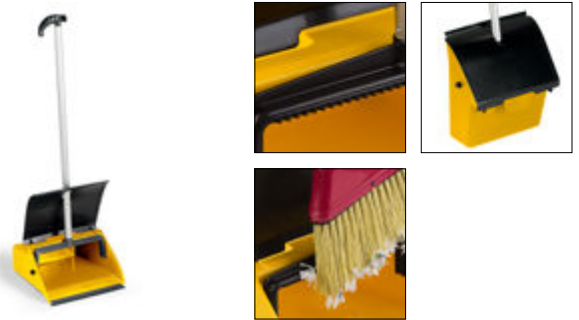

REF.	NOTES	SIZE (cm) ↓ ↓ ↓
000010105A		29x28x87,5
000010105B		29x28x87,5
000010105C		29x28x87,5
000010105F		29x28x87,5
000010105H		29x28x87,5
000010105U		29x28x87,5

With serrated edge for an easy removal of the dirt from the broom

Broom with handle 80 cm for Jobby dustpan



REF.	NOTES	SIZE (cm) ↓ ↓ ↓
0000SC01030		25x5x100

Broom with telescopic handle 65-110 cm for Jobby dustpan



REF.	NOTES
0000SC01040	



DUST MOPPING

DAMP MOPPING

DUSTPANS

BROOMS AND BRUSHES

EQUIPMENT FOR WAX APPLICATION

PAD HOLDERS

SCRAPERS

FLOOR SQUEEGEES

Metal dustpan with handle



REF.	NOTES	SIZE (cm) ↓ ↓ ↓
0000VA01010		26x35x75

VERDE - polypropylene broom with wooden handle 110 cm



REF.	NOTES	SIZE (cm) ↓ ↓ ↓
9045		

Plastic dustpan with rubber profile and grip



REF.	NOTES	SIZE (cm) ↓ ↓ ↓
0000PA01020U		20x31x7

POCKER - dustpan 15 L with 2 wheels ø 80 mm and ergonomic grip



REF.	NOTES	SIZE (cm) ↓ ↓ ↓
000010100YU		20x32x91

POCKER-4 - dustpan 15 L with 4 wheels ø 80 mm and ergonomic grip



REF.	NOTES	SIZE (cm) ↓ ↓ ↓
000020100YU		20x32x91

Nipper for safe waste pick-up



REF.	NOTES	SIZE (cm) ↓ ↓ ↓
9122		100
9121		40

Ideal for the safety collection of syringes, broken glass and similar

Industrial brooms and brushes

STREET - polypropylene broom, no handle



REF.	NOTES	SIZE (cm) ↓ ↓ ↓
9039	Weight: 700 gr.	

Fitting handle art. 1070

Industrial broom, stiff nylon with Italian thread



REF.	NOTES	SIZE (cm) ↓ ↓ ↓
9020		33

Fitting handle art. 0000LM30023



DUST MOPPING

DAMP MOPPING

DUSTPANS

BROOMS AND BRUSHES

EQUIPMENT FOR WAX APPLICATION

PAD HOLDERS

SCRAPERS

FLOOR SQUEEGEES

Industrial push broom in rigid nylon



REF.	NOTES	SIZE (cm) ↓ ↓ ↓
9021		60
9025		100

Fitting handle art. 1057

Industrial push broom in coconut



REF.	NOTES	SIZE (cm) ↓ ↓ ↓
9022		60
9026		100

Fitting handle art. 1057

Industrial push broom in soft waved nylon



REF.	NOTES	SIZE (cm) ↓ ↓ ↓
9028		60
9029		100

Fitting handle art. 1057

Industrial push broom with external soft bristles and internal hard bristles with ring

NEW



REF.	NOTES	SIZE (cm) ↓ ↓ ↓
9034		30
9035		45
9036		60

Industrial broom hard bristles with ring

NEW

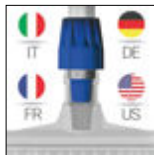

REF.	NOTES	SIZE (cm) ↓ ↓ ↓
9038		36x7x22

Industrial broom soft bristles with ring

NEW

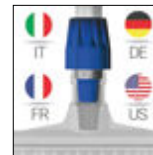

REF.	NOTES	SIZE (cm) ↓ ↓ ↓
9037		34x7,5x19

Industrial high broom hard bristles with ring

NEW



REF.	NOTES	SIZE (cm) ↓ ↓ ↓
9047		35x5x26,5

FUGINATOR - Tile grout cleaning brush



Food contact

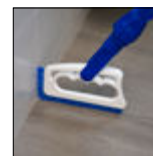

REF.	NOTES	SIZE (cm) ↓ ↓ ↓
0000GI2004A	with manual handle	1,7x15,7x8
0000GI2104A	with joint	4,5x15,7x22

Autoclavable up to 120° C - Fitting telescopic handle ref.0000AM3060A and Drop tank handle ref. 0000TD0600A - Product suitable for contact with food in accordance with European regulations (EC Regulation 1935/2004 and EU Regulation No. 10/2011) - Compliance Declaration attached to the technical sheet



DUST MOPPING

DAMP MOPPING

DUSTPANS

BROOMS AND BRUSHES

EQUIPMENT FOR WAX APPLICATION

PAD HOLDERS

SCRAPERS

FLOOR SQUEEGEES

Household articles

BRILLO - cloth holder for pre-soaked cloths with a set of 25 cloths 25x42 cm



REF.	NOTES
5253A	pck. hang-up bag

Pre-soaked cloths for Brillo



REF.	NOTES
5248	pck. hang-up bag with 25 pcs

GIADA - Plastic broom with Italian thread



REF.	NOTES
9041	
It can be used with handle art. 0000LM30023, art. 1059, art. 0000AM30010 and art. 0000AM30020	

PVC broom with bumpers with Italian thread



REF.	NOTES	SIZE (cm)
9044		8x34x11
It can be used with handle art. 0000LM30023, art. 1059, art. 0000AM30010 and art. 0000AM30020		

Wax applicator tools

SLIDER - wax applicator with tank 1,5 L and sleeve 40 cm



REF.	NOTES
8150	

UNILAV SIDE GRIP - tool for wax application with refilling bottle 1 L, Rapido cloth holder and Smart-Fur microfiber mop



REF.	NOTES
0002TD1147A	

Available while stocks last



DUST MOPPING

DAMP MOPPING

DUSTPANS

BROOMS AND BRUSHES

EQUIPMENT FOR WAX APPLICATION

PAD HOLDERS

SCRAPERS

FLOOR SQUEEGEES

Mops for wax application

RAPIDO - plastic holder with back fixing hooks



REF.	NOTES	SIZE (cm) ↓ ↓ ↓
0000TA0001A		40x10

SMART-FUR - bordered microfiber mop with backing for strap tape system and colour-coded tags

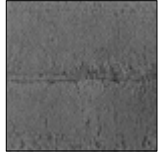

REF.	NOTES	SIZE (cm) ↓ ↓ ↓
00PN0403H00		40
00PN0403H00E		40
00PN0603H00		60
00PN0603H00E		60
00PN0803H00		80
00PN0803H00E		80
00PN1003H00		100
00PN1003H00E		100

Ideal for any kind of surface with medium degree of dirt - The shock-absorbing border guarantees a better protection for and against baseboards and walls

Code 00PN0803H00 available while supplies last

Smart-Fur microfiber jointed sleeve for wax application



REF.	NOTES	SIZE (cm) ↓ ↓ ↓
9430		35
9431		40

Jointed support for wax application



REF.	NOTES	SIZE (cm) ↓ ↓ ↓
9401		35
9147		40

SMART FUR - microfiber sleeve for wax application



REF.	NOTES	SIZE (cm) ↓ ↓ ↓
9421		35
9423		40



DUST MOPPING

DAMP MOPPING

DUSTPANS

BROOMS AND BRUSHES

EQUIPMENT FOR WAX APPLICATION

PAD HOLDERS

SCRAPERS

FLOOR SQUEEGEES

Systems for wax application

Bucket trolley for wax application complete with pushing handle, plastic sieve and sleeve 40 cm



REF.	NOTES	CAPACITY (L)	SIZE (cm) ↓ ↓ ↓
9200/PRO		20	30x74x88

Plastic bucket 20 lt with plastic handle



REF.	NOTES	SIZE (cm) ↓ ↓ ↓
0000SE1222A	Blue	24x55x27
0000SE1222B	Red	24x55x27
0000SE1222U	Grey	24x55x27

Plastic sieve fitting bucket trolley for wax application / window cleaning



REF.	NOTES	SIZE (cm) ↓ ↓ ↓
9206A		8x53x10

For window washer 35 and 40 cm

TWIN - plastic bucket 2x10 L with two plastic handles



REF.	NOTES	SIZE (cm) ↓ ↓ ↓
7914A		36x45x26

Fitting window washer 35 cm

Plastic sieve for Twin bucket



REF.	NOTES
21021A	

Fitting window washer 35 cm

Plastic bucket 28 L with plastic handle



REF.	NOTES	SIZE (cm) ↓ ↓ ↓
0000SE1428A	Blue	32x52x27
0000SE1428B	Red	32x52x27

Pierced plastic sieve for bucket 28 L



REF.	NOTES
P1190043A	

For 40 cm mops and cloths

Plastic cover for bucket 28 L



REF.	NOTES	SIZE (cm) ↓ ↓ ↓
0000CP1128U		33x53x2,8

Wheel ø 50 mm



REF.	NOTES
7949	

For King, Spider, Rocket Wheels, Duo Pro System, Prisma, Twin, Top-Down®, Pick-Up, Trend and code 0000SE1428



DUST MOPPING

DAMP MOPPING

DUSTPANS

BROOMS AND BRUSHES

EQUIPMENT FOR WAX APPLICATION

PAD HOLDERS

SCRAPERS

FLOOR SQUEEGEES

Mop holders and pads

Manual pad holder



REF.	NOTES	SIZE (cm) ↓ ↓ ↓
5228A		10x23

Jointed pad holder



REF.	NOTES	SIZE (cm) ↓ ↓ ↓
5229A		10x23,5

Jointed pad holder with Lock System



REF.	NOTES	SIZE (cm) ↓ ↓ ↓
5329A		10x23,5

Abrasive pad



REF.	NOTES	SIZE (cm) ↓ ↓ ↓
5222		12x25x2
5222F		12x25x2
5222G		12x25x2
5222H		12x25x2

Scrapers and blades

Floor scraper with plastic handgrip with Italian thread



REF.	NOTES
9851	
Compatible with Uni-Connect system	

Floor scraper with aluminium handle



REF.	NOTES
9852	with 25 cm handle
9853	with 120 cm handle

Blades for floor scraper



REF.	NOTES
9654	1 pc art. 9154 = 100 blades



DUST MOPPING

DAMP MOPPING

DUSTPANS

BROOMS AND BRUSHES

EQUIPMENT FOR WAX APPLICATION

PAD HOLDERS

SCRAPERS

FLOOR SQUEEGES

Plastic floor squeegees

Plastic floor squeegee, with white rubber blade and coloured support

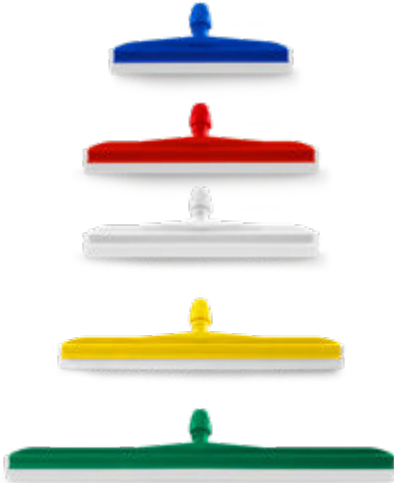

REF.	NOTES	SIZE (cm) ↓ ↓ ↓
00009011AD		35
00009012AD		45
00009012BD		45
00009012CD		45
00009012DD		45
00009012FD		45
00009013AD		55
00009013BD		55
00009013CD		55
00009013DD		55
00009013FD		55
00009014AD		75
00009014BD		75
00009014CD		75
00009014DD		75
00009014FD		75

Plastic floor squeegee with black rubber



REF.	NOTES	SIZE (cm) ↓ ↓ ↓
00009011AH		35
00009012AH		45
00009013AH		55
00009014AH		75

Metal floor squeegee

Metal floor squeegee with black rubber



REF.	NOTES	SIZE (cm) ↓ ↓ ↓
9007		45
9008		55
9009		75



Floor cleaning

Mop system

Tab system

Pocket system

Pocket-tab system

Strap tape system

Globo system

Duo Face system

Dosing handles





- MOP SYSTEM
- TAB SYSTEM
- POCKET SYSTEM
- POCKET-TAB SYSTEM
- STRAP TAPE SYSTEM
- GLOBO SYSTEM
- DUO FACE SYSTEM
- DOSING HANDLES

YARNS



Natural highly absorbing fiber. Available in Open-end cotton. Fitting all kinds of inside floors.



COTON



String mop made of microfibre stripes with high absorbing power, it glides easily on the surfaces ensuring an effective cleaning. Fitting all kinds of inside floors.



STRIPE MOP



Microfibre mop with high absorbing power, it penetrates into the micropores of the floor, cleaning and thoroughly degreasing it. Fitting all kinds of inside floors.



DREAM MOP



Mop made of synthetic fiber, it cleans effectively and assures a high washing autonomy. Great resistance to aggressive chemicals such as chlorine and hypochlorite. Advised for food and chemical industry.



SYNTHETIC MOP



Please, refer to pages 28-29 for washing instructions.

YARN MANUFACTURING PROCESS



LOOPED YARN

It grants a longer life of the mop: this yarn processing prevents from mop fraying and linting.



TWISTED YARN

It guarantees a more compact yarn making easier the cleaning operations.



BAND

It guarantees a uniform distribution of the mop strings on the floor and avoids getting trapped into possible obstacles in the cleaning area.

KIND OF SUPPORT



5 cm support.



8 cm support.

EU ECOLABEL CERTIFIED PRODUCTS

Filmop International has obtained for the line of mops **mop Open-end** and **Master Lux** the prestigious **Ecolabel UE** certification, the European Union eco-label that rewards **best eco-friendly products**.

The certification attests the **low environmental impact** of the products after having analyzed their sustainability throughout their entire life cycle through a series of very selective parameters, established by the European Community.



OPEN-END COTTON MOP

MASTER LUX THICK YARN



MOP SYSTEM

TAB SYSTEM

POCKET SYSTEM

POCKET-TAB SYSTEM

STRAP TAPE SYSTEM

GLOBO SYSTEM

DUO FACE SYSTEM

DOSING HANDLES

Mops

Open-end cotton mop with 8 cm support



REF.	NOTES	WEIGHT (gr)
000E6013		350
000E6014		400
000E6109		460
000E6110		500

Open-end cotton mop with band and 8 cm support



REF.	NOTES	WEIGHT (gr)
000E6015		350
000E6016		400
000E6112		460
000E6113		500

Open-end cotton mop with 5 cm support



REF.	NOTES	WEIGHT (gr)
6000		350
6001		400

Open-end cotton mop, looped yarn



REF.	NOTES	WEIGHT (gr)
6030		400

Open-end cotton mop, looped yarn, with band



REF.	NOTES	WEIGHT (gr)
6035		400
6036		460

Open-end cotton mop with coloured yarn



REF.	NOTES	WEIGHT (gr)
6050A		400
6050F		400

White synthetic mop with coloured support



REF.	NOTES
6201D	with white support
6201DA	with blue support
6201DB	with red support
6201DC	with yellow support
6201DF	with green support

White synthetic mop with coloured band and coloured support



REF.	NOTES
6211D	with white band and white support
6211DA	with blue band and blue support
6211DB	with red band and red support
6211DC	with yellow band and yellow support
6211DF	with green band and green support

Synthetic mop, twisted yarn



REF.	NOTES
6202D	with white support
6202DA	with blue support
6202DB	with red support
6202DC	with yellow support
6202DF	with green support



- MOP SYSTEM
- TAB SYSTEM
- POCKET SYSTEM
- POCKET-TAB SYSTEM
- STRAP TAPE SYSTEM
- GLOBO SYSTEM
- DUO FACE SYSTEM
- DOSING HANDLES

DREAM MOP - white-blue microfiber mop, looped yarn



REF.	NOTES	WEIGHT (gr)
6205D		350
6204D		400

STRIPE MOP - String mop made of blue microfiber stripes, looped yarn



REF.	NOTES	WEIGHT (gr)
6206A		240

STRIPE MOP - String mop made of colored microfiber stripes



REF.	NOTES	WEIGHT (gr)
6207A	■	250
6207B	■	250
6207C	■	250
6207F	■	250
6208A	■	350

Mop holders

Plastic mop holder with fixing clip for mop, big size



REF.	NOTES
6020U/1-10	■
6020A/1-10	■
6020B/1-10	■
6020C/1-10	■
6020F/1-10	■

Bags for mop washing

White polyester mesh bag with rubber string



REF.	NOTES	CAPACITY (L)	SIZE (cm)
6073		70	90x77
6074		90	95x95

Mesh bag with closing string



REF.	NOTES	CAPACITY (L)	SIZE (cm)
0000AT0210A	polyester ■	30	30x60
0000AT0210B	polyester ■	30	30x60
0000AT0210C	polyester ■	30	30x60
0000AT0210F	polyester ■	30	30x60
0000AT0211A	polyester ■	50	30x90
0000AT0211B	polyester ■	50	30x90
0000AT0212A	stabilized polyester ■	70	60x90
0000AT0212B	stabilized polyester ■	70	60x90
0000AT0214B	stabilized polyester ■	35	65x46

Ideal for supports art. P1909914U, P1909926U and P1909927U



MOP SYSTEM

TAB SYSTEM

POCKET SYSTEM

POCKET-TAB SYSTEM

STRAP TAPE SYSTEM

GLOBO SYSTEM

DUO FACE SYSTEM

DOSING HANDLES

Master Lux universal screw

MASTER LUX - cotton mop with thick yarn, plastic support with universal thread

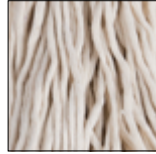

REF.	NOTES	WEIGHT (gr)
000E2036	with grey plastic support	220
000E2036B	with red plastic support	220
000E2037	with grey plastic support	280
000E2037B	with red plastic support	280
000E2037C	with yellow plastic support	280
000E2037F	with green plastic support	280
000E2045	with grey plastic support	400

MASTER LUX - cotton mop with thick yarn, looped yarn, plastic support with universal thread



REF.	NOTES	WEIGHT (gr)
3036	with blue plastic support	220
3037	with blue plastic support	280

MASTER LUX - cotton mop with thin yarn, plastic support with universal thread



REF.	NOTES	WEIGHT (gr)
2039	with blue plastic support	220
2040	with blue plastic support	280
2040B	with red plastic support	280
2040C	with yellow plastic support	280
2040F	with green plastic support	280
2046	with blue plastic support	330

MASTER LUX - synthetic mop, plastic support with universal thread



REF.	NOTES	
6300D	white, with blue plastic support	
6300B	white, with red plastic fitting	
6300C	white, with yellow plastic fitting	
6300F	white, with green plastic fitting	

MASTER LUX - synthetic white mop, twisted yarn, plastic support with universal thread

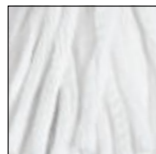

REF.	NOTES	
6400D	with blue plastic support	
6400B	with red plastic support	
6400C	with yellow plastic support	
6400F	with green plastic support	

DREAM MOP - white-blue microfiber mop, looped yarn, plastic support with universal thread



REF.	NOTES	
6310D	with blue plastic support	
6310B	with red plastic support	
6310C	with yellow plastic support	
6310F	with green plastic support	



- MOP SYSTEM
- TAB SYSTEM
- POCKET SYSTEM
- POCKET-TAB SYSTEM
- STRAP TAPE SYSTEM
- GLOBO SYSTEM
- DUO FACE SYSTEM
- DOSING HANDLES

STRIPE MOP - mop made of microfiber stripes, plastic support with universal thread



REF.	NOTES	WEIGHT (gr)
6320A		200
6320B		200
6320C		200
6320F		200

Moppy

MOPPY - cotton mop with thin yarn



REF.	NOTES	WEIGHT (gr)
0000M02230		220
0000M02530		250

Plastic mop holder with ring for Moppy



REF.	NOTES
6025U	

Bonnet mops

Microfiber bonnet mop



REF.	NOTES
0000D225000	ø 25 cm - 10"
0000D235000	ø 35 cm - 14"
6047	ø 43 cm - 17"
0000D253000	ø 53 cm - 21"

Available while stocks last

Cotton bonnet mop, double sided



REF.	NOTES
6042	ø 33 cm

Available while stocks last



Microfiber: the cleaning ally

Microfiber is a **fiber with a fineness of 1 decitex or less**, equivalent to **1 gram per 10 km of yarn**.

It is obtained from synthetic yarns such as polyester, polyamide, viscose or polypropylene, whose fibers are divided into **countless filaments a hundred times thinner than a hair**. The very thin thickness allows the filaments to **reach into every porosity of the surface, removing even the smallest particle of dirt** with ease.

In addition, the incredible capillarity that characterizes the microfiber determines a significantly **higher absorbency than traditional yarns**, ensuring a wide floor covering.

The synthetic fibres used to make microfiber products develop a static charge by friction which **attracts and traps dust**.

A high percentage of **polyester** in the microfiber textiles increases its effectiveness: it **removes greasy dirt completely**, leaving the surface perfectly clean.



Ultra-microfiber: the evolution of the yarn

Ultra-microfiber offers the same advantages as microfiber but differs in the **extremely thin size of the yarn** which is greatly reduced in thickness.

The incredibly small size exponentially **multiplies the points of contact** of the textile with the surface, ensuring truly **unrivaled cleanliness**.

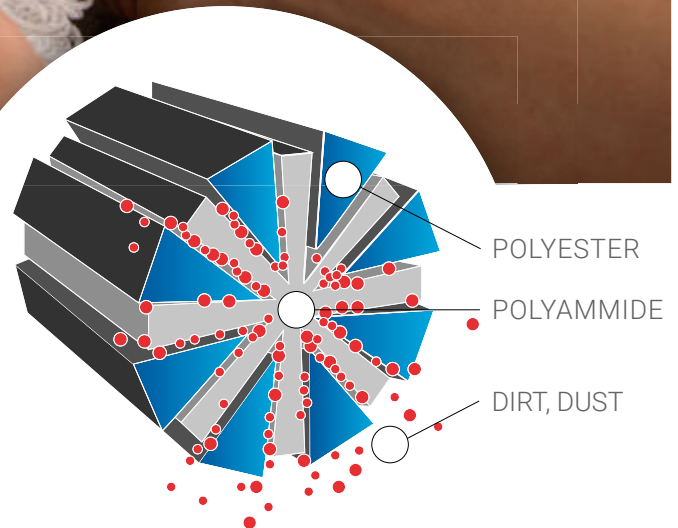

DEEP
CLEANING



EFFECTIVE
DUSTING

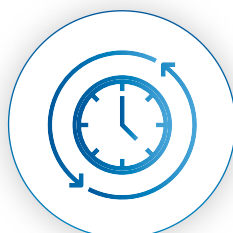

LONG
LASTING



COST
REDUCTION



LOW
ENVIRONMENTAL
IMPACT



Fighting viruses with Filmop microfibers

Cleaning is a **key point in preventing the spread of viruses**, so the equipment used must be up to the delicate task it is called upon to perform. For this reason, Filmop decided to arrange for an external microbiology laboratory to test the viral removal capacity of different types of mops.

Microfibers for floors **Rapido, Rapido Super Extra, A-B Plus, Micro-Activa, Wash Basic and Active-Fur**, disposable microfiber **Mono-Tex** and microfiber for surfaces **Eco Multi-T** have **passed with flying colors the rigorous test** carried out by the independent laboratory: the analysis revealed efficacy in viral removal by all tested textiles moistened with only sterile water before their use. In particular, the test showed a **removal of Human Coronavirus 229E from steel surfaces by up to 99.9%**, establishing the undoubted ability of Filmop microfibers to effectively fight the spread of viruses.





Filmop yarns



Natural highly absorbing fiber that keeps dirt, releasing it only during the washing of the mop. Ideal for all inside floors with a medium degree of dirt.

COTON

70% Cotton - 30% Polyester



The combination of cotton, a natural fiber with a high absorbing level, and polyester, a synthetic fiber very strong and resistant to washings, guarantees a perfect running of the mop on the floor. Ideal for all inside floors with a medium degree of dirt.

POLYESTER-COTTON

70% Polyester - 30% Cotton



Microfiber is a synthetic fiber which penetrates deep into the grooves and pores of floors, absorbing the removed dirt and retaining it till mop washing. Ideal for dusting and washing industrial floors, natural stone, single-fired tiles and stoneware with medium to high dirt degree.

RAPIDO

80% Microfiber (100% Polyester) + 20% Polyamide



Microfiber provides deeper cleaning, greater efficiency and gliding thanks to its fibers that penetrate more easily into the microporosity of the floor. Ideal for washing any type of interior floor with medium to high dirt degree.

RAPIDO SUPER

100% Microfiber (80% Polyester - 20% Polyamide)



High-performance **microfiber** designed to assure deep cleaning and high glide even on porous surfaces. Ideal for washing industrial floors, natural stone, single-fired tiles and stoneware with medium to high dirt degree.

RAPIDO SUPER EXTRA

100% Microfiber (80% Polyester - 20% Polyamide)



Microfiber with high cleaning power and high absorbency that guarantees an excellent cleaning result, even with intense dirt. Ideal for washing any type of floor, both continuous and tiled with joints, with a medium-high degree of dirt.

TWIST-TUFT

100% Microfiber (80% Polyester - 20% Polyamide)



Microfiber better releases the micro-particles of dirt, cotton improves the absorbing capacity of the mop, covering more washable square meter, while polyester allows an easier running of the mop on the floors. Ideal for all inside floors with a medium-high degree of dirt.

TRIPLO

70% Polyester - 30% Cotton

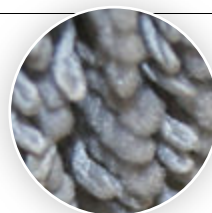

The **ultra-microfiber AB-Plus**, thanks to the special antibacterial treatment with silver ions, is ideal to avoid the proliferation of bacteria and cross-contamination. It eliminates up to 99.98% of bacteria and inhibits their growth thanks to the electrostatic action. Ideal for washing hospital interior floors with a medium degree of dirt.

ANTIBACTERIAL ULTRA-MICROFIBER

75% Ultra-Microfiber (80% Polyester - 20% Polyamide) + 25% Polyester



MOP SYSTEM

TAB SYSTEM

POCKET SYSTEM

POCKET-TAB SYSTEM

STRAP TAPE SYSTEM

GLOBO SYSTEM

DUO FACE SYSTEM

DOSING HANDLES

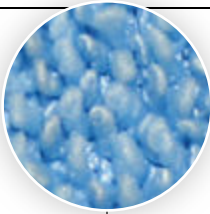

Ultra-microfiber characterized by high absorbency and excellent glide, requires little mechanical friction on the floor and cleans effectively and deeply. Ideal for frequent washing of industrial, single-fired, stoneware and wood floors with a medium degree of dirt.



MICRO-ACTIVA

75% Ultra-Microfiber (80% Polyester - 20% Polyamide) + 25% Polyester

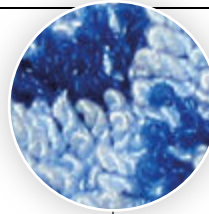

Ultra-microfiber with polypropylene inserts that allow the removal of the most difficult dirt while offering excellent glide. Ideal for scrubbing and washing non-slip floors and natural terracotta with a medium degree of dirt, characterized by stubborn dirt.



PULI-SCRUB

70% Ultra-Microfiber (71% Polyester - 29% Polyamide) + 30% Polypropylene

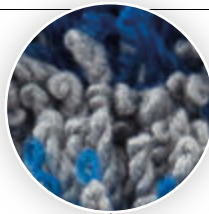

Ultra-microfiber with polypropylene inserts that allow the removal of the most difficult dirt while offering excellent glide. It is characterized by its high absorbent power. Ideal for scrubbing and washing non-slip floors and natural terracotta with medium to high level of dirt, characterized by stubborn dirt.



PULI-SCRUB PLUS

70% Ultra-Microfiber (71% Polyester - 29% Polyamide) + 30% Polypropylene

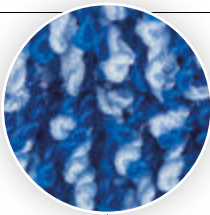

It provides excellent glide and fast, effective cleaning due to its special **ultra-microfiber** and polypropylene composition. Ideal for scrubbing and washing non-slip floors and natural terracotta with a high level of dirt, characterized by stubborn dirt.



PULI-BRUSH

50% Ultra-Mikrofaser (80% Polyester - 20% Polyamid) + 50% Polypropylen

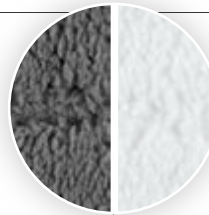

Thanks to the small size of the yarn and the high electrostatic power, the **microfiber** has a mechanical action on the molecules of dirt removing them and trapping them between the fibers. Ideal for spray cleaning and dusting on any kind of floor with medium degree of dirt.

SMART-FUR

100% Polyester Microfiber



Microfiber with nylon inserts for a lower mop friction and a better dirt collection. Ideal for light scrubbing and washing of industrial, single-fired, stoneware and wood floors with a medium degree of dirt.

ACTIVE-FUR

85% Microfibr (100% Poliestere) + 15% Poliammide

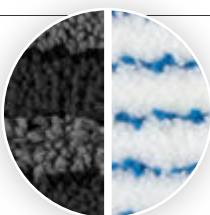

Microfibre with stripes, whose composition offers a perfect balance between cleaning power and mop friction. Ideal for washing industrial, single-fired and stoneware floors with low dirt degree.

SKILL-FUR

60% Microfiber (100% Polyester) + 40% Polyester



For perfect textile care, a washing temperature of 60°C, maximum 95°C, is recommended.

Please, refer to pages 28-29 for washing instructions.



MOP SYSTEM

TAB SYSTEM

POCKET SYSTEM

POCKET-TAB SYSTEM

STRAP TAPE SYSTEM

GLOBO SYSTEM

DUO FACE SYSTEM

DOSING HANDLES

Filmop is the first Italian company designing and producing an innovative floor flat mopping system, overcoming the traditional ones employing string mops. Filmop has conceived a new mopping system based on a flat plastic mop holder, named **Speedy Mop holder**[®], to increase the size of the cleaning tool mopping the floor with important advantages in terms of time and collection of dirt. Moreover, Speedy mop holders are foldable allowing to wring the mop without dropping it from the mop holder.



All Filmop mop holders can be equipped with **Lock System** joint



Spin the mop holder and let it drop onto the floor to open it



Unlocked joint: floor mopping

Locked joint: cleaning of walls and ceilings

Speedy mop holders

SPEEDY MOP HOLDER[®] - foldable plastic mop holder



REF.	NOTES	SIZE (cm)
00008116AB		40x11
8125AB		50x13

SPEEDY MOP HOLDER[®] - foldable plastic mop holder with Lock System fitting

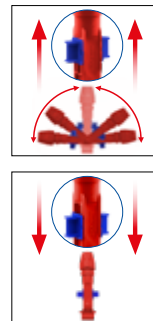

REF.	NOTES	SIZE (cm)
00008316AB		40x11

SPEEDY MOP HOLDER[®] - plastic foldable mop holder with ErgoSwing fitting



REF.	NOTES	SIZE (cm)
00008916AB		40x11

Use with ErgoSwing system handle, code 0000AM3045
Learn more about ErgoSwing in the handle section



MOP SYSTEM

TAB SYSTEM

POCKET SYSTEM

POCKET-TAB SYSTEM

STRAP TAPE SYSTEM

GLOBO SYSTEM

DUO FACE SYSTEM

DOSING HANDLES

Speedy mops

Mop **SPEEDY** polyester and cotton, polyester backing, looped yarn, with flaps 2 holes



REF.	NOTES	SIZE (cm) ↓ ↓ ↓
8414	for 40 x 11 cm mop holders	40x13
8420	for mop holders 50 x 13 cm	50x16

Ideal for any surface with medium dirt - Mops with colored borders available on request - Contact our offices for minimum quantity

Mop **SPEEDY** polyester and cotton, polyester backing, looped yarn inside and cut yarn outside, with flaps 2 holes



REF.	NOTES	SIZE (cm) ↓ ↓ ↓
8414/M	for 40 x 11 cm mop holders	40x13
8420/M	for mop holders 50 x 13 cm	50x16

Ideal for any surface with medium dirt - Mops with colored borders available on request - Contact our offices for minimum quantity

Mop **SPEEDY** cotton, polyester backing, looped yarn, with flaps 2 holes



REF.	NOTES	SIZE (cm) ↓ ↓ ↓
0C08414	for 40 x 11 cm mop holders	40x13
0C08420	for mop holders 50 x 13 cm	50x16

Ideal for any surface with medium dirt - Mops with colored borders available on request - Contact our offices for minimum quantity

Mop **SPEEDY** cotton, polyester backing, looped yarn inside and cut yarn outside, with flaps 2 holes



REF.	NOTES	SIZE (cm) ↓ ↓ ↓
0C08414/M	for 40 x 11 cm mop holders	40x13
0C08420/M	for mop holders 50 x 13 cm	50x16

Ideal for any surface with medium dirt - Mops with colored borders available on request - Contact our offices for minimum quantity

Mop **SPEEDY** polyester and cotton, polyester backing, looped yarn inside and cut yarn outside, with external flaps 2 holes



REF.	NOTES	SIZE (cm) ↓ ↓ ↓
8511/M	for 40 x 11 cm mop holders	40x13

Ideal for any surface with medium dirt

Mop **SPEEDY** polyester and cotton, polyester backing, looped yarn, with external flaps 2 holes



REF.	NOTES	SIZE (cm) ↓ ↓ ↓
8511	for 40 x 11 cm mop holders	40x13

Ideal for any surface with medium dirt



MOP SYSTEM

TAB SYSTEM

POCKET SYSTEM

POCKET-TAB SYSTEM

STRAP TAPE SYSTEM

GLOBO SYSTEM

DUO FACE SYSTEM

DOSING HANDLES

Mop **SPEEDY** cotton, polyester backing, looped yarn inside and cut yarn outside, with external flaps 2 holes

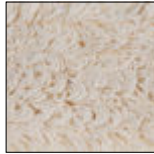

REF.	NOTES	SIZE (cm) ↓ ↓ ↓
0C08511/M	for 40 x 11 cm mop holders	40x13

Ideal for any surface with medium dirt

Mop **SPEEDY** cotton, polyester backing, looped yarn, with external flaps 2 holes



REF.	NOTES	SIZE (cm) ↓ ↓ ↓
0C08511	for 40 x 11 cm mop holders	40x13

Ideal for any surface with medium dirt

Mop **SPEEDY RAPIDO** microfiber, polyester backing, looped yarn, with flaps 2 holes



REF.	NOTES	SIZE (cm) ↓ ↓ ↓
0000121D	for 40 x 11 cm mop holders	40x13
0000611D	for mop holders 50 x 13 cm	50x16

Ideal for industrial floors, natural stones, single-fired tiles and stoneware with a medium-high degree of dirt

Mop **SPEEDY RAPIDO** coloured microfiber, polyester backing, looped yarn, with flaps 2 holes



REF.	NOTES	SIZE (cm) ↓ ↓ ↓
0000121AA	for 40 x 11 cm mop holders	40x13
0000121BB	for 40 x 11 cm mop holders	40x13
0000121CC	for 40 x 11 cm mop holders	40x13
0000121FF	for 40 x 11 cm mop holders	40x13

Ideal for industrial floors, natural stones, single-fired tiles and stoneware with a medium-high degree of dirt

SPEEDY RAPIDO microfiber mop, polyester backing, looped yarn, with external flaps 2 holes

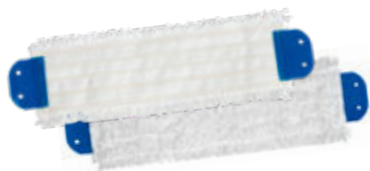

REF.	NOTES	SIZE (cm) ↓ ↓ ↓
8516	for 40 x 11 cm mop holders	40x13

Ideal for industrial floors, natural stones, single-fired tiles and stoneware with a medium-high degree of dirt

SPEEDY RAPIDO coloured microfiber mop, polyester backing, looped yarn, with external 2-hole flaps

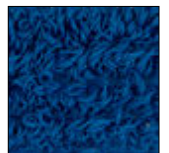

REF.	NOTES	SIZE (cm) ↓ ↓ ↓
8516A	for 40 x 11 cm mop holders	40x13
8516B	for 40 x 11 cm mop holders	40x13
8516C	for 40 x 11 cm mop holders	40x13
8516F	for 40 x 11 cm mop holders	40x13

Ideal for industrial floors, natural stones, single-fired tiles and stoneware with a medium-high degree of dirt



MOP SYSTEM

TAB SYSTEM

POCKET SYSTEM

POCKET-TAB SYSTEM

STRAP TAPE SYSTEM

GLOBO SYSTEM

DUO FACE SYSTEM

DOSING HANDLES

FLOOR CLEANING

SPEEDY TRIPLO microfibre mop, polyester backing, looped yarn, with external 2-hole flaps



REF.	NOTES	SIZE (cm) ↓ ↓ ↓
0000122D	for 40 x 11 cm mop holders	40x13
0000612D	for mop holders 50 x 13 cm	50x16

Ideal for any surface with medium-high dirt - Mops with colored borders available on request - Kindly contact our offices for the minimum order quantity

SPEEDY TRIPLO mop made of microfibre, cotton and polyester, with polyester backing, looped yarn, external 2-hole flaps

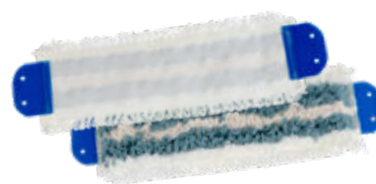

REF.	NOTES	SIZE (cm) ↓ ↓ ↓
0000FS0122D	for 40 x 11 cm mop holders	40x13

Ideal for any surface with medium-high dirt

SPEEDY MASTER-TUFT cotton mop, polyester backing, tufting, looped yarn, with flaps 2 holes



REF.	NOTES	SIZE (cm) ↓ ↓ ↓
00TM0401C00	for 40 x 11 cm mop holders	40x13
00TM0501C00	for mop holders 50 x 13 cm	50x16

Closed-ring Tufting system - Ideal for any type of surface with a medium degree of dirt and for frequent cleaning.

SPEEDY DREI-TUFT microfibre, cotton and polyester mop, polyester backing, tufting, looped yarn, with flaps 2 holes, with colour-coded tag



REF.	NOTES	SIZE (cm) ↓ ↓ ↓
00TM0414C00	for 40 x 11 cm mop holders	40x13
00TM0514C00	for mop holders 50 x 13 cm	50x16

Closed-ring Tufting system - Ideal for any type of surface with a high degree of dirt and deep cleaning.

SPEEDY MICRO-ACTIVA ultra-microfibre mop, polyester backing, with 2-hole flaps and colour-coded tag



REF.	NOTES	SIZE (cm) ↓ ↓ ↓
000EPN07012	for 40 x 11 cm mop holders	40x13
000EPN07032	for mop holders 50 x 13 cm	50x16

Ideal for industrial floors, single-fired tiles, stoneware and woods with a medium degree of dirt

SPEEDY PULI-SCRUB ultra-microfibre and polypropylene mop, polyester backing, with 2-hole flaps and colour-coded tag

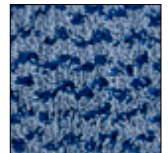

REF.	NOTES	SIZE (cm) ↓ ↓ ↓
000EPN07011	for 40 x 11 cm mop holders	40x13

Ideal for scrubbing and wet mopping of non-slip floors and natural terracotta with medium degree of stubborn dirt



MOP SYSTEM

TAB SYSTEM

POCKET SYSTEM

POCKET-TAB SYSTEM

STRAP TAPE SYSTEM

GLOBO SYSTEM

DUO FACE SYSTEM

DOSING HANDLES

SPEEDY PULI-BRUSH ultra-microfiber and polypropylene mop, polyester backing, with 2-hole flaps and colour-coded tag

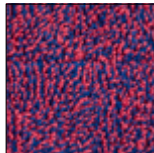
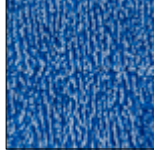

REF.	NOTES	SIZE (cm) ↓ ↓ ↓
0EPN0418C00A	for 40 x 11 cm mop holders	40x13
0EPN0418C00B	for 40 x 11 cm mop holders	40x13

Ideal for scrubbing and washing non-slip surfaces and natural terracotta with a high degree of dirt, characterized by stubborn dirt

SPEEDY SKILL-FUR striped microfiber mop, polyester backing, 2-hole flaps and colour-coded tags



REF.	NOTES	SIZE (cm) ↓ ↓ ↓
00PN0413C00		40x13
00PN0413C00E		40x13

Ideal for industrial surfaces, single-fired tiles and stoneware with a low degree of dirt

Code 00PN0413C00E available while supplies last

Click mop holder

SPEEDY ACTIVE-FUR microfiber mop with nylon inserts, polyester backing, 2-hole flaps and colour-coded tags



REF.	NOTES	SIZE (cm) ↓ ↓ ↓
00PN0406C00		40x13

Ideal for light scrubbing and wet mopping of industrial floors, single-fired tiles, stoneware and wooden floors with medium degree of dirt

CLICK - mop holder with buttons and joint



REF.	NOTES	SIZE (cm) ↓ ↓ ↓
5544		44x11

Mops for Click mop holder

Polyester and cotton mop, polyester backing, looped yarn, with flaps fitting Click mop holder



REF.	NOTES	SIZE (cm) ↓ ↓ ↓
8512		44

Ideal for any surface with medium dirt

Cotton mop, polyester backing, looped yarn, with flaps fitting Click mop holder



REF.	NOTES	SIZE (cm) ↓ ↓ ↓
0C08512		44

Ideal for any surface with medium dirt



MOP SYSTEM

TAB SYSTEM

POCKET SYSTEM

POCKET-TAB SYSTEM

STRAP TAPE SYSTEM

GLOBO SYSTEM

DUO FACE SYSTEM

DOSING HANDLES

As regards the **disinfection with pocket mop system**, Filmop proposes a range of plastic foldable mop holders, including **Click Safe** mop holder.

With Click Safe, combined with the special bucket with cover, there is no need to touch the mop used to release it, therefore preventing hands from turning into vehicles for bacteria and viruses.

The used mop is collected directly into the bag, so the operator does not have to continually bend over to pick it up from the floor.

Click Safe also allows the mop to be attached to the mop holder without effort or hand contact, preventing cross-contamination.

The mop holder is designed to be used with the full range of 40 cm mops with pockets and the Mono-Tex disposable mop, which is ideal for maintaining a high standard of hygiene.



All Filmop mop holders can be equipped with **Lock System** joint

PATENTED SYSTEM



HOW TO USE IT



HOW TO REMOVE THE MOP



Fix the mop to the mop holder.



Start mopping the floor.



Insert the mop holder into the bucket with cover.



Pull up the mop holder to release the mop.

Mop holders for pocket mop

CLICK SAFE - plastic foldable mop holder



REF.	NOTES	SIZE (cm)
0000TP0012AU		40x11

CLICK SAFE - plastic foldable mop holder with ErgoSwing fitting



REF.	NOTES	SIZE (cm)
0000TP0912AU		40x11

Use with ErgoSwing system handle, code 0000AM3045
Learn more about ErgoSwing in the handle section



MOP SYSTEM

TAB SYSTEM

POCKET SYSTEM

POCKET-TAB SYSTEM

STRAP TAPE SYSTEM

GLOBO SYSTEM

DUO FACE SYSTEM

DOSING HANDLES

CLICK SAFE - plastic foldable mop holder with Lock System fitting

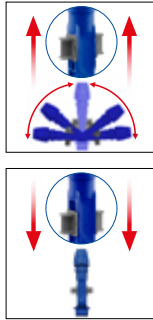

REF.	NOTES	SIZE (cm)
0000TP0312AU		40x11

CLICK SAFE - plastic foldable mop holder with Uni-Connect fitting and cone and Lock System

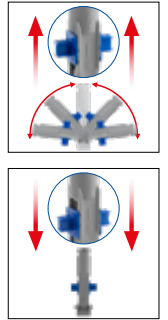

REF.	NOTES	SIZE (cm)
0000TP1812AU		40x11

Learn more about Uni-Connect in the glass and surfaces section

UNIKO - foldable plastic mop holder with mop fixing clip



REF.	NOTES	SIZE (cm)
0000TD0020AU		40x11
0000TD0010AU		50x13

UNIKO - plastic folding mop holder with mop head hook and ErgoSwing joint



REF.	NOTES	SIZE (cm)
0000TD0920AU		40x11

Use with ErgoSwing system handle, code 0000AM3045
Learn more about ErgoSwing in the handle section

UNIKO - foldable plastic mop holder with mop fixing clip and Lock System

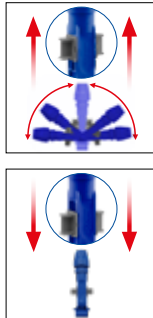

REF.	NOTES	SIZE (cm)
0000TD0320AU		40x11

UNIKO - foldable plastic mop holder with mop fixing clip, Uni-Connect fitting and cone and Lock System

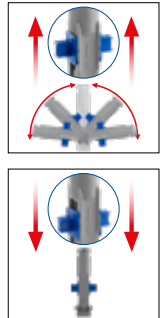

REF.	NOTES	SIZE (cm)
0000TD1820AU		40x11

Learn more about Uni-Connect in the glass and surfaces section

Foldable plastic mop holder



REF.	NOTES	SIZE (cm)
8115U	completely grey	42x9
8132AU		40x11
8130AU		50x13



MOP SYSTEM

TAB SYSTEM

POCKET SYSTEM

POCKET-TAB SYSTEM

STRAP TAPE SYSTEM

GLOBO SYSTEM

DUO FACE SYSTEM

DOSING HANDLES

Pocket mops

Polyester and cotton pocket mop, polyester backing, looped yarn



REF.	NOTES	SIZE (cm) ↓ ↓ ↓
0000FD2401D	for 40 x 11 cm mop holders	40x13
8422	for mop holder 40x13 cm	40x16
8423	for mop holders 50 x 13 cm	50x16

Ideal for any surface with medium dirt - Mops with colored borders available on request - Contact our offices for minimum quantity

Polyester and cotton pocket mop, polyester backing, looped yarn inside and cut yarn outside



REF.	NOTES	SIZE (cm) ↓ ↓ ↓
0000FD2402D	for 40 x 11 cm mop holders	40x13
8422/M	for mop holder 40x13 cm	40x16
8423/M	for mop holders 50 x 13 cm	50x16

Ideal for any surface with medium dirt - Mops with colored borders available on request - Contact our offices for minimum quantity

Cotton pocket mop, polyester backing, looped yarn



REF.	NOTES	SIZE (cm) ↓ ↓ ↓
0000FD1401D	for 40 x 11 cm mop holders	40x13
0000FD0501D	for mop holders 50 x 13 cm	50x16

Ideal for any surface with medium dirt - Mops with colored borders available on request - Contact our offices for minimum quantity

Cotton pocket mop, polyester backing, looped yarn inside and cut yarn outside



REF.	NOTES	SIZE (cm) ↓ ↓ ↓
0000FD1402D	for 40 x 11 cm mop holders	40x13
0000FD0502D	for mop holders 50 x 13 cm	50x16

Ideal for any surface with medium dirt - Mops with colored borders available on request - Contact our offices for minimum quantity

RAPIDO - microfiber mop, polyester backing, looped yarn, with pockets



REF.	NOTES	SIZE (cm) ↓ ↓ ↓
0000311D	for 40 x 11 cm mop holders	40x13
0000511D	for mop holders 50 x 13 cm	50x16

Ideal for industrial floors, natural stones, single-fired tiles and stoneware with a medium-high degree of dirt

TRIPLO - microfiber, cotton and polyester mop, polyester backing, looped yarn, with pockets



REF.	NOTES	SIZE (cm) ↓ ↓ ↓
0000312D	for 40 x 11 cm mop holders	40x13
0000512D	for mop holders 50 x 13 cm	50x16

Ideal for any surface with medium-high dirt - Mops with colored borders available on request - Kindly contact our offices for the minimum order quantity



MOP SYSTEM

TAB SYSTEM

POCKET SYSTEM

POCKET-TAB SYSTEM

STRAP TAPE SYSTEM

GLOBO SYSTEM

DUO FACE SYSTEM

DOSING HANDLES

RAPIDO - colored microfiber mop, polyester backing, looped yarn, with pockets



REF.	NOTES	SIZE (cm)
0000311AA	for 40 x 11 cm mop holders	40x13
0000311BB	for 40 x 11 cm mop holders	40x13
0000311CC	for 40 x 11 cm mop holders	40x13
0000311FF	for 40 x 11 cm mop holders	40x13

Ideal for industrial floors, natural stones, single-fired tiles and stoneware with a medium-high degree of dirt

MASTER-TUFT - cotton pocket mop, polyester backing, tufting, cut outside



REF.	NOTES	SIZE (cm)
00TM0401B00	for 40 x 11 cm mop holders	40x13
00TM0501B00	for mop holders 50 x 13 cm	50x16

Closed-ring Tufting system - Ideal for any type of surface with a medium degree of dirt and for frequent cleaning.

DREI-TUFT - microfibre, cotton and polyester mop head, polyester backing, tufting, external cut wire, with pockets and colour-coded tag

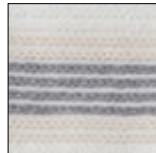
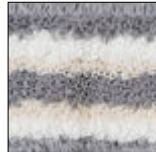

REF.	NOTES	SIZE (cm)
00TM0414B00	for 40 x 11 cm mop holders	40x13
00TM0514B00	for mop holders 50 x 13 cm	50x16

Closed-ring Tufting system - Ideal for any type of surface with a high degree of dirt and deep cleaning.

MICRO-ACTIVA - ultra-microfiber pocket mop, polyester backing, with colour-coded tag



REF.	NOTES	SIZE (cm)
000EPN04012	for 40 x 11 cm mop holders	40x13
000EPN06012	for mop holders 50 x 13 cm	50x16

Ideal for industrial floors, single-fired tiles, stoneware and woods with a medium degree of dirt

PULI-SCRUB ultra-microfiber and polypropylene pocket mop, polyester backing, with colour-coded tags

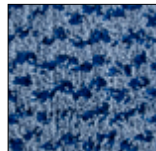

REF.	NOTES	SIZE (cm)
000EPN04011	for 40 x 11 cm mop holders	40x13

Ideal for scrubbing and wet mopping of non-slip floors and natural terracotta with medium degree of stubborn dirt

PULI-BRUSH - ultra-microfiber and polypropylene pocket mop, polyester backing, with colour-coded tags

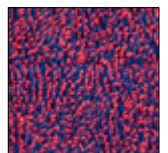
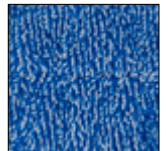

REF.	NOTES	SIZE (cm)
0EPN0418B00A	for 40 x 11 cm mop holders	40x13
0EPN0418B00B	for 40 x 11 cm mop holders	40x13

Ideal for scrubbing and washing non-slip surfaces and natural terracotta with a high degree of dirt, characterized by stubborn dirt



MOP SYSTEM

TAB SYSTEM

POCKET SYSTEM

POCKET-TAB SYSTEM

STRAP TAPE SYSTEM

GLOBO SYSTEM

DUO FACE SYSTEM

DOSING HANDLES

ACTIVE-FUR - microfiber pocket mop with nylon inserts, polyester backing and colour-coded tags



REF.	NOTES	SIZE (cm) ↓ ↓ ↓
00PN0406B00	for 40 x 11 cm mop holders	40x13
00PN0506B00	for mop holders 50 x 13 cm	50x16

Ideal for light scrubbing and wet mopping of industrial floors, single-fired tiles, stoneware and wooden floors with medium degree of dirt

SKILL-FUR - striped microfiber pocket mop with polyester backing and colour-coded tags

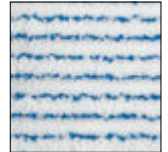

REF.	NOTES	SIZE (cm) ↓ ↓ ↓
00PN0413B00	for 40 x 11 cm mop holders	40x13
00PN0413B00E	for 40 x 11 cm mop holders	40x13
00PN0513B00	for mop holders 50 x 13 cm	50x16
00PN0513B00E	for mop holders 50 x 13 cm	50x16

Ideal for industrial surfaces, single-fired tiles and stoneware with a low degree of dirt

Code 00PN0413B00E and code 00PN0513B00E available while supplies last

MONO-TEX - microfiber disposable pocket mop



REF.	NOTES	SIZE (cm) ↓ ↓ ↓
0000PN03140	pck.: 12 bags with 35 pcs	40

Ideal for hospital interior surfaces with a low degree of dirt. - Semi-disposable: can be washed and reused up to 10 times

Frames for flaps/pockets mops

Foldable plastic mop holder with pockets and flaps



REF.	NOTES	SIZE (cm) ↓ ↓ ↓
0000TP0004AU		40x11
0000TP0005AU		50x13

Foldable plastic mop holder for mops with pockets and flaps, with Uni-Connect fitting and cone and Lock System

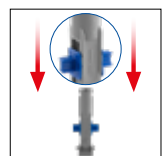
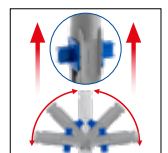

REF.	NOTES	SIZE (cm) ↓ ↓ ↓
0000TP1804AU		40x11

Learn more about Uni-Connect in the glass and surfaces section



MOP SYSTEM

TAB SYSTEM

POCKET SYSTEM

POCKET-TAB SYSTEM

STRAP TAPE SYSTEM

GLOBO SYSTEM

DUO FACE SYSTEM

DOSING HANDLES

FLOOR CLEANING

Pocket mops with flaps

Cotton mop with pockets and flaps, polyester backing, looped yarn inside and cut yarn outside



REF.	NOTES	SIZE (cm) ↓ ↓ ↓
00FM0401D00		40x13
00FM0501D00		50x16

Ideal for any surface with medium dirt

RAPIDO - microfiber mop, polyester backing, looped yarn, with pockets and flaps



REF.	NOTES	SIZE (cm) ↓ ↓ ↓
00FC0402D00		40x13

Ideal for industrial floors, natural stones, single-fired tiles and stoneware with a medium-high degree of dirt

MASTER-TUFT - cotton mop, polyester backing, tufting, cut outside, with pockets and flaps



REF.	NOTES	SIZE (cm) ↓ ↓ ↓
00TM0401D00		40x13
00TM0501D00		50x16

Closed-ring Tufting system - Ideal for any type of surface with a medium degree of dirt and for frequent cleaning.

DREI-TUFT - microfiber, cotton and polyester mop, polyester backing, tufting, cut outside, with pockets and flaps, colour-coded tag



REF.	NOTES	SIZE (cm) ↓ ↓ ↓
00TM0414D00		40x13
00TM0514D00		50x16

Closed-ring Tufting system - Ideal for any type of surface with a high degree of dirt and deep cleaning.

ACTIVE-FUR - microfiber mop with nylon inserts, polyester backing, pockets and flaps, colour-coded tags

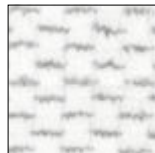

REF.	NOTES	SIZE (cm) ↓ ↓ ↓
00PN0406D00		40x13
00PN0506D00		50x16

Ideal for light scrubbing and wet mopping of industrial floors, single-fired tiles, stoneware and wooden floors with medium degree of dirt

SKILL-FUR - striped microfiber mop, polyester backing, pockets and flaps, with colour-coded tags

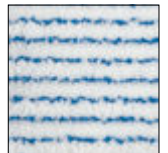

REF.	NOTES	SIZE (cm) ↓ ↓ ↓
00PN0413D00		40x13
00PN0413D00E		40x13
00PN0513D00		50x16
00PN0513D00E		50x16

Ideal for industrial surfaces, single-fired tiles and stoneware with a low degree of dirt

Code 00PN0413D00E and code 00PN0513D00E available while supplies last



MOP SYSTEM

TAB SYSTEM

POCKET SYSTEM

POCKET-TAB SYSTEM

STRAP TAPE SYSTEM

GLOBO SYSTEM

DUO FACE SYSTEM

DOSING HANDLES

FLOOR CLEANING

Disinfection with strap tape system can be used with all mops with backing with strap tape system, combined with the specific plastic or aluminum mop holder.

Lightweight and resistant, the mop holders feature a trapezoidal shape that makes it easy to clean even hard-to-reach areas and flat edges that ensure excellent adherence to the floor.

The strap tape system offers important advantages: optimal cleaning of floors, walls, and baseboards, less strain, and cost savings due to the possibility of changing profiles without the need to replace the entire tool.



All Filmop mop holders can be equipped with **Lock System** joint



HOW TO USE IT



Fix the mop to the mop holder directly into the TOP-DOWN® bucket.



Start mopping and disinfecting the floor.

HOW TO REMOVE THE MOP



Hold mop ends with both feet and pull up the mop holder to remove the mop.



Drop the mop into the provided collection bag.



Unlocked joint: floor mopping



Locked joint: cleaning of walls and ceilings



Mop holders with strap tape system

Mop holder with strips 2,5 cm for strap tape system



REF.	NOTES	SIZE (cm) ↓ ↓ ↓
5263A		30
5259A		40
5260A		60

Mop holder with strips 2,5 cm for strap tape system and with Lock System joint

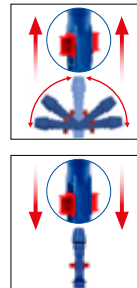

REF.	NOTES	SIZE (cm) ↓ ↓ ↓
5359A		40
5360A		60

Tool for 2.5 cm wide strap tape system profile mops with ErgoSwing joint



REF.	NOTES	SIZE (cm) ↓ ↓ ↓
5959A		40
5960A		60

Use with ErgoSwing system handle, code 0000AM3045
Learn more about ErgoSwing in the handle section



MOP SYSTEM

TAB SYSTEM

POCKET SYSTEM

POCKET-TAB SYSTEM

STRAP TAPE SYSTEM

GLOBO SYSTEM

DUO FACE SYSTEM

DOSING HANDLES

Mop holder with 2,5 cm strips for strap tape system, with Uni-Connect fitting and cone and Lock System

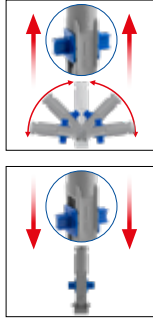

REF.	NOTES	SIZE (cm) ↓ ↓ ↓
0000TP1815A		40
0000TP1816A		60

Learn more about Uni-Connect in the glass and surfaces section

Mop holder with strips 1,5 cm for strap tape system



REF.	NOTES	SIZE (cm) ↓ ↓ ↓
5278A		80
5279A		100

Aluminium mop holder with strap tape system strips



REF.	NOTES	SIZE (cm) ↓ ↓ ↓
0000TA0030A		30
0000TA0040A		40
0000TA0060A		60

Aluminium mop holder with strips for strap tape system and Lock System joint

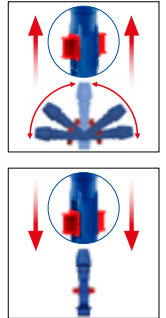
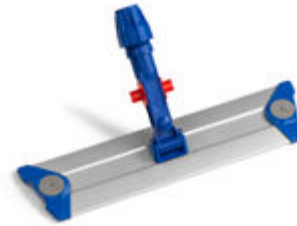

REF.	NOTES	SIZE (cm) ↓ ↓ ↓
0000TA0340A		40
0000TA0360A		60

Aluminium mop holder with strips for strap tape system, with ErgoSwing joint



REF.	NOTES	SIZE (cm) ↓ ↓ ↓
0000TA0940A		40
0000TA0960A		60

Use with ErgoSwing system handle, code 0000AM3045
Learn more about ErgoSwing in the handle section

Aluminium mop holder with strips for strap tape system, with Uni-Connect fitting and cone and Lock System

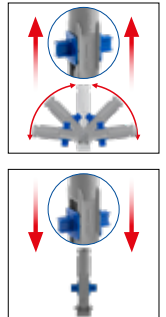
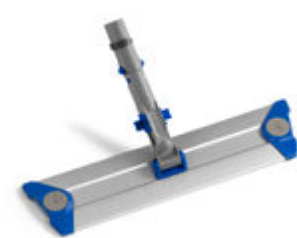

REF.	NOTES	SIZE (cm) ↓ ↓ ↓
0000TA1840A		40
0000TA1860A		60

Learn more about Uni-Connect in the glass and surfaces section



MOP SYSTEM

TAB SYSTEM

POCKET SYSTEM

POCKET-TAB SYSTEM

STRAP TAPE SYSTEM

GLOBO SYSTEM

DUO FACE SYSTEM

DOSING HANDLES

Components for tools with strap tape system

Plastic joint with articulation



REF.	NOTES
4008A	

Lock System plastic joint



REF.	NOTES
4028AB	

Round cloth star fixing clip



REF.	NOTES
60062U	

Spare strip for strap tape system plastic mop holders



REF.	NOTES
P191085U	for mop holder 30 cm long side (23,3 cm)
P191077U	for mop holder 30 cm short side (20 cm)
P191068U	for mop holder 40 cm long side (35,4 cm)
P191069U	for mop holder 40 cm short side (32 cm)
P191071U	for mop holder 60 cm long side (52,2 cm)
P191070U	for mop holder 60 cm short side (48,6 cm)

Spare strip for strap tape system aluminium mop holders

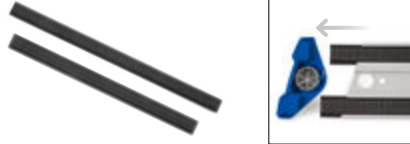

REF.	NOTES
P191105H	for mop holder 30 cm long side (23.2 cm)
P191104H	for mop holder 30 cm short side (21 cm)
P191107H	for mop holder 40 cm long side (33,1 cm)
P191106H	for mop holder 40 cm short side (31 cm)
P191109H	for mop holder 60 cm long side (52,2 cm)
P191108H	for mop holder 60 cm short side (50,6 cm)

Mops for strap tape system

Polyester and cotton mop, cut yarn, with backing for strap tape system



REF.	NOTES	SIZE (cm)
5803		40x10
5807		60x10

Ideal for any surface with medium dirt

Cotton mop, looped yarn, with backing for strap tape system



REF.	NOTES	SIZE (cm)
0000204A		40x10
0000205A		60x10

Ideal for any surface with medium dirt

TRIPLO - microfiber, cotton and polyester mop, looped yarn, with backing for strap tape system



REF.	NOTES	SIZE (cm)
0000264A		40x10
0000265A		60x10

Ideal for any surface with medium-high dirt

TWIST TUFT - microfiber string twine mop, polyester backing, tufting, looped yarn, with strap tape system, colour-coded tag



REF.	NOTES	SIZE (cm)
OETC0419A00DD		40x13

Ideal for all types of floors, both continuous flooring and tiled floors with grouts, with a medium-high degree of dirt



MOP SYSTEM

TAB SYSTEM

POCKET SYSTEM

POCKET-TAB SYSTEM

STRAP TAPE SYSTEM

GLOBO SYSTEM

DUO FACE SYSTEM

DOSING HANDLES

RAPIDO SUPER EXTRA - high-performing white microfiber mop, looped yarn, with colored backing for strap tape system



REF.	NOTES	SIZE (cm)
		↓ ↓ ↓
00PN0323A00DA		30x10
00PN0423A00DA		40x10
00PN0423A00DB		40x10
00PN0423A00DC		40x10
00PN0423A00DF		40x10
00PN0623A00DA		60x10

Ideal for industrial floors, natural stones, single-fired tiles and stoneware with a medium-high degree of dirt

RAPIDO SUPER EXTRA - high-performing white microfiber mop for big areas, with backing for strap tape system



REF.	NOTES	SIZE (cm)
		↓ ↓ ↓
00PN0823A00DA	for mop holder art. 5201/28 and art. 5278	80x10
00PN1023A00DA	for mop holder art. 5201/21 and art. 5278	100x10

Ideal for industrial floors, natural stones, single-fired tiles and stoneware with a medium-high degree of dirt

RAPIDO SUPER - high-performing white microfiber mop, looped yarn, with colored backing for strap tape system



REF.	NOTES	SIZE (cm)
		↓ ↓ ↓
00PN0309A00DA		30x10
00PN0309A00DB		30x10
00PN0309A00DC		30x10
00PN0309A00DF		30x10
00PN0409A00DA		40x10
00PN0409A00DB		40x10
00PN0409A00DC		40x10
00PN0409A00DF		40x10
00PN0609A00DA		60x10
00PN0609A00DB		60x10
00PN0609A00DC		60x10
00PN0609A00DF		60x10

Ideal for any surface with medium-high dirt

RAPIDO - colored microfiber mop, looped yarn, with colored backing for strap tape system

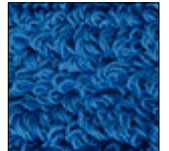

REF.	NOTES	SIZE (cm)
		↓ ↓ ↓
0000214AA		40x10
0000214BB		40x10
0000214CC		40x10
0000214FF		40x10

Ideal for industrial floors, natural stones, single-fired tiles and stoneware with a medium-high degree of dirt



MOP SYSTEM

TAB SYSTEM

POCKET SYSTEM

POCKET-TAB SYSTEM

STRAP TAPE SYSTEM

GLOBO SYSTEM

DUO FACE SYSTEM

DOSING HANDLES

DUETTO - microfibre mop with strap tape system and color-coded label

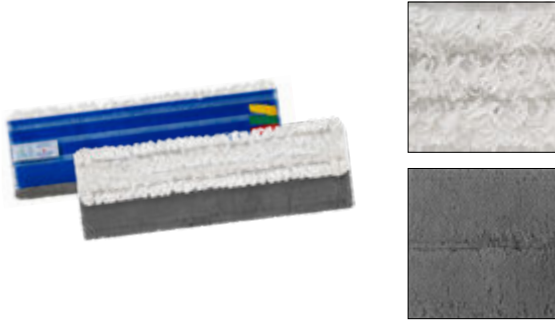

REF.	NOTES	SIZE (cm) ↓ ↓ ↓
0EPN0426A00		40

Ideal to dust and wash industrial floors/surfaces, natural stones, single-fired tiles, stoneware with medium-high degree of dirt

MICRO-ACTIVA - ultra-microfiber mop, polyester backing, with strap tape system and colour-coded tag



REF.	NOTES	SIZE (cm) ↓ ↓ ↓
000EPN02012		30
000EPN03012		40
000EPN03022		60

Ideal for industrial floors, single-fired tiles, stoneware and woods with a medium degree of dirt

PULI-SCRUB - ultra-microfiber and polypropylene mop with strap tape system and colour-coded tag



REF.	NOTES	SIZE (cm) ↓ ↓ ↓
000EPN02011		30
000EPN03011		40
000EPN03021		60

Ideal for scrubbing and wet mopping of non-slip floors and natural terracotta with medium degree of stubborn dirt

PULI-SCRUB PLUS - Ultra-Microfibre and Polypropylene mop with strap tape system and colour-coded tags, high absorbency



REF.	NOTES	SIZE (cm) ↓ ↓ ↓
0EPN0425A00E	suitable for mop holder 40x11 cm	40x13

Ideal to scrub and wash non-slip floors and natural fired brick with medium-high degree of dirt

PULI-BRUSH - ultra-microfiber and polypropylene mop, polyester backing, strap tape system and colour-coded tag

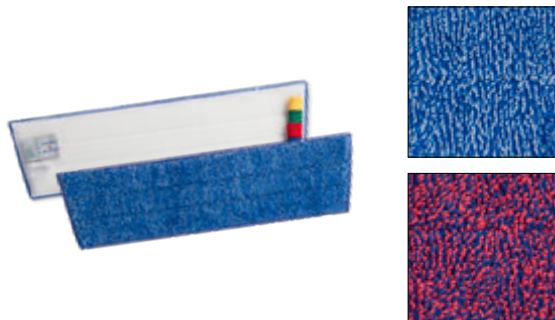

REF.	NOTES	SIZE (cm) ↓ ↓ ↓
0EPN0418A00A		40
0EPN0418A00B		40

Ideal for scrubbing and washing non-slip surfaces and natural terracotta with a high degree of dirt, characterized by stubborn dirt

SMART-FUR - bordered microfibre mop with backing for strap tape system and colour-coded tags

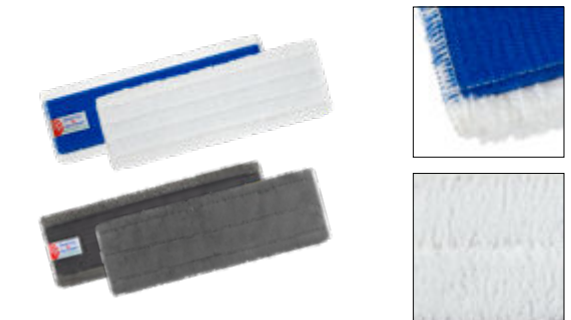

REF.	NOTES	SIZE (cm) ↓ ↓ ↓
00PN0403H00		40
00PN0403H00E		40
00PN0603H00		60
00PN0603H00E		60
00PN0803H00		80
00PN0803H00E		80
00PN1003H00		100
00PN1003H00E		100

Ideal for any kind of surface with medium degree of dirt - The shock-absorbing border guarantees a better protection for and against baseboards and walls

Code 00PN0803H00 available while supplies last



MOP SYSTEM

TAB SYSTEM

POCKET SYSTEM

POCKET-TAB SYSTEM

STRAP TAPE SYSTEM

GLOBO SYSTEM

DUO FACE SYSTEM

DOSING HANDLES

Rubber brush with plastic grip



ACTIVE-FUR - bordered microfiber mop with nylon inserts, backing for strap tape system and colour-coded tags

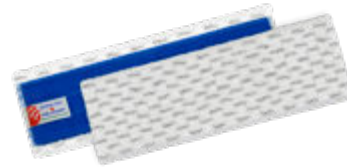

REF.	NOTES	SIZE (cm) ↓ ↓ ↓
8112		16x5,3x9

Ideal for the maintenance of Smart-Fur mops

REF.	NOTES	SIZE (cm) ↓ ↓ ↓
00PN0406H00		40
00PN0606H00		60

Ideal for light scrubbing and washing of industrial, single-fired floors, stoneware and wood floors with a medium degree of dirt. The shock-absorbing border guarantees a better protection for and against baseboards and walls.

SKILL-FUR - striped bordered microfiber mop, backing for strap tape system and colour-coded tags

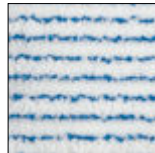

REF.	NOTES	SIZE (cm) ↓ ↓ ↓
00PN0413H00		40
00PN0413H00E		40
00PN0613H00		60
00PN0613H00E		60

Ideal for industrial floors, single-fired tiles and stoneware with low degree of dirt - The shock-absorbing border guarantees a better protection for and against baseboards and walls

Code 00PN0413H00E and code 00PN0613H00E available while supplies last

MONO-TEX - microfiber disposable mop, for strap tape system



REF.	NOTES	SIZE (cm) ↓ ↓ ↓
0000PN02040	pck.: 10 polybags with 50 pcs each	42x14

Ideal for hospital interior surfaces with a low degree of dirt. - Semi-disposable: can be washed and reused up to 10 times

MONO-TNT - TNT disposable mop, for strap tape system



REF.	NOTES	SIZE (cm) ↓ ↓ ↓
00PU0415A00	Pck: 10 polybags with 25 pcs each	40

Ideal for hospital interior surfaces with a low degree of dirt.

Pad for strap tape system mop holders



REF.	NOTES	SIZE (cm) ↓ ↓ ↓
8134		42x9,5

Fitting mop holders with strap tape system and disposable cloths



MOP SYSTEM

TAB SYSTEM

POCKET SYSTEM

POCKET-TAB SYSTEM

STRAP TAPE SYSTEM

GLOBO SYSTEM

DUO FACE SYSTEM

DOSING HANDLES

FLOOR CLEANING

Mop holders with Microplast strips

Mop holder with strips **MICROPLAST**, with Lock System

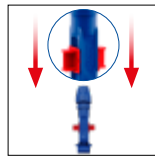
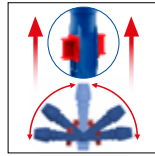

REF.	NOTES	SIZE (cm) ↓ ↓ ↓
5364A		40

Mop holder with **MICROPLAST** strips, with Uni-Connect fitting and cone and Lock System

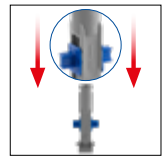
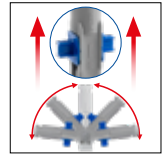

REF.	NOTES	SIZE (cm) ↓ ↓ ↓
0000TP1814A		40

Learn more about Uni-Connect in the glass and surfaces section

Mop holder with **MICROPLAST** strips



REF.	NOTES	SIZE (cm) ↓ ↓ ↓
5264A		40

MONO-TEX - microfiber disposable mop, for strap tape system



REF.	NOTES	SIZE (cm) ↓ ↓ ↓
0000PN02040	pck.: 10 polybags with 50 pcs each	42x14

Ideal for hospital interior surfaces with a low degree of dirt. - Semi-disposable: can be washed and reused up to 10 times

MONO-TNT - TNT disposable mop, for strap tape system



REF.	NOTES	SIZE (cm) ↓ ↓ ↓
00PU0415A00	Pck: 10 polybags with 25 pcs each	40

Ideal for hospital interior surfaces with a low degree of dirt.

Pad for strap tape system mop holders



REF.	NOTES	SIZE (cm) ↓ ↓ ↓
8134		42x9,5

Fitting mop holders with strap tape system and disposable cloths

Components for tools with Microplast

Plastic joint with articulation



REF.	NOTES
4008A	

Lock System plastic joint



REF.	NOTES
4028AB	

Strip for mop holder **MICROPLAST**



REF.	NOTES
P291050H	short side (31,7 cm)
P291051H	long side (35,3 cm)



Boundless cleaning all-in-one

Filmop has developed a cleaning system that goes beyond the geographic boundaries and habits in the cleaning world: **Globo** is the first and only **universal wet mopping system** that can be used as any traditional system, obtaining superior results in terms of performance, hygiene and ergonomics.

It adapts to the needs of operators who can continue to work using their preferred method (strap tape system, pockets, pockets-flaps) with the advantage to work with a single **more ergonomic, hygienic and practical** system.

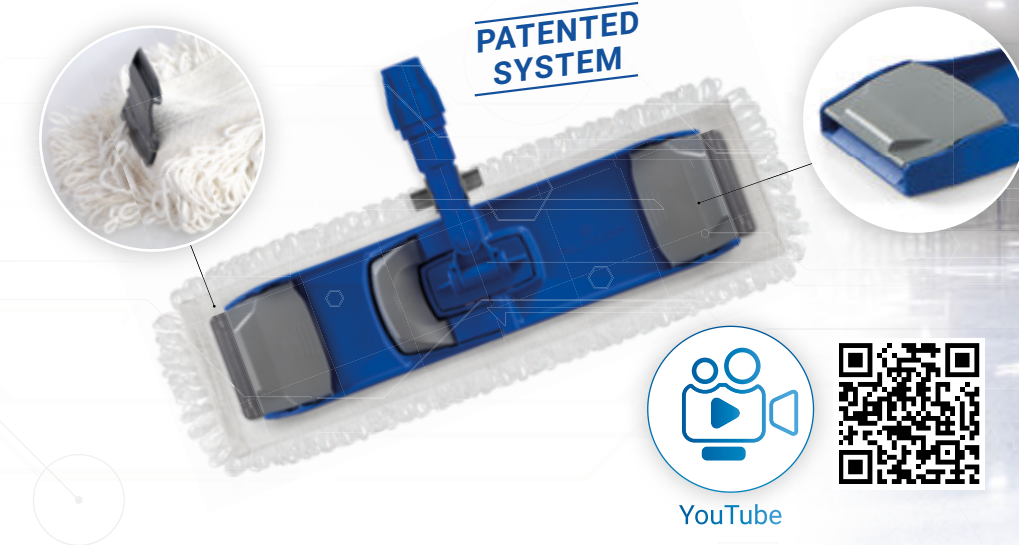

Globo system, composed of one **foldable mop holder** and one **mop with micro flaps**, has been designed to **make cleaning operations easier assuring the highest hygiene**:

- **It makes the mop fixing and release operations quicker and easier**, obtaining a cleaning process optimization, a considerable working time reduction and less efforts in comparison with traditional cleaning systems.
- **100% touch-free system: touchless** fixing and release of the mop from the mop holder, thus **reducing the cross contamination risk**.
- **It prevents fatigue**: the operator always works in conditions of maximum ergonomics; this system allows indeed to avoid continuous bending and a wrong posture during the cleaning operations.
- It can be used with any wet mopping system: **soaking on demand, pre-soaking or traditional wringing system**, ensuring high performances.

Strap tape system
Pocket system



Pocket-tab system



Tab system





MOP SYSTEM

TAB SYSTEM

POCKET SYSTEM

POCKET-TAB SYSTEM

STRAP TAPE SYSTEM

GLOBO SYSTEM

DUO FACE SYSTEM

DOSING HANDLES

Globo mop holders

GLOBO mop holder- foldable plastic mop holder



REF.	NOTES	SIZE (cm) ↓ ↓ ↓
0000TP0009AU		40x11

GLOBO mop holder- foldable plastic mop holder with Lock System joint

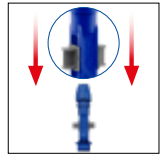
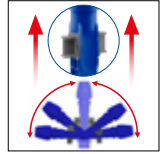

REF.	NOTES	SIZE (cm) ↓ ↓ ↓
0000TP0309AU		40x11

GLOBO mop holder- foldable plastic mop holder with ErgoSwing joint



REF.	NOTES	SIZE (cm) ↓ ↓ ↓
0000TP0909AU		40x11

GLOBO mop holder - foldable plastic mop holder with Uni-Connect fitting and cone and Lock System

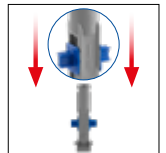
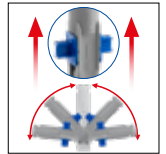

REF.	NOTES	SIZE (cm) ↓ ↓ ↓
0000TP1809AU		40x11

Use with ErgoSwing system handle, code 0000AM3045
Learn more about ErgoSwing in the handle section



MOP SYSTEM

TAB SYSTEM

POCKET SYSTEM

POCKET-TAB SYSTEM

STRAP TAPE SYSTEM

GLOBO SYSTEM

DUO FACE SYSTEM

DOSING HANDLES

Globo mops

GLOBO COTTON cotton mop with polyester backing, looped yarn inside, cut yarn outside, with micro flaps



REF.	NOTES	SIZE (cm) ↓ ↓ ↓
00FM0401K01		40x13

Ideal for any surface with medium dirt

GLOBO POLY-COTTON polyester and cotton mop, polyester backing, looped yarn inside and cut yarn outside, with micro flaps



REF.	NOTES	SIZE (cm) ↓ ↓ ↓
00FM0410K01		40x13

Ideal for any surface with medium dirt

GLOBO TRIPLO mop, microfibre, cotton and polyester, polyester backing, looped yarn, with micro flaps and colour-coded tags



REF.	NOTES	SIZE (cm) ↓ ↓ ↓
00FC0417K00		40x13

Ideal for any surface with medium-high dirt

Available while stocks last

GLOBO TRIPLO mop, microfibre, cotton and polyester, polyester backing, looped yarn, with micro flaps and colour-coded tags



REF.	NOTES	SIZE (cm) ↓ ↓ ↓
00FC0417K01		40x13

Ideal for any surface with medium-high dirt

GLOBO RAPIDO microfibre mop with polyester backing, looped yarn, micro flaps and color-coded tags



REF.	NOTES	SIZE (cm) ↓ ↓ ↓
00FC0402K00		40x13

Ideal for industrial floors, natural stones, single-fired tiles and stoneware with a medium-high degree of dirt

Available while stocks last

GLOBO RAPIDO microfibre mop with polyester backing, looped yarn, micro flaps and color-coded tags



REF.	NOTES	SIZE (cm) ↓ ↓ ↓
00FC0402K01		40x13

Ideal for industrial floors, natural stones, single-fired tiles and stoneware with a medium-high degree of dirt



MOP SYSTEM

TAB SYSTEM

POCKET SYSTEM

POCKET-TAB SYSTEM

STRAP TAPE SYSTEM

GLOBO SYSTEM

DUO FACE SYSTEM

DOSING HANDLES

GLOBO MICRO-ACTIVA ultra-microfibre mop with polyester backing, micro flaps and color-coded tags

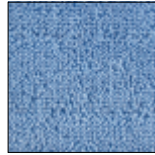

REF.	NOTES	SIZE (cm) ↓ ↓ ↓
0EPN0404K00		40x13

Ideal for industrial floors, single-fired tiles, stoneware and woods with a medium degree of dirt

GLOBO PULI-SCRUB ultra-microfibre and polypropylene mop with polyester backing, micro flaps and colour-coded tags

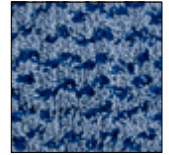

REF.	NOTES	SIZE (cm) ↓ ↓ ↓
0EPN0412K00		40x13

Ideal for scrubbing and wet mopping of non-slip floors and natural terracotta with medium degree of stubborn dirt

GLOBO PULI-BRUSH ultra-microfibre and polypropylene mop with polyester backing, micro flaps and colour-coded tags

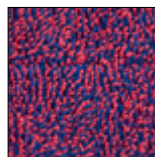
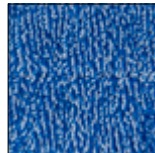

REF.	NOTES	SIZE (cm) ↓ ↓ ↓
0EPN0418K00A		40x13
0EPN0418K00B		40x13

Ideal for scrubbing and washing non-slip surfaces and natural terracotta with a high degree of dirt, characterized by stubborn dirt

GLOBO ACTIVE-FUR microfibre mop with nylon inserts, polyester backing, micro flaps and colour-coded tags



REF.	NOTES	SIZE (cm) ↓ ↓ ↓
00PN0406K00		40x13

Ideal for light scrubbing and wet mopping of industrial floors, single-fired tiles, stoneware and wooden floors with medium degree of dirt

GLOBO SKILL-FUR microfibre mop with stripes, polyester backing, micro flaps and colour-coded tags

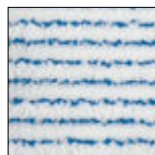

REF.	NOTES	SIZE (cm) ↓ ↓ ↓
00PN0413K00		40x13
00PN0413K00E		40x13

Ideal for industrial surfaces, single-fired tiles and stoneware with a low degree of dirt

Code 00PN0413K00E available while supplies last



Turn and double the face of clean!



Duo Face is the innovating combined system (mop holder + mops) designed by Filmop to simplify and optimize the cleaning of floors and vertical surfaces.

The **reversible mop holder** and the **range of double-faced mops** allow to **double the efficiency** of the cleaning operations with one single system.

PATENTED SYSTEM

Reversible mop holder

- Make full use of the double mop holder thanks to its two perfectly flat and reversible sides
- Fix the mop to the mop holder with 2 simple clicks: the special raised central part allows to insert the mop in the right position, its serrated external borders assure a stable and non-slip mop fixing
- Avoid any contact of the mop with your hands thanks to its foot-operated pedal devices
- Clean also the vertical surfaces very easily thanks to the Lock System technology
- Do not waste your strength: the central joint distributes the pressure uniformly onto the whole surface of the mop holder

Double-faced mops

The two mop sides are made of 100% cleaning surface and matched together thanks to a special ultrasonic welding that makes seamless Duo Face mops **much more resistant and more hygienic**, as they have no pockets or extra material where dirt and bacteria would hide and grow.

Duo Face mops are **perfectly reversible**:

- **Turn the mop and double the square meters of surface:** use the first side of the mop, turn it and go on with the second side. 1 traditional mop cleans about 25 sqm, 1 Duo Face mop: 50 sqm.
- **Turn the mop and double the possible cleaning operations:** wash, turn and dry! Duo Face BARRIER mops are made with a special **waterproof barrier** inside that separates the two cleaning sides of the mop. Dry and wet finally together in one single mop.

Duo Face ultra-microfibers

Duo Face mops are the outcome of a long and **careful planning** that has involved Filmop R&D department for a long time to reach the best final result: a wide range of double-faced mops to satisfy several and different cleaning needs, manufactured with **completely Made in Italy** and **high quality microfiber** material.

Duo Face microfibers guarantee the maximum performance concerning **collection of dirt, release of dirt** during washing, **mop running, quality** of final cleaning results, **durability and mop lifetime**.

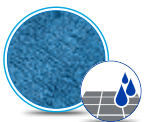

WASH BASIC:
standard wet mopping

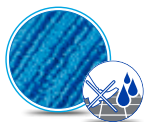

WASH SAFE E SAFE:
wet mopping non-slip floors

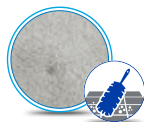

DUST:
dry dusting

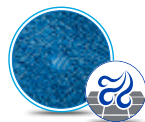

DRY:
drying

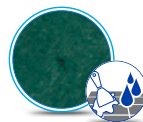

SCRUBLY:
scrubbing

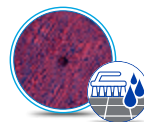

WASH BRUSH E BRUSH:
removal of stubborn dirt



MOP SYSTEM

TAB SYSTEM

POCKET SYSTEM

POCKET-TAB SYSTEM

STRAP TAPE SYSTEM

GLOBO SYSTEM

DUO FACE SYSTEM

DOSING HANDLES

Duo Face mop holders

DUO FACE - reversible plastic mop holder with Lock System



REF.	NOTES	SIZE (cm) ↓ ↓ ↓
0000TP0303U		40x10,5

Duo Face mops

DUO FACE WASH BASIC - ultra-microfibre double-faced mop, floor wet mopping



REF.	NOTES	SIZE (cm) ↓ ↓ ↓
0EPD04L0L00AA		46x19,5
0EPD04L0L00AB		46x19,5
0EPD04L0L00BB		46x19,5
0EPD04L0L00CC		46x19,5
0EPD04L0L00FF		46x19,5

Ideal for industrial floors, single-fired tiles, stoneware and woods with a medium degree of dirt

DUO FACE WASH SAFE - microfiber double-faced mop, wet mopping on non-slip floors

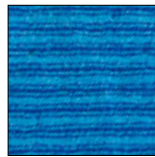

REF.	NOTES	SIZE (cm) ↓ ↓ ↓
00PD04L1L10AA		46x19,5

Ideal for non-slip floors with a medium degree of dirt and with stubborn dirt

Available while stocks last

DUO FACE DUST - ultra-microfiber double-faced mop, dry dusting

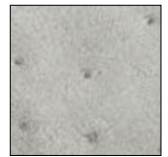

REF.	NOTES	SIZE (cm) ↓ ↓ ↓
00PD04S0S00EE		46x19,5

DUO FACE WASH BASIC/ SCRUBLY - microfiber double-faced mop, wet mopping / scrubbing action

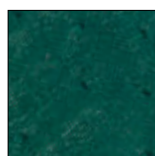
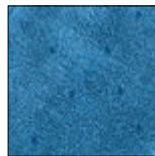
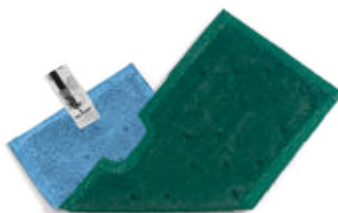

REF.	NOTES	SIZE (cm) ↓ ↓ ↓
00PD04L0L30AF		46x19,5
00PD04L0L30BF		46x19,5

Ideal for industrial surfaces, single-fired tiles and stoneware with Wash Basic side and anti-slip surfaces with Scrubly side, with a medium degree of dirt and with stubborn dirt

DUO FACE WASH BRUSH - ultra-microfiber double-faced mop, non-slip wet mopping

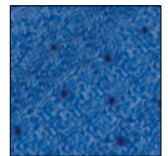

REF.	NOTES	SIZE (cm) ↓ ↓ ↓
0EPD04L5L50AA		46x19,5
0EPD04L5L50BB		46x19,5

Ideal for scrubbing and washing non-slip surfaces and natural terracotta with a high degree of dirt, characterized by stubborn dirt



MOP SYSTEM

TAB SYSTEM

POCKET SYSTEM

POCKET-TAB SYSTEM

STRAP TAPE SYSTEM

GLOBO SYSTEM

DUO FACE SYSTEM

DOSING HANDLES

DUO FACE WASH BASIC / BRUSH - ultra-microfiber double-faced mop, wet mopping/non-slip

DUO FACE WASH BASIC / DRY BARRIER - microfiber double-faced mop, wet mopping/dry, with waterproof barrier

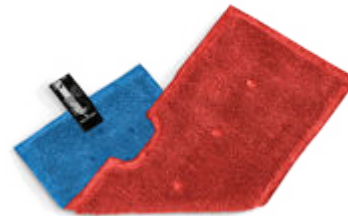
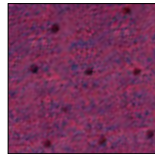

REF.	NOTES	SIZE (cm) ↓ ↓ ↓
0EPD04L0L50AA		46x19,5
0EPD04L0L50AB		46x19,5

REF.	NOTES	SIZE (cm) ↓ ↓ ↓
00PD04L0A01AA		46x19,5
00PD04L0A01AB		46x19,5

Wash Basic side ideal for industrial surfaces/floors, single-fired tiles and stoneware. Brush side ideal for scrubbing, non-slip floors and natural terracotta with high degree of stubborn dirt

Ideal for industrial floors, single-fired tiles, stoneware and woods with a medium degree of dirt



MOP SYSTEM

TAB SYSTEM

POCKET SYSTEM

POCKET-TAB SYSTEM

STRAP TAPE SYSTEM

GLOBO SYSTEM

DUO FACE SYSTEM

DOSING HANDLES

FLOOR CLEANING

Unilav is a wet mopping and/or disinfection tool for medium small areas, such as stairs, offices, bars, small shops with a medium degree of dirt. It is very useful for quick actions. In combination with microfiber cloths or with disposable cloths, it guarantees excellent cleaning results. Very simple and quick to use, light, handy and ergonomic.



Two types of refilling bottle: 650 ml and 1000 ml in different colours: red, blue, green and yellow.

The side-grip allows to regulate the release of cleaning solution: continuous flow or intermittent flow.



In order to have a complete disinfection system, Filmop offers also a **Unilav kit** that allows the operator to carry all the necessary equipment during the cleaning operations, optimizing working time.

Sanety tool is equipped with a special pierced "flowthrough" plate that allows a uniform distribution of the cleaning solution on the floor, thus avoiding waste of product.

HOW TO PREPARE IT

HOW TO USE IT

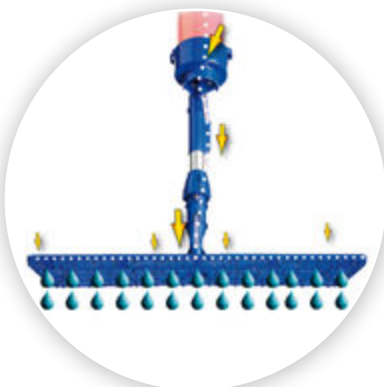

Lift up the plastic cover and fix it to the handle grip.



Fill in the tank.



Press and release the knob at the top of the grip for an intermittent wax flowing; press and block the knob for a continuous wax flowing.



The rubber cover on the knob on the handle grip avoids dirt and bacteria inside the hole and guarantees a more stable leaning of the tool against the walls.



Simple, quick and efficient cleaning

DROP

Drop is a **professional floor cleaning system** complete with tank handle with 500 ml capacity, aluminium mop holder and Skill-Fur microfibre mop.

Light, handy and easy to use, particularly advised for the cleaning in **medium-small environments** and in all those situations where a **fast and quick action** is required.

This system is characterized by a **well-finished, treated in detail design** for the highest practicality, speed and safety:

- **Intuitive, light and handy**, it reduces the operator's efforts and working time
- It allows to **dose the detergent solution** according to the surface and the degree of dirt
- **No spillage of cleaning solution** thanks to double safety lock acting on button and tank
- Its compact size allows to **clean easily also the hard-to reach areas**
- The reduced overall dimensions help to **store it easily even in the smallest closets** at the end of the cleaning operations



PATENTED SYSTEM

360°

360°

ERGOSWING JOINT

YouTube



Drop



ErgoDrop

ERGODROP

ErgoDrop combines the advantages of the professional Drop system with those of the innovative ergonomic ErgoSwing system, ensuring **maximum results with minimum effort**.

ErgoDrop is designed to **prevent the onset of professional illnesses**: the 360° rotation of the grips and the ergonomic design of the mop holder joint guarantee the health and well-being of the operator.

- **It doesn't force the operator to assume uncomfortable or asymmetrical positions**: it makes the S-movement easier, ensuring a correct posture during the cleaning operations.
- **It doesn't oblige the operator to make extreme wrist movements**: it reduces remarkably wrist flexion and extension movements compared to traditional systems, preventing fatigue.

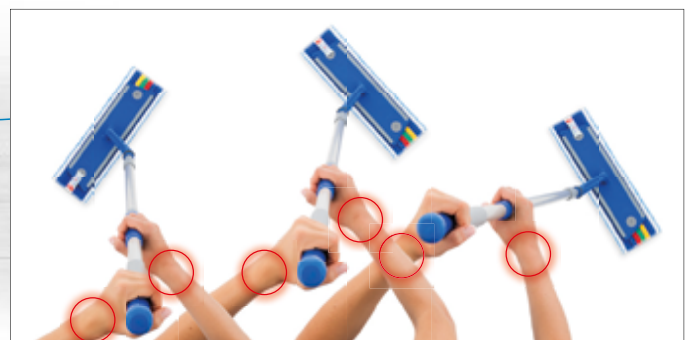



MOP SYSTEM

TAB SYSTEM

POCKET SYSTEM

POCKET-TAB SYSTEM

STRAP TAPE SYSTEM

GLOBO SYSTEM

DUO FACE SYSTEM

DOSING HANDLES

Unilav Side Grip

UNILAV SIDE GRIP - disinfection tool with refilling bottle 650 ml and Duo Face mop holder

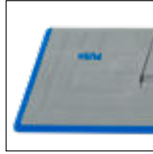

REF.	NOTES
0000TD0120A	

UNILAV SIDE GRIP - flat mop with 650ml bottle and holder with strap tapes



REF.	NOTES
0000TD0151A	with plate 40 cm
0000TD0151U	with plate 40 cm
0000TD0161A	with plate 60 cm

UNILAV SIDE GRIP - disinfection tool with refilling bottle 650 ml and cloth holder with Microplast strips 40 cm



REF.	NOTES
0000TD0145A	

UNILAV SIDE GRIP - disinfection tool with refilling bottle 650 ml and cloth holder with rubber lamellas 40 cm



REF.	NOTES
0000TD0130A	

MONO-TNT YELLOW - TNT disposable mop



REF.	NOTES	SIZE (cm)
0000PN02030	Pck: 10 polybags with 25 pcs each	↓ ↓ ↓ 20x42,5

For tools with blade plate



MOP SYSTEM

TAB SYSTEM

POCKET SYSTEM

POCKET-TAB SYSTEM

STRAP TAPE SYSTEM

GLOBO SYSTEM

DUO FACE SYSTEM

DOSING HANDLES

FLOOR CLEANING

Sanety

SANETY - disinfection tool with bottle 1,5 L



Disinfection mop for Sanety tool, mixed cotton



REF.	NOTES
8149	with plate 60 cm

Available while stocks last

REF.	NOTES	SIZE (cm)
8136		↓ ↓ ↓ 65x15

Drop - ErgoDrop

Kit **DROP** - tank handle 500 ml with aluminium mop holder 40 cm with strips for strap tape system, bordered Skill-Fur microfiber mop and dosing jug



REF.	NOTES
0002TD0652A	

Kit **ERGODROP** - tank handle 500 ml with aluminium mop holder 40 cm with strips for strap tape system with ErgoSwing fitting, bordered Skill-Fur microfiber mop and dosing jug



REF.	NOTES
0002TD0552A	



MOP SYSTEM

TAB SYSTEM

POCKET SYSTEM

POCKET-TAB SYSTEM

STRAP TAPE SYSTEM

GLOBO SYSTEM

DUO FACE SYSTEM

DOSING HANDLES

Components and accessories for dosing handles

Belt for Unilav kit



REF.	NOTES
Q0400108	

Blue plastic-coated bag for clean mops for Unilav kit



REF.	NOTES
Q0400105A	

Red plastic-coated bag for dirty mops for Unilav kit



REF.	NOTES
Q0400106B	

Blue plastic-coated bottle holder for Unilav kit



REF.	NOTES
Q0400107A	

Transparent refilling bottle with coloured screw cap for Unilav tool



REF.	CAPACITY (L)	SIZE (cm) ↓ ↓ ↓
P291029A	0,65	25,5
P291029B	0,65	25,5
P291029C	0,65	25,5
P291029F	0,65	25,5
P291030A	1	34
P291030B	1	34
P291030C	1	34
P291030F	1	34

Graduated plastic jar



REF.	NOTES
P191000T	3lt
P192000T	0,5L

Blue rubber cover for knob for Sanety and Slider kits



REF.	NOTES
P191084A	

Silicon tube



REF.	NOTES	SIZE (cm) ↓ ↓ ↓
P191045T	for Unilav tool	36
P191021T	for Sanety tool	40

DROP - tank handle 500 ml

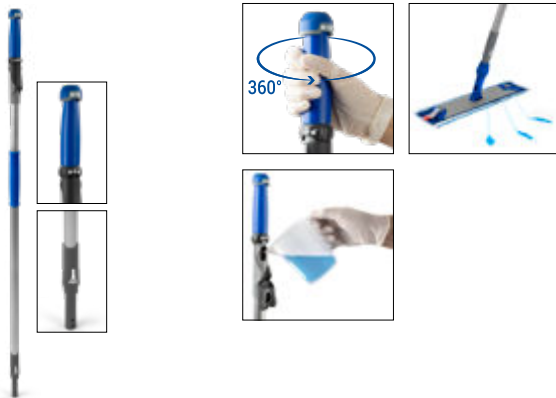

REF.	NOTES	SIZE (cm) ↓ ↓ ↓
0000TD0600A		142

The handle fits mop holders with traditional and Uni-Connect fitting

ERGODROP - tank handle 500 ml with turning grips for ErgoSwing system

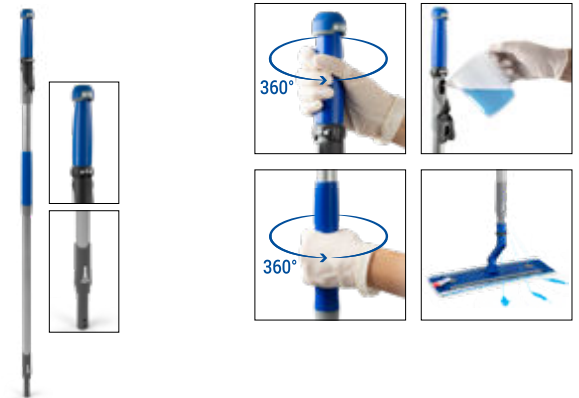

REF.	NOTES	SIZE (cm) ↓ ↓ ↓
0000TD0500A		142



Mop soaking systems



Mop soaking on demand and pre-soaking system





MOP SOAKING ON DEMAND AND PRE-SOAKING SYSTEM

WHY CHOOSE A MOP SOAKING SYSTEM?

Advantages:

- **Reduced risks of bacterial cross-contamination:** always clean detergent solution and use of one mop for each room
- **Environmentally friendly:** higher control of chemical solution with reduced chemical and water waste, lower environmental impact if compared with traditional mopping systems employing bucket and mop
- **Better ergonomics:** no rinsing and wringing; consequently, less effort for the operator and reduced costs for industrial accidents and illness leaves
- **Easy to use:** user-friendly, systems that make it easier to train the staff
- **Reduced costs for cleaning:** reduced working hours guarantee reduced labour costs
- **Excellent results in cleaning and hygiene:** thanks to the combination of mop soaking system and microfiber

MOP SOAKING SYSTEMS

Mop soaking system on demand:

Single mop soaking on demand directly on the trolley by means of the specific Equodose dosing station.



EQUODOSE system

Pre-soaking system:

Mop soaking system in advance, preparing the mops before use, normally in specific places, employing hermetic **Top-Down®** buckets or **plastic drawers**.



TOP-DOWN® system



System with drawers

COMPATIBILITY

Filmop mop soaking systems fit:



Strap tape system

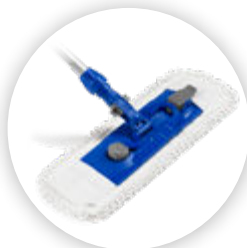

Pocket mop system



Duo Face system



Click Safe System



Globo system

Mop soaking system on demand



Alpha

Pre-soaking system



Vega Top-Down®



Arka Top-Down®



Morgan Top-Down®



Alpha

EQUODOSE®



Equodose is the innovating **mechanical dosing device** developed by Filmop to make the **mop soaking on demand** directly on site.

This system is designed with an **adjustable dosing mechanism** according to the features of the mops to use and the surfaces to clean.



YouTube



Advantages:

- **Prompt and ready in the working place:** mop soaking on demand and directly on site, just the necessary mops, even one single mop!
- **Minimum overall dimensions:** ideal in environments where there is a lack of big spaces to prepare and stock the pre-soaked mops and the hermetic buckets.
- **Eco-friendly product, low environmental impact:** water and detergent saving, as this system allows to soak only the necessary mops, eliminating any unnecessary washing of unused reserve mops in the washing machine. No need of electric power, no need of power supply, made of 100% recyclable plastic.
- **Easy to use:** just a few and simple steps and the mops are ready to use, high intuitive system.
- **Flexible:** you can regulate very accurately the right solution for each single mop according to the features of the surface to clean, the degree of dirt and the absorbing capacity of the mop.
- **High standards of hygiene:** reduction of cross-contamination risks, making easy and simple to clean each room with a different and ever clean mop. Tanks preserve active principles of some chemical solutions that could become less effective over time: this system is ideal for hospitals and healthcare facilities.

Features:

- **Totally mechanical and without electrical parts:** dosage is regulated by means of a graduated dial and operated thanks to a hand lever.
- **Strong and easy to maintain:** made of high quality polypropylene (Made in Italy), easy and low maintenance is required.
- **Safe and as by law enacted:** the graduated dial and tank can be blocked with the specific safety key device to avoid any tampering or improper use; hand level with push button to block the solution dispensing mechanism.
- **Modular design:** available with 1 or 2 tanks to increase the dosing system autonomy or to operate with two different detergents/ cleaning solutions at the same time.
- **Versatile:** fitting Alpha line of trolleys. Suitable for several kinds of mops and mop holders: strap tape system, pocket mop system, Globo system and Duo Face mop system (only fitting 40 cm mop systems).



MOP SOAKING ON DEMAND AND PRE-SOAKING SYSTEM

Dosing system

Increased flexibility: the 50 ml to 350 ml adjustable system ensures better detergent solution dosing precision also for the lightest cloths, such as surface mops for hand use, further reducing waste



MOP SOAKING SYSTEMS



Sealed reservoir

More effective: hermetic tank thanks to the internal washer of the cap, better preservation of the cleaning solution

Higher safety: the cap locking system improves the safety level

Better hygiene: the reservoir design facilitates easy cleaning and good long-term maintenance



Rotate the graduated dial from 50 ml to 350 ml to choose the right dose of solution. If necessary, remove the safety key to lock the dial and keep the right dosage.



Push the mechanical hand lever completely down.



Take a clean mop and lay it in the tray ready for soaking with the cleaning side downwards.
Wait for a few seconds for a complete and uniform mop soaking. This system is suitable for several kinds of mops, but only for 40 cm mop sizes.



MOP SOAKING ON DEMAND AND PRE-SOAKING SYSTEM

Click Safe: guaranteed hygiene, health protection

Click Safe is a **touchless cleaning system** consisting of folding mop holder and bucket with cover that can be combined with the mesh bag, designed to make operations easier, more hygienic and safer.



The mop holder hooks the mop easily and immediately while the cover instantly releases it directly into the bucket, the operator does not need to touch it with the hands and bend over.

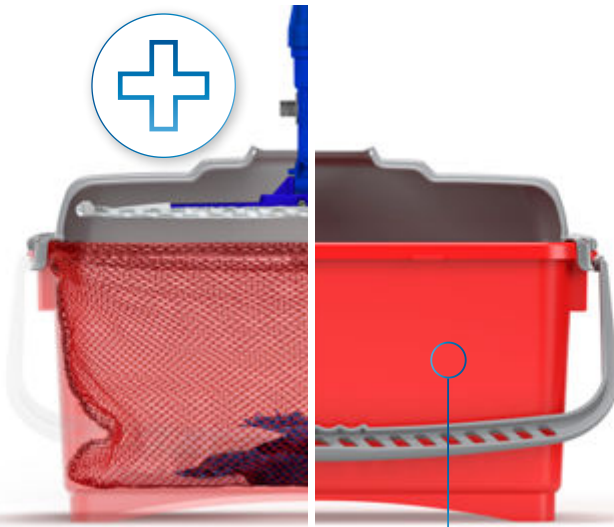

plastic
second life
MIX ECO

The special bag completes the job: placed in the bucket, it collects used mops making emptying and handling of laundry operations even faster and more hygienic.



Combining Click Safe with **soaking systems** helps to maintain a high level of hygiene throughout the cleaning procedure, lowering the risk of cross-contamination.

The **Equodose** mechanical dispenser for soaking on demand and **Top-Down** hermetic buckets for pre-soaking allow each area to be cleaned with a different mop or cloth while the touchless system allows them to be disposed of effectively preventing the spread of bacteria and viruses.





MOP SOAKING ON DEMAND AND PRE-SOAKING SYSTEM

Equodose

EQUODOSE - dosing device with one tank 6 L for mop soaking on demand



EQUODOSE - dosing device with two tanks 6 L for mop soaking on demand



REF.	NOTES	SIZE (cm) ↓ ↓ ↓
P320100UA	with EPDM seals	28x55x55
P320101UA	with Viton seals	28x55x55

△ ATTENTION: only for system 40 cm

REF.	NOTES	SIZE (cm) ↓ ↓ ↓
P320200UA	with EPDM seals	28x55x55
P320201UA	with Viton seals	28x55x55

△ ATTENTION: only for system 40 cm

Transparent tank 6 L with coloured cap complete with key



REF.	NOTES
P210017TA	with EPDM seals
P210017TB	with EPDM seals
P210022TA	with Viton seals
P210022TB	with Viton seals

Grey plastic bucket 4 L with coloured plastic handle on the edge



REF.	NOTES	SIZE (cm) ↓ ↓ ↓
0000SE0204U		16,5x21x22,5
0000SE0204UA		16,5x21x22,5
0000SE0204UB		16,5x21x22,5
0000SE0204UC		16,5x21x22,5
0000SE0204UF		16,5x21x22,5

Transparent plastic cover with hinges



REF.	NOTES
0000CP1204T	for bucket 4 L art. 0000SE0104
0000CP1205T	for 4l bucket item no. 0000SE0204
0000CP1206T	for bucket 6 L

Tray for mop soaking



REF.	NOTES
P110004A	

Standard key



REF.	NOTES
P110014U	

It allows to regulate the dosage, lock the tank and close the cap

Kit key to dose cleaning solution



REF.	NOTES
0000SM00286	

It allows to regulate the dial independently from the rest of the system with a specific key, different from the standard one - This option enable to a single operator to adjust the right quantity of cleaning solution



MOP SOAKING ON DEMAND AND PRE-SOAKING SYSTEM

Set for Equodose wall mounting

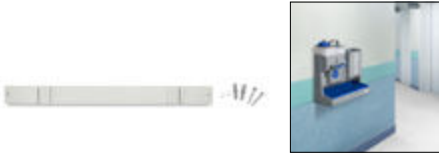

REF.	NOTES
0000SM00612	

Kit to fix Equodose on Morgan trolleys



REF.	NOTES
0000SM00613	

Buckets and drawers for pre-soaking

TOP-DOWN® 10 lt - plastic bucket with plastic handle and hermetic cover



REF.	NOTES	SIZE (cm)
0000SE1310A	Blue	24x55x19
0000SE1310B	Red	24x55x19

They are the ideal solution for cloth soaking procedures

TOP-DOWN® 20 lt - plastic bucket with plastic handle and hermetic cover



REF.	NOTES	SIZE (cm)
0000SE1322A	Blue	24x55x27
0000SE1322B	Red	24x55x27
0000SE1322U	Grey	24x55x27
0000SE1322UA	grey bucket with blue handle	Blue 24x55x27
0000SE1322UB	grey bucket with red handle	Red 24x55x27

They are the ideal solution for cloth soaking procedures

Plastic divider for Top-Down® bucket 20 lt



REF.	NOTES
P190350E	

The specific plastic reducer is ideal to keep the mop compact inside the bucket and to make it easier to pick up them from the bucket directly with the mop holder

Pierced plastic sieve for Top-Down® bucket



REF.	NOTES	SIZE (cm)
P1190041U	for Top-Down® 8 lt	33,3x14,2x2,2
P1190042U	for Top-Down® 10 and 20 lt	54x20x3

Ideal for a uniform distribution of the cleaning solution - For a quick pre-soaking (max 15 minutes)

Plastic sliding drawer without locking key



REF.	NOTES	CAPACITY (L)	SIZE (cm)
P1229909U	internal dimensions 41x34x9,5 cm	10	46,5x37,5x11
P1229906U	internal dimensions 40,5x34x16 cm	22	46,5x37,5x17

Pierced plastic sieve for mop soaking fitting drawers 10, 22 and 40 lt

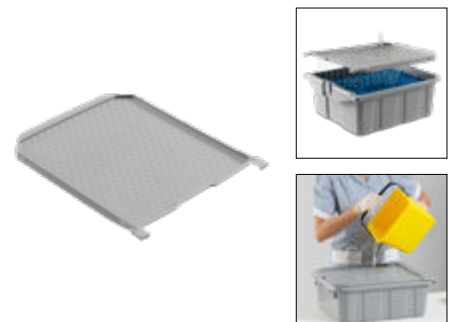

REF.	NOTES
P1909925U	

Ideal for a uniform distribution of the cleaning solution - For a quick pre-soaking (max 15 minutes)



MOP SOAKING ON DEMAND AND PRE-SOAKING SYSTEM

Pierced plastic sieve with high border for mop soaking fitting drawers 10, 22 and 40 lt

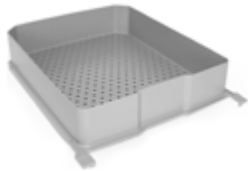

REF.	NOTES	SIZE (cm) ↓ ↓ ↓
P1909961U		46,5x36,5x10

Ideal for a uniform distribution of the cleaning solution
- For a quick pre-soaking (max 15 minutes)

Plastic cover for drawers 10, 22 and 40 lt



REF.	NOTES
P1909933U	

Graduated plastic jar



REF.	NOTES
P191000T	3lt
P192000T	0,5 L

MOP SOAKING SYSTEMS

Click Safe System

Plastic bucket 20 Lt with plastic handle



REF.	NOTES	SIZE (cm) ↓ ↓ ↓
0000SE1222A		24x55x27
0000SE1222B		24x55x27
0000SE1222U		24x55x27

Plastic cover for Click Safe system



REF.	NOTES	SIZE (cm) ↓ ↓ ↓
P190360U		55x23x12

Rilsan coated bucket holder with ø 80 mm wheel for 10/20 lt buckets, fitting the base of the Alpha trolleys



REF.	NOTES
R2200045	

Mesh bag with closing string



REF.	NOTES	CAPACITY (L)	SIZE (cm) ↓ ↓ ↓
0000AT0214B	stabilized polyester	35	65x46

MOP SOAKING ON DEMAND AND PRE-SOAKING SYSTEM

Trolley to carry soaked mops

POCKET - foldable metal trolley for Top-Down® buckets 10 and 20 lt



Rilsan coated trolley for Top-Down® buckets 10 and 20 L, with wheels ø 170 mm



REF.	NOTES
V2030122	

REF.	NOTES
R2030120	Fitting Morgan trolleys art.no. 0000MP8010A and 0000MP8020A

Rilsan coated trolley kit with wheels ø 200 mm with trolley locking device for Top-Down® buckets 10 and 20 lt



REF.	NOTES	SIZE (cm)
R3030162		32x60x94

Fitting Alpha trolleys - Recommended with supporting plate cod. P065060U



SEE MOPS/CLOTHS RANGE AND RELATED MOP HOLDERS IN THE FLOOR CLEANING LINE

Glass and surface cleaning line

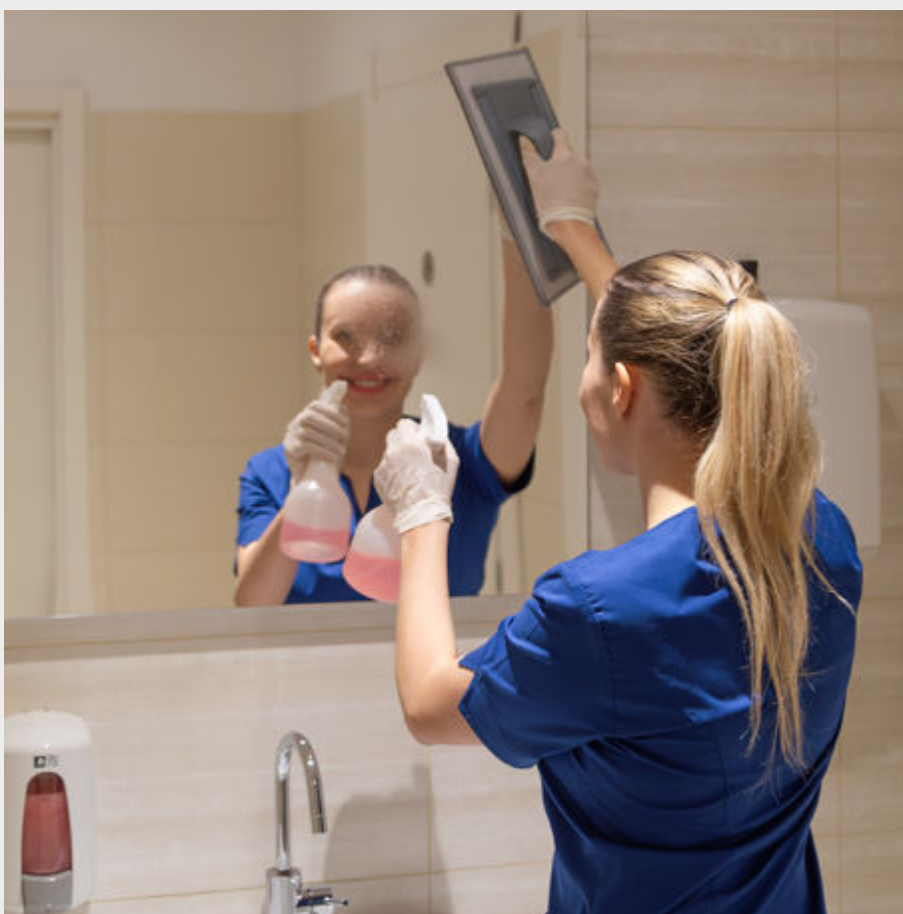

Window washers

Window squeegees

Telescopic poles

Brilliant system

Equipment for glass cleaning

Hand dusters

Manual cloths

Mono-Roll system

Top-Clean system





WINDOW WASHERS

WINDOW SQUEEGEES

TELESCOPIC POLES

BRILLIANT SYSTEM

EQUIPMENT FOR GLASS CLEANING

HAND DUSTERS

MANUAL CLOTHS

MONO-ROLL SYSTEM

TOP-CLEAN SYSTEM

A completely connected cleaning system

Glass, surfaces, floors: **Uni-Connect** gets everywhere by connecting the entire range of professional cleaning equipment. The operator can **quickly switch from one tool to another, easily cleaning any surface**, even the highest or hard-to-reach one.

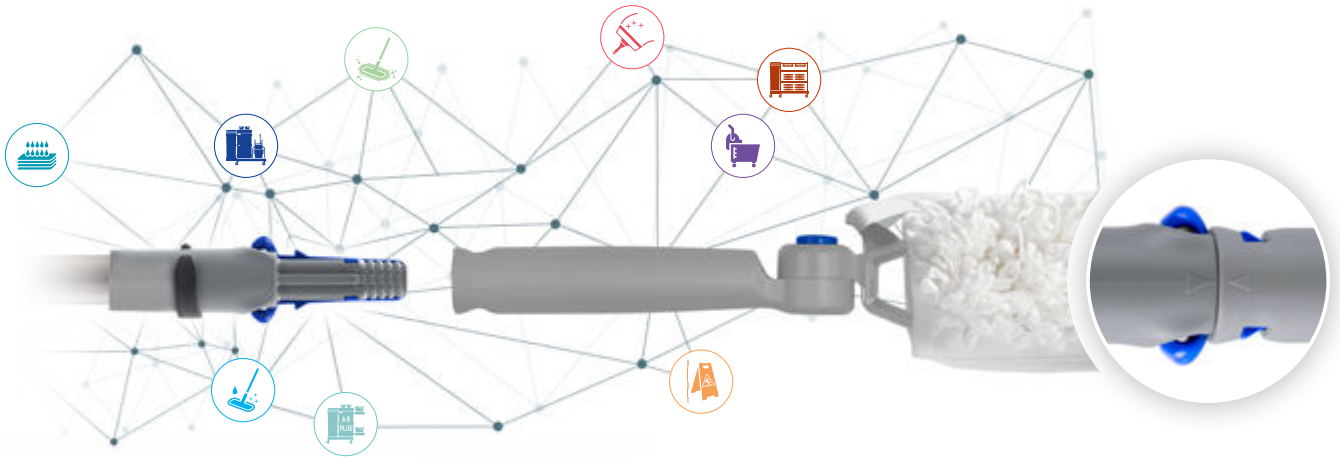

GLASS AND SURFACE CLEANING LINE

UNI-CONNECT
BETTER TOGETHER



DOWNLOAD THE CATALOGUE



Uni-Connect compatible products are marked with this symbol, browse the catalogue to discover them all!

Glass and surface cleaning line



WINDOW WASHERS

WINDOW SQUEEGEES

TELESCOPIC POLES

BRILLIANT SYSTEM

EQUIPMENT FOR GLASS CLEANING

HAND DUSTERS

MANUAL CLOTHS

MONO-ROLL SYSTEM

TOP-CLEAN SYSTEM

Uni-Connect connects **instantly and safely** all equipment required for cleaning of environments.

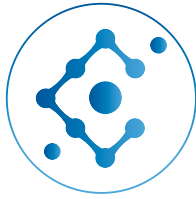

Univesal connection:
the end cone allows the same handle to be attached to any cleaning tool



Quick hooking:
attaching takes place instantly, without any complicated procedures



Safe fixing:
the equipment remains securely attached during cleaning operations

Do you need to optimise the equipment on the trolley?

Equipping OneFred and Alpha trolleys with the special connections gives you everything you need for thorough cleaning, minimising the size of the trolley.



GLASS AND SURFACE CLEANING LINE



- WINDOW WASHERS
- WINDOW SQUEEGEES
- TELESCOPIC POLES
- BRILLIANT SYSTEM
- EQUIPMENT FOR GLASS CLEANING
- HAND DUSTERS
- MANUAL CLOTHS
- MONO-ROLL SYSTEM
- TOP-CLEAN SYSTEM

NEW Effective glass cleaning

Window washers stand out for their **excellent collection power and high absorbency**. Made with **long, short or short yarn with bristles**, they perform considerably better than traditional sponges. The three versions are also available with an **abrasive fibre side**, ideal for **removing the most difficult dirt** from glass without scratching it.

SHINE
Unveiling the true beauty of glass



Compatible with Uni-Connect system and Italian thread

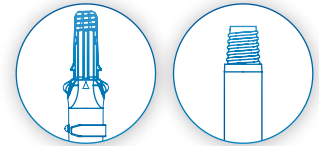

The high absorbency of the window washer sleeves results in **considerable water savings**

The window washer sleeves act together with their **supports, conceived for effectiveness and efficiency**:



CLARUS-W PRIME

It gradually releases the cleaning solution while washing the glass, ensuring **long-term soaking**.

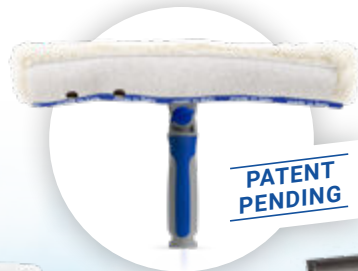

Jointed CLARUS-W MASTER

Besides the advantages of the fixed version, it provides a **rotation angle of up to 180°** that can be **freely locked** in any position.

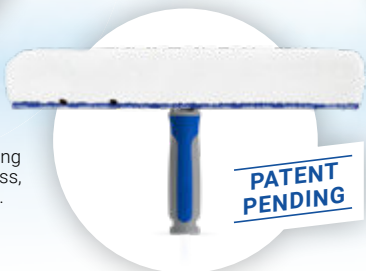

CLARUS-W MASTER

It has full surface adherence, making **dirt removal faster and more effective**.



GLOSS-W AMBO

It **combines** the strengths of the plastic squeegee with those of the fixed aluminium support **in a single tool**.

GLASS AND SURFACE CLEANING LINE



- WINDOW WASHERS
- WINDOW SQUEEGEES
- TELESCOPIC POLES
- BRILLIANT SYSTEM
- EQUIPMENT FOR GLASS CLEANING
- HAND DUSTERS
- MANUAL CLOTHS
- MONO-ROLL SYSTEM
- TOP-CLEAN SYSTEM

Supports and window washers

CLARUS-W PRIME - complete window washer polyester short yarn, with plastic support with Italian thread



REF.	NOTES	SIZE (cm)
9602		35
9603		45

Compatible with Uni-Connect system

CLARUS-W PRIME - complete window washer polyester short yarn with scrubbing fibres, with plastic support with Italian thread

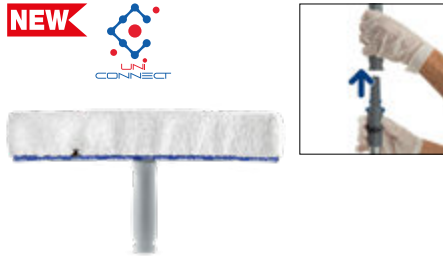

REF.	NOTES	SIZE (cm)
9902		35
9903		45

Compatible with Uni-Connect system

CLARUS-W PRIME - complete window washer acrylic long yarn with plastic support with Italian thread



REF.	NOTES	SIZE (cm)
9702		35
9703		45

Compatible with Uni-Connect system

CLARUS-W PRIME - complete window washer polyester short yarn with abrasive fibre, with plastic support with Italian thread

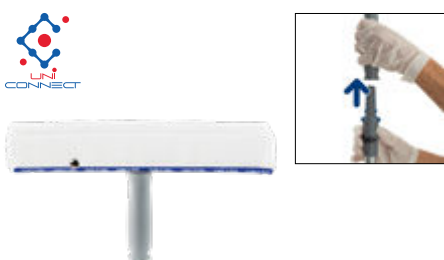

REF.	NOTES	SIZE (cm)
9632		35
9633		45

Compatible with Uni-Connect system

CLARUS-W PRIME - complete window washer polyester short yarn with scrubbing fibres and abrasive fibre, with plastic support with Italian thread

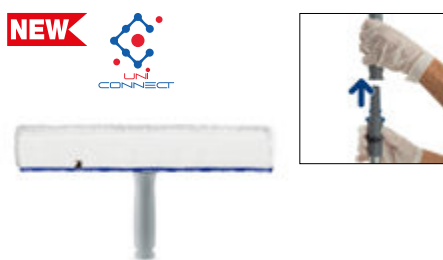

REF.	NOTES	SIZE (cm)
9932		35
9933		45

Compatible with Uni-Connect system

CLARUS-W PRIME - complete window washer acrylic long yarn with abrasive fibre, with plastic support with Italian thread



REF.	NOTES	SIZE (cm)
9732		35
9733		45

Compatible with Uni-Connect system

CLARUS-W PRIME - plastic support for washer sleeve with Italian thread



REF.	NOTES	SIZE (cm)
9241		25
9242		35
9243		45

Compatible with Uni-Connect system

CLARUS-W MASTER - aluminium support for washer sleeve with Italian thread

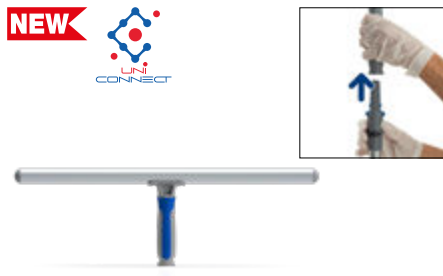

REF.	NOTES	SIZE (cm)
9344		55

Compatible with Uni-Connect system

CLARUS-W MASTER - jointed aluminium support for washer sleeve with Italian thread

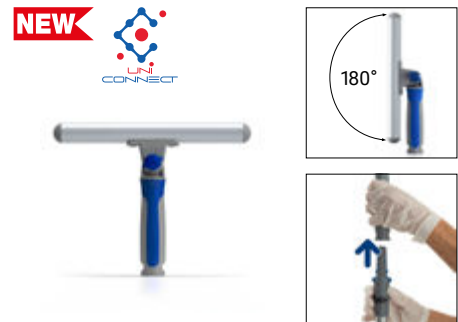

REF.	NOTES	SIZE (cm)
9441		25
9442		35
9443		45
9444		55

Compatible with Uni-Connect system



- WINDOW WASHERS
- WINDOW SQUEEGEES
- TELESCOPIC POLES
- BRILLIANT SYSTEM
- EQUIPMENT FOR GLASS CLEANING
- HAND DUSTERS
- MANUAL CLOTHS
- MONO-ROLL SYSTEM
- TOP-CLEAN SYSTEM

Polyester short yarn window washer sleeve



REF.	NOTES	SIZE (cm) ↓ ↓ ↓
9105		25
9106		35
9107		45
9108		55

Window washer sleeve short yarn with scrubbing fibres



REF.	NOTES	SIZE (cm) ↓ ↓ ↓
9405		25
9406		35
9407		45

Acrylic long yarn window washer sleeve



REF.	NOTES	SIZE (cm) ↓ ↓ ↓
9505		25
9506		35
9507		45

Polyester short yarn window washer sleeve with abrasive pad



REF.	NOTES	SIZE (cm) ↓ ↓ ↓
9135		25
9136		35
9137		45

Window washer sleeve short yarn with scrubbing fibres and abrasive pad



REF.	NOTES	SIZE (cm) ↓ ↓ ↓
9435		25
9436		35
9437		45

Acrylic long yarn window washer sleeve with abrasive pad



REF.	NOTES	SIZE (cm) ↓ ↓ ↓
9535		25
9536		35
9537		45

GLOSS-W AMBO - plastic window squeegee and sleeve with aluminium holder with Italian thread



REF.	NOTES	SIZE (cm) ↓ ↓ ↓
9952		35
9953		45

Compatible with Uni-Connect system

Plastic grip with window washer support for Gloss-W Ambo with Italian thread



REF.	NOTES	SIZE (cm) ↓ ↓ ↓
9561		25
9562		35
9563		45
9564		55

Compatible with Uni-Connect system



WINDOW WASHERS

WINDOW SQUEEGEES

TELESCOPIC POLES

BRILLIANT SYSTEM

EQUIPMENT FOR GLASS CLEANING

HAND DUSTERS

MANUAL CLOTHS

MONO-ROLL SYSTEM

TOP-CLEAN SYSTEM

NEW Professional window drying

The **window squeegees** in the range have been designed in detail to offer the best in performance and user-friendliness:

SHINE

Unveiling the true beauty of glass



Compatibility with Uni-Connect system and Italian thread

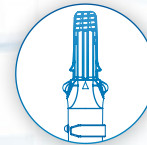

GLASS AND SURFACE CLEANING LINE

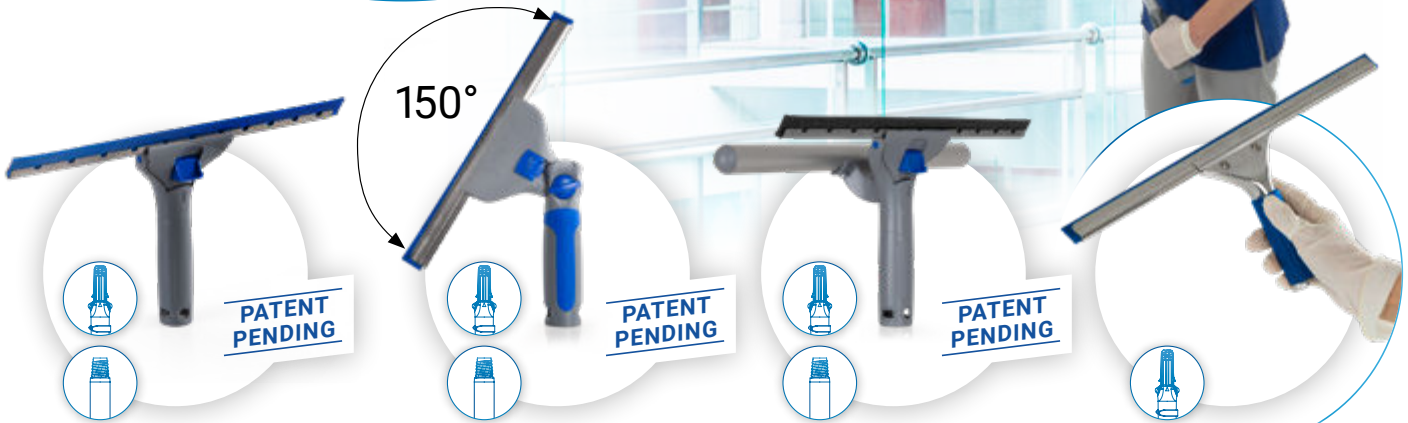

GLOSS-W PRIME

Features clamp fastening of the holder for maximum hold and the blade replacement system without removing the holder

Jointed GLOSS-W PRIME

In addition to the advantages of the fixed version, it offers a freely lockable rotation angle of up to 150° and a push-button system to quickly return to the central position.

GLOSS-W AMBO

A perfect symbiosis between the aluminium window washer support and the plastic window squeegee, which allows windows to be washed and dried with the same tool.

GLOSS-W SUPERIOR

Made of stainless steel to offer high strength and enhanced with a non-slip rubber coating to ensure a firm and secure grip.

The **fixed 30° angle** optimises cleaning and ergonomics ensuring high performance and user comfort.





WINDOW WASHERS

WINDOW SQUEEGEES

TELESCOPIC POLES

BRILLIANT SYSTEM

EQUIPMENT FOR GLASS CLEANING

HAND DUSTERS

MANUAL CLOTHS

MONO-ROLL SYSTEM

TOP-CLEAN SYSTEM

Available in blue or black, **the blade perfectly cleanses the surface in a single wipe**, ensuring significant time savings.

The closed-cell natural rubber construction **prevents the build-up of dirt and bacteria**, while the high resistance is provided by the vulcanisation treatment that **ensures a long service life**.

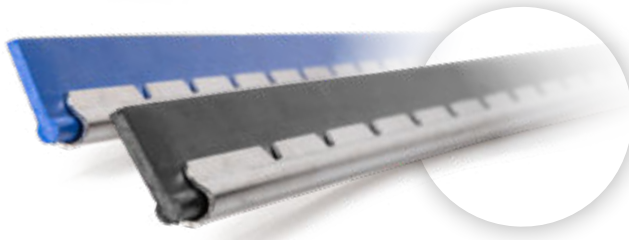

Window squeegees and replacements

GLOSS-W SUPERIOR - complete stainless steel squeegee with blue rubber blade

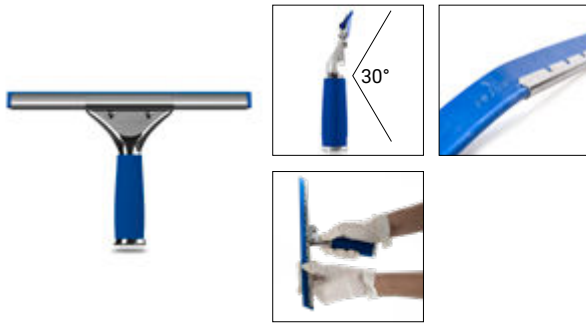

REF.	NOTES	SIZE (cm) ↓ ↓ ↓
9451A		25
9452A		35
9453A		45
9454A		55

Compatible with Uni-Connect system

GLOSS-W SUPERIOR - stainless steel window squeegee

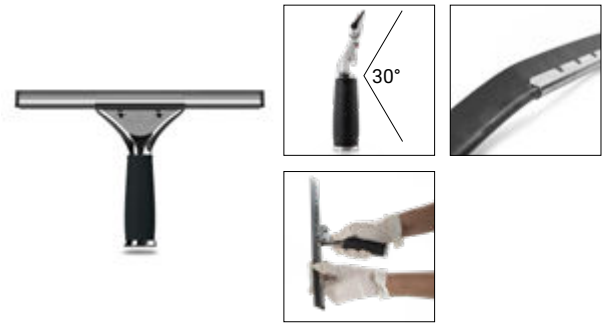

REF.	NOTES	SIZE (cm) ↓ ↓ ↓
9451		25
9452		35
9453		45
9454		55

Compatible with Uni-Connect system

GLOSS-W PRIME - complete plastic squeegee with Italian thread and blue rubber blade



REF.	NOTES	SIZE (cm) ↓ ↓ ↓
9551A		25
9552A		35
9553A		45
9554A		55

Compatible with Uni-Connect system

GLOSS-W PRIME - complete plastic window squeegee with Italian thread



REF.	NOTES	SIZE (cm) ↓ ↓ ↓
9551		25
9552		35
9553		45
9554		55

Compatible with Uni-Connect system



WINDOW WASHERS

WINDOW SQUEEGEES

TELESCOPIC POLES

BRILLIANT SYSTEM

EQUIPMENT FOR GLASS CLEANING

HAND DUSTERS

MANUAL CLOTHS

MONO-ROLL SYSTEM

TOP-CLEAN SYSTEM

GLOSS-W PRIME - complete jointed plastic squeegee with Italian thread and blue rubber blade

NEW

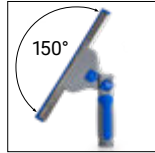
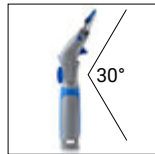

REF.	NOTES	SIZE (cm) ↓ ↓ ↓
9751A		25
9752A		35
9753A		45
9754A		55

Compatible with Uni-Connect system

GLOSS-W PRIME - complete plastic jointed window squeegee with Italian thread

NEW

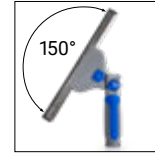
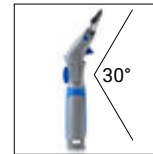

REF.	NOTES	SIZE (cm) ↓ ↓ ↓
9751		25
9752		35
9753		45
9754		55

Compatible with Uni-Connect system

Stainless steel grip for blue window squeegee Gloss-W Superior



REF.	NOTES
9661A	

Compatible with Uni-Connect system

Stainless steel grip for window squeegee Gloss-W Superior



REF.	NOTES
9661	

Compatible with Uni-Connect system

Plastic grip for Gloss-W Prime window squeegee with Italian thread

NEW



REF.	NOTES
9861	

Compatible with Uni-Connect system

Plastic grip for Gloss-W Prime jointed window squeegee with Italian thread

NEW



REF.	NOTES
9761	

Compatible with Uni-Connect system



WINDOW WASHERS

WINDOW SQUEEGEES

TELESCOPIC POLES

BRILLIANT SYSTEM

EQUIPMENT FOR GLASS CLEANING

HAND DUSTERS

MANUAL CLOTHS

MONO-ROLL SYSTEM

TOP-CLEAN SYSTEM

Stainless steel channel with blue rubber blade for window squeegee



Stainless steel channel with rubber blade for window squeegee



REF.	NOTES	SIZE (cm) ↓ ↓ ↓
9363A		25
9364A		35
9365A		45
9366A		55

REF.	NOTES	SIZE (cm) ↓ ↓ ↓
9363		25
9364		35
9365		45
9366		55

Rubber blade for window squeegee



REF.	NOTES	SIZE (cm) ↓ ↓ ↓
9271		92
9272		71
9376		55
9375		45
9374		35
9373		25

Blue rubber blade for window squeegee

NEW



REF.	NOTES	SIZE (cm) ↓ ↓ ↓
9271A		92
9272A		71



WINDOW WASHERS

WINDOW SQUEEGEES

TELESCOPIC POLES

BRILLIANT SYSTEM

EQUIPMENT FOR GLASS CLEANING

HAND DUSTERS

MANUAL CLOTHS

MONO-ROLL SYSTEM

TOP-CLEAN SYSTEM

NEW Fast and safe operations when working at height

The **aluminium poles with Uni-Connect cone** allow you to **quickly and safely reach higher surfaces** without ladders. The innovative cone **immediately and firmly attaches** to the tools, keeping them secured during cleaning operations. They are available in **one-, two- or three-piece versions with different lengths** to suit every need.

PATENT PENDING

SHINE
Unveiling the true beauty of glass

i
Compatible with Uni-Connect system and Italian thread

GLASS AND SURFACE CLEANING LINE

Spectra-W Pro is the evolution of the pole, designed to offer important advantages:

- the **anti-twist system** prevents the tubes from twisting together, making it easier to extend the pole and ensuring **greater stability during use**;
- the **fast opening and closing plastic ring** makes **adjusting the pole** to the desired height fast and **effortless**;
- the **ergonomic, non-slip rubber grip of the 2-piece and 3-piece versions** facilitates a **firm hold even with wet hands** and prevents the pole from slipping when resting vertically;
- the practical **hole** allows **water to drain** away when washing surfaces and allows **the 1- and 2-piece versions to be hung**.



WINDOW WASHERS

WINDOW SQUEEGEES

TELESCOPIC POLES

BRILLIANT SYSTEM

EQUIPMENT FOR GLASS CLEANING

HAND DUSTERS

MANUAL CLOTHS

MONO-ROLL SYSTEM

TOP-CLEAN SYSTEM

Aluminium poles

Aluminum pole complete with cone with Italian thread for Uni-Connect system

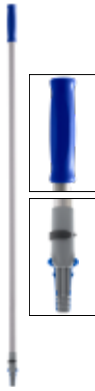

REF.	NOTES	SIZE (cm) ↓ ↓ ↓
00059880A	1 pc x 1,25 m	125
0005AS28150A	1 pc x 1,5 m	150

Learn more about Uni-Connect in the glass and surfaces section

Aluminum telescopic pole complete with end cone with Italian thread for Uni-Connect system – 2 pieces

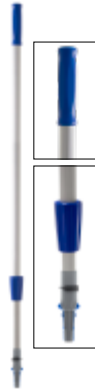

REF.	NOTES	SIZE (cm) ↓ ↓ ↓
00059879A	2 pcs x 0,60 m	120
00059881A	2 pcs x 1,25 m	250
00059878A	2 pcs x 1,50 m	300
00059882A	2 pcs x 2,00 m	400
00059883A	2 pcs x 3,00 m	600

Learn more about Uni-Connect in the glass and surfaces section

Aluminum telescopic pole complete with end cone with Italian thread for Uni-Connect system – 3 pieces

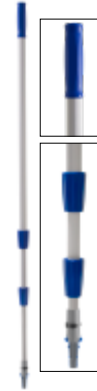

REF.	NOTES	SIZE (cm) ↓ ↓ ↓
00059886A	3 pcs x 1,00 m	300
00059887A	3 pcs x 1,50 m	450
00059884A	3 pcs x 2,00 m	600
00059885A	3 pcs x 3,00 m	900
00059890A	2 pcs x 4,00 m + 1 pc x 3,00 m	1100

Learn more about Uni-Connect in the glass and surfaces section

SPECTRA-W PRO - Aluminum pole complete with cone with Italian thread for Uni-Connect system

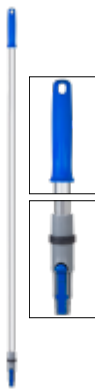

REF.	NOTES	SIZE (cm) ↓ ↓ ↓
0005AS01150A	1 pc x 1,50 m	150

Learn more about Uni-Connect in the glass and surfaces section

SPECTRA-W PRO - Aluminum telescopic pole complete with end cone with Italian thread for Uni-Connect system – 2 pieces

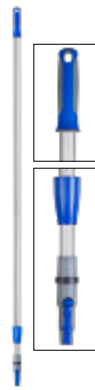

REF.	NOTES	SIZE (cm) ↓ ↓ ↓
0005AS02100A	2 pcs x 1,00 m	200
0005AS02125A	2 pcs x 1,25 m	250
0005AS02150A	2 pcs x 1,50 m	300
0005AS02200A	2 pcs x 2,00 m	400
0005AS02250A	2 pcs x 2,50 m	500
0005AS02300A	2 pcs x 3,00 m	600

Learn more about Uni-Connect in the glass and surfaces section

SPECTRA-W PRO - Aluminum telescopic pole complete with end cone with Italian thread for Uni-Connect system – 3 pieces



REF.	NOTES	SIZE (cm) ↓ ↓ ↓
0005AS03100A	3 pcs x 1,00 m	300
0005AS03150A	3 pcs x 1,50 m	450
0005AS03200A	3 pcs x 2,00 m	600
0005AS03300A	3 pcs x 3,00 m	900

Learn more about Uni-Connect in the glass and surfaces section



WINDOW
WASHERS

WINDOW
SQUEEGEES

**TELESCOPIC
POLES**

BRILLIANT
SYSTEM

EQUIPMENT FOR
GLASS CLEANING

HAND DUSTERS

MANUAL
CLOTHS

MONO-ROLL
SYSTEM

TOP-CLEAN
SYSTEM

Accessories for poles

End cone with Italian thread for telescopic handles and poles with Uni-Connect system



REF.	NOTES
P179047UA	for handles ø 23 mm
P179049UA	for poles ø 21 mm

Learn more about Uni-Connect in the glass and surfaces section

Joint for telescopic pole with Italian thread

NEW



REF.	NOTES
P179078UA	for handles ø 23 mm
P179079UA	for poles ø 21 mm

American thread cone for Uni-Connect system

NEW



REF.	NOTES
P179032U	

Learn more about Uni-Connect in the glass and surfaces section

End cone with Italian screw for telescopic pole



REF.	NOTES
9089/2A	

Cranked joint for telescopic pole



REF.	NOTES
9088A	

Hook for telescopic pole



REF.	NOTES
9096A	

Grey laquered wooden and metal display stand for handles and telescopic poles



REF.	NOTES	SIZE (cm)
P06000		45x45x41



WINDOW WASHERS

WINDOW SQUEEGEES

TELESCOPIC POLES

BRILLIANT SYSTEM

EQUIPMENT FOR GLASS CLEANING

HAND DUSTERS

MANUAL CLOTHS

MONO-ROLL SYSTEM

TOP-CLEAN SYSTEM

Brilliant window cleaning system is the ideal solution for the cleaning of vertical smooth surfaces like interior window cleaning, mirrors, stainless steel surfaces, lacquered surfaces, painted doors, etc.

- **Fast:** the light and handy mop holder and the ultra-microfiber mop combined with a specific alcoholic-based detergent for surfaces, guarantee shining surfaces with just one wipe
- **High performance:** thanks to its excellent features, the specific ultra-microfiber mop removes fingerprints, smears, dust particles and dirt with excellent cleaning results
- **Efficient:** the use of a flat mop holder guarantees a considerable working time reduction in comparison with traditional hand cleaning systems and a perfect adherence of the mop holder to the surface
- **Ergonomic:** a handy and ergonomic cleaning system both with mop holder with hand grip and with mop holder combined with telescopic handle to safely reach also the highest areas



YouTube



■ Holders and cloths for Brilliant system

Mop holder with strips for strap tape system with Uni-Connect joint and end cone and Lock System

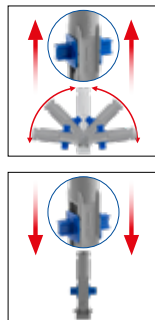

Mop holder with strips for strap tape system with Lock System



REF.	NOTES	SIZE (cm) ↓ ↓ ↓
0000TP1817U		30x8

Learn more about Uni-Connect in the glass and surfaces section

REF.	NOTES	SIZE (cm) ↓ ↓ ↓
5388U		30x8
5389U		40x8



WINDOW WASHERS

WINDOW SQUEEGEES

TELESCOPIC POLES

BRILLIANT SYSTEM

EQUIPMENT FOR GLASS CLEANING

HAND DUSTERS

MANUAL CLOTHS

MONO-ROLL SYSTEM

TOP-CLEAN SYSTEM

TOP-CLEAN - plastic mop holder with grip and strips 2,5 cm for strap tape system



REF.	NOTES	SIZE (cm) ↓ ↓ ↓
5233U		30
5234U		40

Mop holder used with Brilliant system for cleaning interior glass, mirrors and all smooth vertical surfaces and with Top Clean system for cleaning tables in cafeterias, bars, kitchens, restaurants...

Ultra-microfiber mop head with backing for strap tape system



REF.	NOTES	SIZE (cm) ↓ ↓ ↓
0000PN02016		30x11
0000PN03016		40x11

Ideal for stainless steel surfaces, mirrors and windows

MICRO-ACTIVA - ultra-microfiber mop, polyester backing, with strap tape system and colour-coded tag



REF.	NOTES	SIZE (cm) ↓ ↓ ↓
000EPN02012		30
000EPN03012		40
000EPN03022		60

Ideal for industrial floors, single-fired tiles, stoneware and woods with a medium degree of dirt

Kit BRILLIANT



REF.	NOTES
0000SM00619	
0000PN02016	Ultra-microfiber cloths with backing for strap tape system, 30 cm 5 pcs
5233U	TOP-CLEAN - plastic mop holder with grip and strips 2,5 cm for strap tape system 1 pc.

Standard cleaning kit for easily accessible shiny surfaces

Kit BRILLIANT PLUS



REF.	NOTES
0000SM00621	
0000AM3090A	Telescopic anodized aluminium handle 2 pcs with grey ergonomic grip, extension from 56 till 93 cm and blue cap 1 pc.
0000PN02016	Ultra-microfiber cloths with backing for strap tape system, 30 cm 2 pcs
0000TP1817U	Mop holder with strips for strap tape system with Uni-Connect joint and end cone, 30x8 cm 1 pc.
000EPN02012	MICRO-ACTIVA - ultra-microfiber mop with strap tape system, with colour-coded tag, 30 cm 1 pc.
5233U	TOP-CLEAN - plastic mop holder with grip and strips 2,5 cm for strap tape system 1 pc.

Complete kit for the cleaning of shiny surfaces, easily reachable



WINDOW WASHERS

WINDOW SQUEEGEES

TELESCOPIC POLES

BRILLIANT SYSTEM

EQUIPMENT FOR GLASS CLEANING

HAND DUSTERS

MANUAL CLOTHS

MONO-ROLL SYSTEM

TOP-CLEAN SYSTEM

Accessories for Brilliant system

2-piece anodized aluminium telescopic handle with ergonomic grip and coloured cap

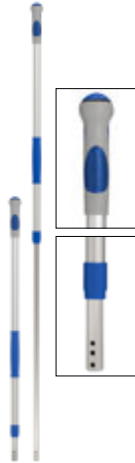

Plastic carry basket complete with 3 dividers and grip



Plastic carry basket with special shaped bottle holder, 2 compartments and fixed grip



REF.	NOTES	SIZE (cm)
		↓ ↓ ↓
0000AM3070A	blue, with blue cap	184
0000AM3070UU	grey, with grey cap	184
0000AM3070UA	grey, with blue cap	184
0000AM3070UB	grey, with red cap	184
0000AM3070UC	grey, with yellow cap	184
0000AM3070UF	grey, with green cap	184
0000AM3090A	blue, with blue cap	93

REF.	NOTES	SIZE (cm)
		↓ ↓ ↓
3669U		32,5x25x31

REF.	NOTES	SIZE (cm)
		↓ ↓ ↓
3690U		33,5x28,3x27

Art. 0000AM3070 extendable from 102 to 184 cm - Art. 0000AM3090A extendable from 56 to 93 cm - External tube ø 26 mm, internal tube ø 23 mm

Spare strip for strap tape system plastic mop holders



Round cloth star fixing clip



REF.	NOTES
P191085U	for mop holder 30 cm long side (23,3 cm)
P191077U	for mop holder 30 cm short side (20 cm)
P191068U	for mop holder 40 cm long side (35,4 cm)
P191069U	for mop holder 40 cm short side (32 cm)
P191071U	for mop holder 60 cm long side (52,2 cm)
P191070U	for mop holder 60 cm short side (48,6 cm)

REF.	NOTES
60062U	



WINDOW WASHERS

WINDOW SQUEEGEES

TELESCOPIC POLES

BRILLIANT SYSTEM

EQUIPMENT FOR GLASS CLEANING

HAND DUSTERS

MANUAL CLOTHS

MONO-ROLL SYSTEM

TOP-CLEAN SYSTEM

Scrapers

CLIP - scraper with 10 blades			Blades for Clip scraper			Pocket scraper without blades			Blades for pocket scraper		
REF.	NOTES	SIZE (cm) ↓ ↓ ↓	REF.	NOTES	SIZE (cm) ↓ ↓ ↓	REF.	NOTES	SIZE (cm) ↓ ↓ ↓	REF.	NOTES	SIZE (cm) ↓ ↓ ↓
9316		10x2,4	9317	1 pc art. 9317 = 100 blades	10x2x0,02	9091		9,5x4,5	9095	1 pc art. 9095 = 100 blades	4x2,5x0,023
To be used only with handgrips code 9661											

Cobweb brushes

Cobweb brush		C-shaped cobweb brush		End cone with Italian thread for telescopic handles and 3-hole aluminum handles ø 23 mm	
REF.	NOTES	REF.	NOTES	REF.	NOTES
9214	with Italian screw	9215	with Italian screw	P179040A	
9314	with American screw	9315	with American screw		
The version with Italian thread is compatible with Uni-Connect system		The version with Italian thread is compatible with Uni-Connect system			
End cone with Italian thread for telescopic handles and poles with Uni-Connect system		Set 6 pcs adapter with American thread for hand dusters and cobweb brushes			
REF.	NOTES	REF.	NOTES		
P179047UA	for handles ø 23 mm	0000SM00038U			
P179049UA	for poles ø 21 mm				
Learn more about Uni-Connect in the glass and surfaces section					



WINDOW WASHERS

WINDOW SQUEEGEES

TELESCOPIC POLES

BRILLIANT SYSTEM

EQUIPMENT FOR GLASS CLEANING

HAND DUSTERS

MANUAL CLOTHS

MONO-ROLL SYSTEM

TOP-CLEAN SYSTEM

Window cleaning set

Kit for window cleaning

NEW



REF.	NOTES	SIZE (cm) ↓ ↓ ↓
9130		146x13x24,5
00059881A	Aluminium pole with cone for Uni-Connect system, 2x1.25 m	1 pc.
9088A	Cranked joint for telescopic pole	1 pc.
9271	Rubber blade for window squeegee 92 cm, Filmop line	1 pc.
9316	CLIP - scraper with 10 blades	1 pc.
9363	Stainless steel channel with rubber blade for window squeegee 25 cm, Filmop line	1 pc.
9364	Stainless steel channel with rubber blade for window squeegee 35 cm, Filmop line	1 pc.
9365	Stainless steel channel with rubber blade for window squeegee 45 cm, Filmop line	1 pc.
9406	Window washer sleeve short yarn with scrubbing fibres, 35 cm	1 pc.
9602	CLARUS-W PRIME - window washer polyester short yarn with fixed plastic support with Italian thread, 35 cm	1 pc.
9661	Stainless steel grip for window squeegee, Filmop line	1 pc.
9851	Floor scraper with plastic grip	1 pc.
TCH201020	POWER-T - ultramicrofibre wiping cloth, 40x40 cm, blue	5 pcs

SHINE - glass line trolley

NEW



REF.	SIZE (cm) ↓ ↓ ↓
0000LP2310U	78x58x120

20 lt plastic bucket with plastic handle complete with sieve and squeegee holder

NEW



REF.	NOTES	SIZE (cm) ↓ ↓ ↓
0002SE1222A		24x55x27

Window squeegees support for 10 and 20 lt buckets

NEW



REF.	NOTES
P190351U	

Manual plastic sleeve wringer

NEW



REF.	NOTES
P190015A	

Wheel ø 50 mm



REF.	NOTES
7949	For King, Spider, Ro-cket Wheels, Duo Pro System, Prisma, Twin, Top-Down®, Pick-Up, Trend and code 0000SE1428

Glass and surface cleaning line



WINDOW WASHERS

WINDOW SQUEEGEES

TELESCOPIC POLES

BRILLIANT SYSTEM

EQUIPMENT FOR GLASS CLEANING

HAND DUSTERS

MANUAL CLOTHS

MONO-ROLL SYSTEM

TOP-CLEAN SYSTEM

The **belt with pockets** keeps **equipment within easy reach**, making it a valuable ally when cleaning surfaces with hand cloths and washing floors with tools with tanks.

The adjustable fastening makes it universal and **can be quickly adapted to the operator**. It is supplied with **two practical pockets** and can be equipped with a **practical bag-holder ring** according to your needs.



Pocket to hold tools with divider to optimise space



Pocket with buttons for secure fastening of the bag



Bag holder ring to collect small waste products



GLASS AND SURFACE CLEANING LINE

Adjustable belt with 2 pockets for tools

NEW



REF.

NOTES

Q0400208

Plastic ring to hold polybags for belt

NEW

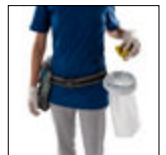

REF.

NOTES

P190017H



SNAKE: shapeable hand duster

Designed with a much more flexible and stronger plastic support, Snake can be used on both irregular and rounded surfaces for high-quality and more effective performances.

The hand duster is available also in the version equipped with **cloth fixing star-clips** to fix the disposable cloths and with a **practical push button** in the joint that allows to bend the hand duster support very quickly.



Shapeable to clean both irregular and rounded surfaces

Removing the cap from the handgrip, the dusters can be used with handles with thread, poles with Uni-Connect cone \varnothing 21 mm and telescopic handles with Uni-Connect cone \varnothing 23 mm



YouTube



Flatty: the hand duster that makes cleaning easier

The innovating **Flatty** hand duster is ideal to clean all surfaces thanks to its ultra flexibility.

PATENTED SYSTEM

- **Designed to be used with multipurpose cloths** for the cleaning of surfaces, till now used only by hand.
- **The cloths are rolled up on the hand duster support** and can be fixed thanks to the specific fixing clips.
- **The width of the hand duster** allows a quick and efficient dusting operation in a few simple steps.

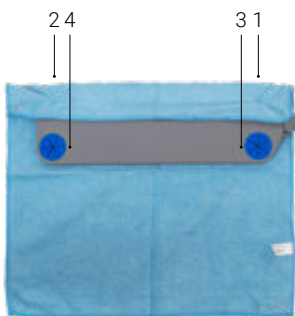

Wrap the cloth and fix it thanks to the **four clips**

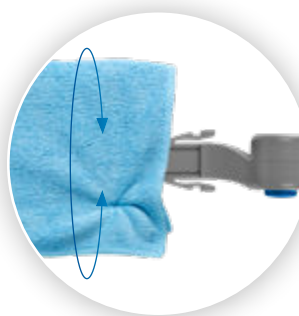

Turn **360°** to clean a bigger surface



Push the button and **bend to 270°** to clean even the hard-to-reach areas



WINDOW WASHERS

WINDOW SQUEEGEES

TELESCOPIC POLES

BRILLIANT SYSTEM

EQUIPMENT FOR GLASS CLEANING

HAND DUSTERS

MANUAL CLOTHS

MONO-ROLL SYSTEM

TOP-CLEAN SYSTEM

Spillo-Snake hand dusters

Shapable rubber mop holder with cloth fixing clips and grip with Italian thread for **SNAKE** hand duster

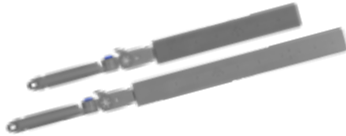

REF.	NOTES	SIZE (cm) ↓ ↓ ↓
2440U		40
2640U		60

Suitable for use with QUIK-STIK disposable cloths

Plastic mop holder with grip with Italian thread for **SPILLO** hand duster

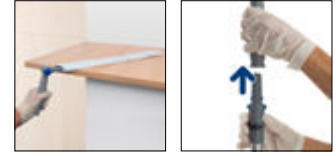

REF.	NOTES	SIZE (cm) ↓ ↓ ↓
2460U		40
2660U		60

Suitable for use with QUIK-STIK disposable cloths

Acrylic sleeve for hand dusters **SPILLO** and **SNAKE**



REF.	NOTES	SIZE (cm) ↓ ↓ ↓
1084A		40
2084A		60

Microfiber sleeve for **SPILLO** and **SNAKE** hand dusters, 1 side long yarn_1 side short yarn



REF.	NOTES	SIZE (cm) ↓ ↓ ↓
1086		40
2086		60

Microfiber short sleeve for hand dusters **SPILLO** e **SNAKE**



REF.	NOTES	SIZE (cm) ↓ ↓ ↓
1085	<input type="checkbox"/>	40
1085A	<input checked="" type="checkbox"/>	40
2085	<input type="checkbox"/>	60
2085A	<input checked="" type="checkbox"/>	60

QUIK-STIK - Disposable cloth with glue for Spillo and Snake hand dusters



REF.	NOTES	SIZE (cm) ↓ ↓ ↓
00PU0102000	Pkg: 20 polybags with 12 pcs each	40
00PU0102001	Pkg: 20 polybags with 12 pcs each	60

Code 00PU0102000 available while supplies last



WINDOW WASHERS

WINDOW SQUEEGEES

TELESCOPIC POLES

BRILLIANT SYSTEM

EQUIPMENT FOR GLASS CLEANING

HAND DUSTERS

MANUAL CLOTHS

MONO-ROLL SYSTEM

TOP-CLEAN SYSTEM

Flatty hand duster

FLATTY - plastic mop holder with grip with Italian thread for dusting with microfiber mops

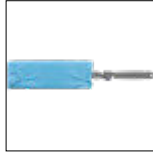

FLATTY - plastic hand duster for microfiber cloths



REF.	NOTES	SIZE (cm) ↓ ↓ ↓
2430U		11x54

Suitable for 40x40 cm microfibre dust cloths (see the Touch cloth section)

REF.	NOTES	SIZE (cm) ↓ ↓ ↓
1430		11x54

Adaptable to telescopic poles and aluminium handles - Suitable for 40x40 cm microfibre dust cloths (see the Touch cloth section)

Available while stocks last

QUIK-STIK - Disposable cloth with glue for Flatty holder



REF.	NOTES	SIZE (cm) ↓ ↓ ↓
00PU0102002	Pck: 10 polybags with 25 pcs each	31x38

Available while stocks last



WINDOW WASHERS

WINDOW SQUEEGEES

TELESCOPIC POLES

BRILLIANT SYSTEM

EQUIPMENT FOR GLASS CLEANING

HAND DUSTERS

MANUAL CLOTHS

MONO-ROLL SYSTEM

TOP-CLEAN SYSTEM

Daster: foldable hand duster

Daster is a hand duster designed to overcome any limit:

- Its forked part allows to **clean even the most difficult to reach surfaces**
- Its practical push-button allows to **bend the hand duster up to 240°** in order to adapt it to the surface to clean
- The mop fixing system allows to **secure the mop**
- Suitable for telescopic handles and poles to **reach also the highest areas**



240°



Equipped with a **100% acrylic spare mop**, it traps and keeps effectively even the smallest particle of dust.



GLASS AND SURFACE CLEANING LINE

Daster hand duster

DASTER - acrylic hand duster with grip with Italian thread, single packed

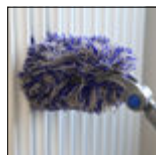

REF. NOTES

2013

Ideal packaging for resale

Acrylic mop for hand duster **DASTER**



REF. NOTES

1090



WINDOW WASHERS

WINDOW SQUEEGEES

TELESCOPIC POLES

BRILLIANT SYSTEM

EQUIPMENT FOR GLASS CLEANING

HAND DUSTERS

MANUAL CLOTHS

MONO-ROLL SYSTEM

TOP-CLEAN SYSTEM

Fil hand duster

FIL - acrylic hand duster in polybag



REF.	NOTES
2012	

Accessories hand dusters

End cone with Italian thread for telescopic handles and 3-hole aluminum handles \varnothing 23 mm



REF.	NOTES
P179040A	

End cone with Italian thread for telescopic handles and poles with Uni-Connect system



REF.	NOTES
P179047UA	for handles \varnothing 23 mm
P179049UA	for poles \varnothing 21 mm

Learn more about Uni-Connect in the glass and surfaces section

Set 6 pcs adapter with American thread for hand dusters and cobweb brushes



REF.	NOTES
0000SM00038U	



WINDOW WASHERS

WINDOW SQUEEGEES

TELESCOPIC POLES

BRILLIANT SYSTEM

EQUIPMENT FOR GLASS CLEANING

HAND DUSTERS

MANUAL CLOTHS

MONO-ROLL SYSTEM

TOP-CLEAN SYSTEM

Each surface has specific qualities and features that could be irreparably damaged, if cleaned with unsuitable cloths.

This is the reason why Filmop has designed and carried out its **TOUCH** line of cloths and sponges: top quality products for the cleaning of environments, from the floor to the most delicate surfaces, that ensure the best results in the shortest time and with the minimum effort.

TOUCH products are divided according to their cleaning features, differing between **Multipurpose** and **Specials**.

The special range includes **EU Ecolabel certified cloths**, a guarantee of sustainability throughout the entire life cycle.

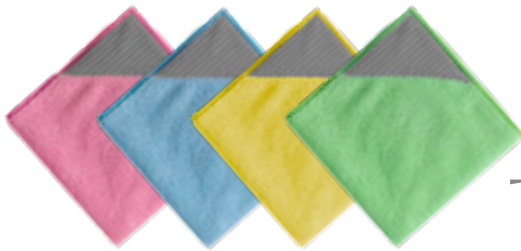

Touch



Multipurpose

Cloths to use dry for a quick and daily cleaning; if damped with water or detergents, they are advised for a deeper and more professional dusting.

Specials

Cloths meant for specific cleaning operations, they clean effectively without leaving marks and help the quick drying of surfaces if used wet.

Washing temperatures:



: Multi-T, Multi-T Maxi, Multi-T Light, Dual-T, Silky-T, Multi-T antibatterico, Steel-T, Power-T, Glazy-T, Eco Multi-T



: Free-T, Slide-T, Cristal-T, Glass-T, Basic-T, Fast-T, Profi-T

COLOR CODE

The colour of cloths represents a shared colour-coding that identifies the area to be cleaned and how to be used, avoiding the transmission of dirt and bacteria from one cleaned surface to another one, reducing any risk of cross-contamination.

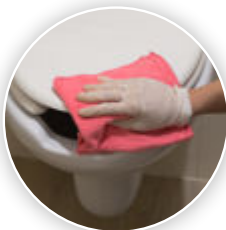

Red cloth: very high risk
For the cleaning of bidets, WC



Yellow cloth: high risk
Cleaning of washbasins, tiles and mirrors in bathrooms



Green cloth: medium risk
Cleaning in kitchens, canteens and bars



Blue cloth: low risk
For the cleaning of all surfaces, such as tables, writing desks, wardrobes, glasses

Power-T: multipurpose cloths, ideal for any surface

The Power-T cloth quickly cleans **any kind of surface**: made of non woven ultra-microfiber, **exerts a degreasing and polishing action**.

Resistant and long lasting, ideal for **dry and wet dust mopping**.



- BRIGHT CLEAN
- HIGH ABSORBENCY
- BEST SLIDING
- LONG LASTING PERFORMANCE

Glazy-T: special cloth for glass and windows

The Glazy-T cloth is the ideal solution for **glass and windows**: made of non woven ultra-microfiber, **it ensures an effective cleaning and leaves no streaks**.

It offers high performances both in **wet and dry use and excellent resistance to washing**.



WINDOW WASHERS

WINDOW SQUEEGEES

TELESCOPIC POLES

BRILLIANT SYSTEM

EQUIPMENT FOR GLASS CLEANING

HAND DUSTERS

MANUAL CLOTHS

MONO-ROLL SYSTEM

TOP-CLEAN SYSTEM

Multipurpose cloths

POWER-T - non-woven ultra-microfiber cloth



REF.	NOTES	NET WEIGHT (kg)	SIZE (cm) ↓ ↓ ↓
TCH201010		0,022	40x40
TCH201020		0,022	40x40
TCH201030		0,022	40x40
TCH201040		0,022	40x40
TCH201019	pck.: 20 polybags with 5 pcs	2,2	40x40
TCH201029	pck.: 20 polybags with 5 pcs	2,2	40x40
TCH201039	pck.: 20 polybags with 5 pcs	2,2	40x40
TCH201049	pck.: 20 polybags with 5 pcs	2,2	40x40

Cloth for all surfaces - Degreasing and polishing effect - Weight 130 gr/sqm

DUAL-T - ultra-microfiber multipurpose cloth with scrubbing edge



REF.	NOTES	NET WEIGHT (kg)	SIZE (cm) ↓ ↓ ↓
TCH104010		0,04	40x40
TCH104020		0,04	40x40
TCH104030		0,04	40x40
TCH104040		0,04	40x40
TCH104019	pck.: 40 polybags with 5 pcs	8,03	40x40
TCH104029	pck.: 40 polybags with 5 pcs	8,03	40x40
TCH104039	pck.: 40 polybags with 5 pcs	8,03	40x40
TCH104049	pck.: 40 polybags with 5 pcs	8,03	40x40

Cloth for any surface and for very dirty environments - Ideal to remove any marks and sediment deposit - Weight 250 gr/mq

ECO MULTI-T - multipurpose ultra-microfibre cloth



REF.	NOTES	NET WEIGHT (kg)	SIZE (cm) ↓ ↓ ↓
TCE101010		0,042	40x40
TCE101020		0,042	40x40
TCE101030		0,042	40x40
TCE101040		0,042	40x40
TCE101019	pck.: 40 polybags with 5 pcs	8,44	40x40
TCE101029	pck.: 40 polybags with 5 pcs	8,4	40x40
TCE101039	pck.: 40 polybags with 5 pcs	8,44	40x40
TCE101049	pck.: 40 polybags with 5 pcs	8,44	40x40

Cloth for any surface and for very dirty environments - Resistant, it removes and keeps dirt - Weight 250 gr/sqm

MULTI-T - ultra-microfiber multipurpose cloth



REF.	NOTES	NET WEIGHT (kg)	SIZE (cm) ↓ ↓ ↓
TCH101010		0,042	40x40
TCH101020		0,042	40x40
TCH101030		0,042	40x40
TCH101040		0,042	40x40
TCH101019	pck.: 40 polybags with 5 pcs	8,44	40x40
TCH101029	pck.: 40 polybags with 5 pcs	8,4	40x40
TCH101039	pck.: 40 polybags with 5 pcs	8,44	40x40
TCH101049	pck.: 40 polybags with 5 pcs	8,44	40x40

Cloth for any surface and for very dirty environments - Resistant, it removes and keeps dirt - Weight 250 gr/sqm

MULTI-T LIGHT - ultra-microfiber multipurpose cloth



REF.	NOTES	NET WEIGHT (kg)	SIZE (cm) ↓ ↓ ↓
TCH101510		0,03	38x38
TCH101520		0,03	38x38
TCH101530		0,03	38x38
TCH101540		0,03	38x38
TCH101519	pck.: 10 polybags with 20 pcs	6,064	38x38
TCH101529	pck.: 10 polybags with 20 pcs	6,064	38x38
TCH101539	pck.: 10 polybags with 20 pcs	6,064	38x38
TCH101549	pck.: 10 polybags with 20 pcs	6,064	38x38

Cloth for any surface and for very dirty environments - Resistant, it removes and keeps dirt - Weight 220 gr/sqm

MULTI-T A-B PLUS - anti-bacterial ultra-microfiber multipurpose cloth



REF.	NOTES	NET WEIGHT (kg)	SIZE (cm) ↓ ↓ ↓
TCH101410		0,056	40x40
TCH101420		0,056	40x40
TCH101430		0,056	40x40
TCH101440		0,056	40x40
TCH101419	pck.: 40 polybags with 5 pcs	11,2	40x40
TCH101429	pck.: 40 polybags with 5 pcs	11,2	40x40
TCH101439	pck.: 40 polybags with 5 pcs	11,2	40x40
TCH101449	pck.: 40 polybags with 5 pcs	11,2	40x40

With anti-bacterial treatment, it removes up to 99,98% of bacteria and fungi - Cloth for any surface and for very dirty environments - Resistant, it removes and keeps dirt - Weight 310 gr/mq



WINDOW WASHERS

WINDOW SQUEEGEES

TELESCOPIC POLES

BRILLIANT SYSTEM

EQUIPMENT FOR GLASS CLEANING

HAND DUSTERS

MANUAL CLOTHS

MONO-ROLL SYSTEM

TOP-CLEAN SYSTEM

SILKY-T - ultra-microfiber multipurpose cloth



REF.	NOTES	NET WEIGHT (kg)	SIZE (cm) ↓ ↓ ↓
TCH101210		0,024	30x40
TCH101220		0,024	30x40
TCH101230		0,024	30x40
TCH101240		0,024	30x40
TCH101219	pck.: 48 polybags with 5 pcs	5,76	30x40
TCH101229	pck.: 48 polybags with 5 pcs	5,76	30x40
TCH101239	pck.: 48 polybags with 5 pcs	5,76	30x40
TCH101249	pck.: 48 polybags with 5 pcs	5,76	30x40

Cloth for all surfaces - Resistant, it removes and keeps dirt, lint and smear free - Weight 190 gr/mq

FREE-T - Thermobounded non-woven multipurposes cloth



REF.	NOTES	NET WEIGHT (kg)	SIZE (cm) ↓ ↓ ↓
TCH601010		0,022	38x40
TCH601020		0,017	38x40
TCH601030		0,022	38x40
TCH601040		0,022	38x40
TCH601019	pck.: 20 polybags with 10 pcs	4,4	38x40
TCH601029	pck.: 20 polybags with 10 pcs	3,5	38x40
TCH601039	pck.: 20 polybags with 10 pcs	4,4	38x40
TCH601049	pck.: 20 polybags with 10 pcs	4,4	38x40

Cloth ideal to dust any surface - Half-disposable, cheap Weight 130 gr/sqm

Special cloths

STEEL-T - coagulated textile wiping cloth



REF.	NOTES	NET WEIGHT (kg)	SIZE (cm) ↓ ↓ ↓
TCH401010		0,046	38x38
TCH401020		0,046	38x38
TCH401030		0,046	38x38
TCH401040		0,046	38x38
TCH401019	pck.: 20 polybags with 5 pcs	4,958	38x38
TCH401029	pck.: 20 polybags with 5 pcs	4,958	38x38
TCH401039	pck.: 20 polybags with 5 pcs	4,958	38x38
TCH401049	pck.: 20 polybags with 5 pcs	4,958	38x38

Cloth for glossy surfaces, chromed steel, ceramics - Polishes and removed limescale - Degreasing - Weight 285 gr/mq

GLAZY-T - non-woven ultra-microfiber cloth



REF.	NOTES	NET WEIGHT (kg)	SIZE (cm) ↓ ↓ ↓
TCH201120		0,028	40x50
TCH201129	pck.: 20 polybags with 5 pcs	2,8	40x50

Ideal for glass, windows and dishes. - It cleans without leaving marks - Weight 130 gr/sqm

GLASS-T - ultra-microfiber wiping cloth



REF.	NOTES	NET WEIGHT (kg)	SIZE (cm) ↓ ↓ ↓
TCH103020		0,029	40x40
TCH103029	pck.: 40 polybags with 5 pcs	5,8	40x40

Cloth for glossy surfaces - It wipes without smearing - Ideal for glasses - Weight: 180 gr/Sq m

CRISTAL-T - perforated wiping cloth

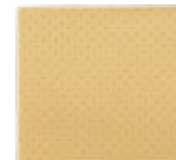

REF.	NOTES	NET WEIGHT (kg)	SIZE (cm) ↓ ↓ ↓
TCH404030		0,031	38x40
TCH404039	pck.: 10 polybags with 10 pcs	3,15	38x40

Cloth for glossy surfaces - It wipes without smearing - Ideal for car cleaning - Weight: 180 gr/Sq m



WINDOW WASHERS

WINDOW SQUEEGEES

TELESCOPIC POLES

BRILLIANT SYSTEM

EQUIPMENT FOR GLASS CLEANING

HAND DUSTERS

MANUAL CLOTHS

MONO-ROLL SYSTEM

TOP-CLEAN SYSTEM

SLIDE-T - resin coated wiping cloth



REF.	NOTES	NET WEIGHT (kg)	SIZE (cm)
TCH602030		0,024	40x45
TCH602039	pck.: 20 polybags with 10 pcs	4,8	40x45

Cloth ideal for any surface - Smooth-running and bleach resistant - Weight 160 gr/sqm

PROFI-T - non-woven ultra-microfiber cloth



REF.	NOTES	NET WEIGHT (kg)	SIZE (cm)
TCH102020		0,02	38x40
TCH102029	pck.: 20 polybags with 5 pcs	2	38x40

Cloth for windows, glasses and delicate surfaces. - Smooth-running and degreasing - Weight 100 gr/sqm

MULTI-T MAXI - ultra-microfiber multipurpose cloth



REF.	NOTES	NET WEIGHT (kg)	SIZE (cm)
TCH101120		0,08	50x60
TCH101129	pck.: 40 polybags with 5 pcs	16,08	50x60

Cloth for any surface and for very dirty environments - Resistant, soft and big size, it removes and keeps dirt - Weight 250 gr/sqm

BASIC-T - resin coated cloth for floor washing



REF.	NOTES	NET WEIGHT (kg)	SIZE (cm)
TCH603040		0,042	40x50
TCH603049	pck.: 20 polybags with 10 pcs	8,4	40x50

Cloth for smooth and delicate floors - Resistant and smooth-running - Weight 210 gr/sqm

FAST-T - microfiber cloth for floor washing



REF.	NOTES	NET WEIGHT (kg)	SIZE (cm)
TCH120020		0,061	60x40
TCH120029	pck.: 40 polybags with 5 pcs	12,2	60x40

Cloth for smooth and delicate floors - Resistant and smooth-running, it removes and keeps dirt - Weight 250 gr/sqm

INTENSIVE-T - sponge with ultra-abrasive scourer

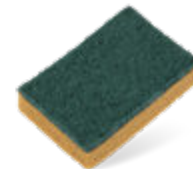

REF.	NOTES	NET WEIGHT (kg)	SIZE (cm)
TCH803000		0,018	14x9,5x3,5
TCH803009	pck.: 10 polybags with 10 pcs	1,8	14x9,5x3,5

Sponge for any environment - Degreasing

Multipurpose sponge



REF.	NOTES	SIZE (cm)
9111		12x29x6,5

Sponge for any environment

Multipurpose sponge with abrasive fibres

NEW



REF.	NOTES	NET WEIGHT (kg)	SIZE (cm)
9211		0,016	15,3x6,9x4,2



WINDOW WASHERS

WINDOW SQUEEGEES

TELESCOPIC POLES

BRILLIANT SYSTEM

EQUIPMENT FOR GLASS CLEANING

HAND DUSTERS

MANUAL CLOTHS

MONO-ROLL SYSTEM

TOP-CLEAN SYSTEM

Gloves

Ultra-microfiber mitten for dusting/washing, with color-coded tags

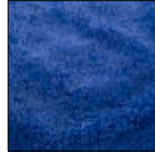

REF.	NOTES	SIZE (cm) ↓ ↓ ↓
8593	Packed into polybags with 5 pcs each	14x26

Weight: 370 gr/mq

Ultra-microfiber mitten for glasses, with color-coded tags



REF.	NOTES	SIZE (cm) ↓ ↓ ↓
8594	Packed into polybags with 5 pcs each	14x26

Weight: 300 gr/mq



WINDOW WASHERS

WINDOW SQUEEGEES

TELESCOPIC POLES

BRILLIANT SYSTEM

EQUIPMENT FOR GLASS CLEANING

HAND DUSTERS

MANUAL CLOTHS

MONO-ROLL SYSTEM

TOP-CLEAN SYSTEM

Mono-Roll disposable cloth

Mono-Roll is a **disposable TNT cloth with perforated weave** characterized by its high absorbency capacity and a uniform release of the cleaning solution on the surface.

- Removes and traps dirt
- Suitable for use with disinfectants
- Excellent also for dry cleaning
- Manual use or combined with dusting mop holders for high surfaces



PATENTED SYSTEM

The roll can be soaked in a **plastic bucket 4L**, following a few simple steps.

- Hermetic cover with an exclusive and fast cloth extraction system
- Practical and handy, it can be used alone or with Alpha trolleys

■ Mono-Roll

MONO-ROLL - manual disposable cloth in TNT



REF.	NOTES	SIZE (cm) ↓ ↓ ↓
00PU0203000	pck.: 6 rolls with 90 tears each	32x28

4 lt plastic bucket with handle and hermetic cover with central slot for cloth extraction



REF.	NOTES	SIZE (cm) ↓ ↓ ↓
0000SE3104A		17x25,5x25
0000SE3104B		17x25,5x25
0000SE3104C		17x25,5x25
0000SE3104F		17x25,5x25

Plastic mop holder with grip with Italian thread for SPILLO hand duster

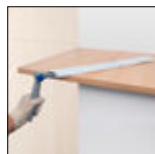

REF.	NOTES	SIZE (cm) ↓ ↓ ↓
2460U		40
2660U		60

Suitable for use with QUIK-STIK disposable cloths

Graduated plastic jar



REF.	NOTES
P191000T	3lt
P192000T	0,5L



WINDOW WASHERS

WINDOW SQUEEGEES

TELESCOPIC POLES

BRILLIANT SYSTEM

EQUIPMENT FOR GLASS CLEANING

HAND DUSTERS

MANUAL CLOTHS

MONO-ROLL SYSTEM

TOP-CLEAN SYSTEM



Surface cleaning with pre-soaking system

Top-Clean is a cleaning system especially advised for the cleaning of desks, table-tops, tables, blackboards and walls in classrooms, schools, canteens, self-services, bars, restaurants and hotels.

This mop holder combined with a traditional mop covers a wider working area than the one covered by the operator's hand using a simple cloth, thus saving time during cleaning operations; it is ergonomic and handy thanks to its grip.



YouTube

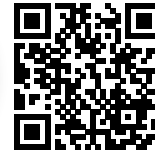

GLASS AND SURFACE CLEANING LINE

Top-Clean holder and mops

TOP-CLEAN - plastic mop holder with grip and strips 2,5 cm for strap tape system



RAPIDO SUPER EXTRA - high-performing white microfiber mop, looped yarn, with colored backing for strap tape system



REF.	NOTES	SIZE (cm) ↓ ↓ ↓
5233U		30
5234U		40

Mop holder used with Brilliant system for cleaning interior glass, mirrors and all smooth vertical surfaces and with Top Clean system for cleaning tables in cafeterias, bars, kitchens, restaurants...

REF.	NOTES	SIZE (cm) ↓ ↓ ↓
00PN0323A00DA	■	30x10
00PN0423A00DA	■	40x10
00PN0423A00DB	■	40x10
00PN0423A00DC	■	40x10
00PN0423A00DF	■	40x10
00PN0623A00DA	■	60x10

Ideal for industrial floors, natural stones, single-fired tiles and stoneware with a medium-high degree of dirt



WINDOW WASHERS

WINDOW SQUEEGEES

TELESCOPIC POLES

BRILLIANT SYSTEM

EQUIPMENT FOR GLASS CLEANING

HAND DUSTERS

MANUAL CLOTHS

MONO-ROLL SYSTEM

TOP-CLEAN SYSTEM

RAPIDO SUPER - high-performing white microfiber mop, looped yarn, with colored backing for strap tape system



REF.	NOTES	SIZE (cm)
00PN0309A00DA		30x10
00PN0309A00DB		30x10
00PN0309A00DC		30x10
00PN0309A00DF		30x10
00PN0409A00DA		40x10
00PN0409A00DB		40x10
00PN0409A00DC		40x10
00PN0409A00DF		40x10
00PN0609A00DA		60x10
00PN0609A00DB		60x10
00PN0609A00DC		60x10
00PN0609A00DF		60x10

Ideal for any surface with medium-high dirt

RAPIDO - colored microfiber mop, looped yarn, with colored backing for strap tape system



REF.	NOTES	SIZE (cm)
0000214AA		40x10
0000214BB		40x10
0000214CC		40x10
0000214FF		40x10

Ideal for industrial floors, natural stones, single-fired tiles and stoneware with a medium-high degree of dirt

PULI-SCRUB - ultra-microfiber and polypropylene mop with strap tape system and colour-coded tag

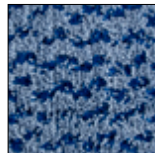
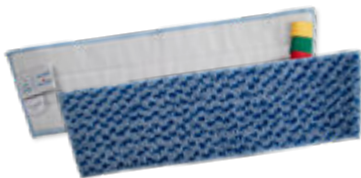

REF.	NOTES	SIZE (cm)
000EPN02011		30
000EPN03011		40
000EPN03021		60

Ideal for scrubbing and wet mopping of non-slip floors and natural terracotta with medium degree of stubborn dirt

MICRO-ACTIVA - ultra-microfiber mop, polyester backing, with strap tape system and colour-coded tag

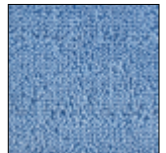

REF.	NOTES	SIZE (cm)
000EPN02012		30
000EPN03012		40
000EPN03022		60

Ideal for industrial floors, single-fired tiles, stoneware and woods with a medium degree of dirt

Handles and safety signs



Handles

Warning safety signs





HANDLES

WARNING SAFETY SIGNS

ErgoSwing ergonomic system

HIGH PERFORMANCES, NO EFFORT

ErgoSwing is the innovative system consisting of telescopic handle with turning grip and mop holder with ergonomic joint designed for **easy S movement**.

The system guarantees **less strain** and **increased productivity**, together with better floor cleaning performance.

- **ERGONOMIC:** 360° rotation hand grips for easier movement and sturdy grip
- **SAFE:** the rotation locking mechanism allows to safely place the tool
- **EFFICIENT:** the system offers optimum performance, with significantly less effort required by the operator
- **INTUITIVE:** it features a simple and clear design that makes it particularly easy to use
- **COMFORTABLE:** comfortable and pleasant to use, it ensures the psycho-physical well-being of the operator
- **TELESCOPIC:** the adjustment of the length of the telescopic handle up to the chin helps a correct posture during cleaning operations.



HANDLES AND SAFETY SIGNS

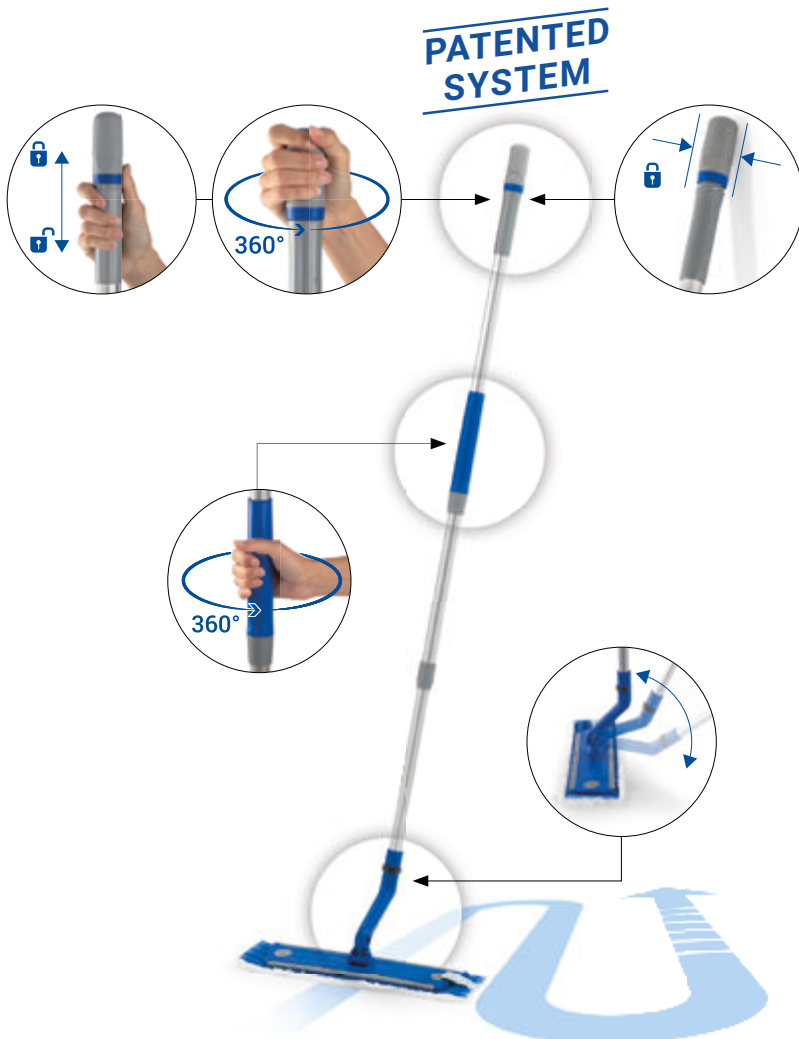

The rotation mechanism of the upper handle can be locked in order to place the tool safely.



ErgoSwing easily cleans even the most difficult to reach places.



HANDLES

WARNING SAFETY SIGNS



CORRECT POSTURE

Continuous improper posture is one of the main risk factors in the appearance of disorders and pathologies affecting the musculoskeletal system over time.

ErgoSwing is designed to **ensure the maintenance of correct posture** while cleaning floors:

- the neck and the trunk remain in a symmetrical position
- the arms do not assume uncomfortable positions
- the shoulders are not forced to elevate
- the elbows are not subjected to extreme flexing or extension
- the forearms are not required to rotate in an extreme manner
- the knees and ankles remain in a neutral position

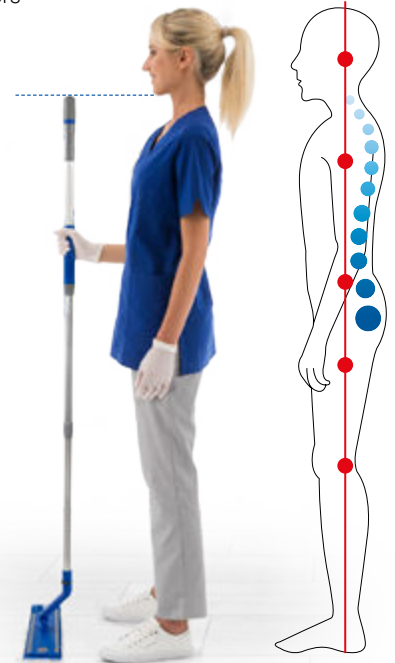

EFFORTLESS

The use analysis found that **the effort made by operators while using ErgoSwing is significantly lower** than that of standard systems.

The notable reduction in effort leads to less fatigue and an increase in operator well-being, resulting in **higher productivity**.

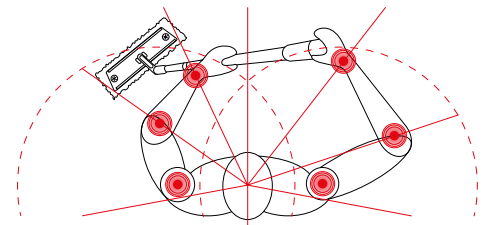

PROVEN ERGONOMICS

In the long term, repeated wrist strain can cause muscle-skeletal issues and pathologies. The ErgoSwing system use analysis conducted by Humana Consulting demonstrates a **significant reduction in wrist bending and extension** when compared with traditional systems: ErgoSwing allows the user to significantly remain below the maximum tolerance area (45°), **preventing the onset of work-related illnesses**.

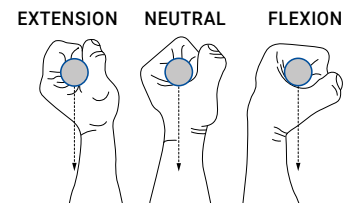

WRIST MOVEMENT WITH THE ERGOSWING

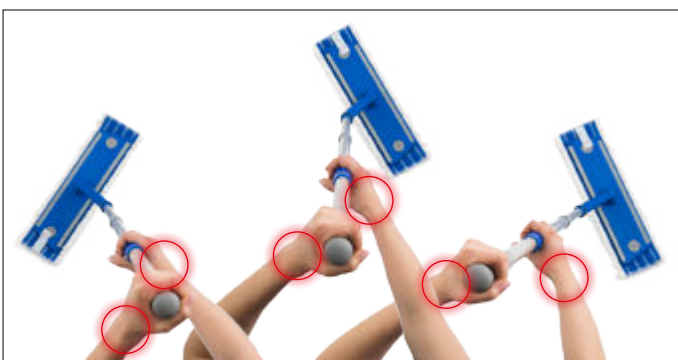

ErgoSwing limits wrist movement, thus **reducing effort**

WRIST MOVEMENT WITH STANDARD SYSTEMS

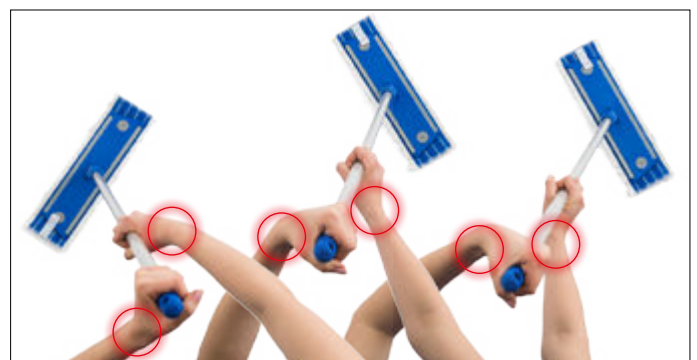

Standard systems force the wrist to fully extend



HANDLES

WARNING SAFETY SIGNS

Aluminium telescopic handles

2-piece anodized aluminium telescopic handle for ErgoSwing system with turning grips and coloured insert

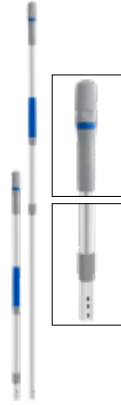

REF.	NOTES	SIZE (cm)
		↓ ↓ ↓
0000AM3045A	blue, with blue insert	184
0000AM3045UU	grey, with grey insert	184
0000AM3045UA	grey, with blue insert	184
0000AM3045UB	grey, with red insert	184
0000AM3045UC	grey, with yellow insert	184
0000AM3045UF	grey, with green insert	184
Extends from 106 to 184 cm - External tube ø 26 mm, internal tube ø 23 mm		

2-piece anodized aluminium telescopic handle with ergonomic grip and coloured cap

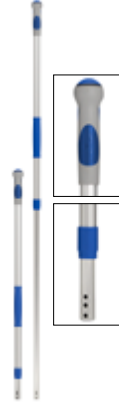

REF.	NOTES	SIZE (cm)
		↓ ↓ ↓
0000AM3070A	blue, with blue cap	184
0000AM3070UU	grey, with grey cap	184
0000AM3070UA	grey, with blue cap	184
0000AM3070UB	grey, with red cap	184
0000AM3070UC	grey, with yellow cap	184
0000AM3070UF	grey, with green cap	184
0000AM3090A	blue, with blue cap	93
Art. 0000AM3070 extendable from 102 to 184 cm - Art. 0000AM3090A extendable from 56 to 93 cm - External tube ø 26 mm, internal tube ø 23 mm		

Anodized aluminium telescopic handle in 2 pcs with ergonomic grip, blue cap and end cone with Italian thread

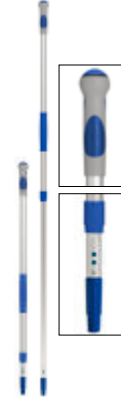

REF.	NOTES	SIZE (cm)
		↓ ↓ ↓
0000AM3170A	blue, with blue cap	184
Extendible form 102 to 184 cm - External tube ø 26 mm, internal tube ø 23 mm		

Anodized aluminium telescopic handle with anti-bacterial components - 2 pcs

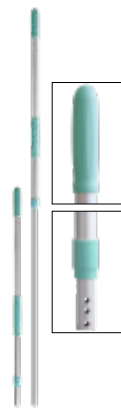

REF.	NOTES	SIZE (cm)
		↓ ↓ ↓
0000AM3040FZ		182
Extendible from 100 to 182 cm - External tube ø 26 mm, internal tube ø 23 mm		

2-piece telescopic anodized aluminium handle

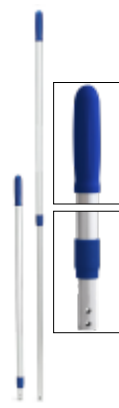

REF.	NOTES	SIZE (cm)
		↓ ↓ ↓
0000AM3060A		140
Extends from 79 to 140 cm - External tube ø 26 mm, internal tube ø 23 mm		

Accessories for handles

End cone with Italian thread for telescopic handles and 3-hole aluminum handles ø 23 mm



REF.	NOTES
P179040A	

End cone with Italian thread for telescopic handles and poles with Uni-Connect system



REF.	NOTES
P179047UA	for handles ø 23 mm
P179049UA	for poles ø 21 mm

Learn more about Uni-Connect in the glass and surfaces section



HANDLES

WARNING SAFETY SIGNS

Wooden handles

Varnished wooden handle \varnothing 24 mm with Italian screw and hole

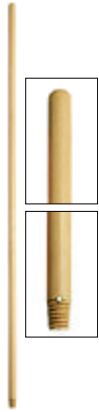

REF.	NOTES	SIZE (cm)
0000LM30023		130
0000LM30003		150

Thanks to their hole and screw, these handles can be used both with mop holders with screw and with the ones with ring

Wooden handle



REF.	NOTES	SIZE (cm)
1057	\varnothing 24 mm for industrial brooms	140
1070	\varnothing 30 mm with hole for Street brooms	145

Chromed metal handles

Chromed metal handle with hole \varnothing 22 mm - 2 pcs



REF.	NOTES	SIZE (cm)
1053A		140
1054		130

Aluminium handles

Anodized aluminium handle \varnothing 23 mm with 3 holes, coloured grip

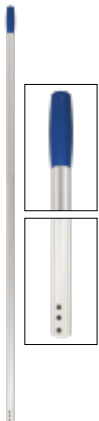

REF.	NOTES	SIZE (cm)
0000AM30025		130
0000AM30015		140
0000AM30015B		140
0000AM30015C		140
0000AM30015F		140
0000AM30015U		140
0000AM30005		150

The 3 holes allow the use of the handle with several and different mop holders

Anodized aluminium handle \varnothing 22 mm, with plastic Italian thread

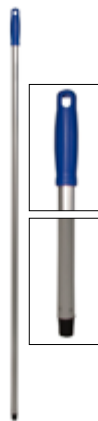

REF.	NOTES	SIZE (cm)
0000AM30010		140
0000AM30020		130

Upon request, it is available with coloured grip

Glass fiber handles

Glass fiber handle \varnothing 23,5 mm with hole

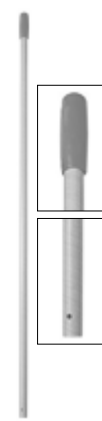

REF.	NOTES	SIZE (cm)
1069E		145



HANDLES

WARNING SAFETY SIGNS

Coated metal handles

Plastic coated metal handles

Varnished iron handle \varnothing 22 mm with Italian thread

Coated iron handle \varnothing 24 mm, 4 pieces, with Italian thread

Plastic coated telescopic metal handle \varnothing 22 mm with Italian thread, cone - 2 pcs

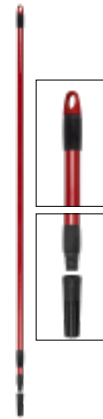
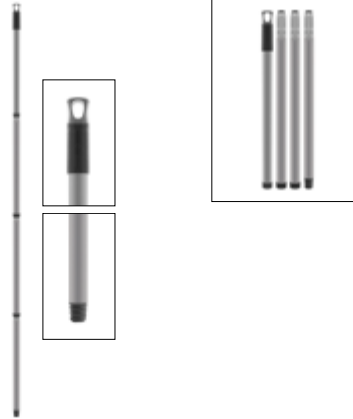
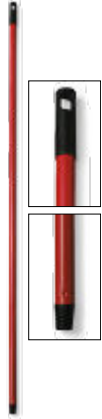

REF.	NOTES	SIZE (cm) ↓ ↓ ↓
1059		130

REF.	NOTES	SIZE (cm) ↓ ↓ ↓
1065		140

REF.	NOTES	SIZE (cm) ↓ ↓ ↓
2015		300



HANDLES

WARNING SAFETY SIGNS

Drop: tank handle

Thanks to Drop floor wet mopping is **easy**, **quick** and **efficient**:

- **Cleans** and **sanitises** every surface **in an instant**
- Lightweight, handy and **easy to use**
- **Prevents spillage** of cleaning solution



PATENTED SYSTEM



SMART DESIGN



Its tank has a 500 ml capacity and can be easily filled by means of a specific jug



The practical flap with rubber gasket assures an airtight seal



The ring, with a patent pending closing system of the tank, prevents from accidental spillage



The dispensing of the cleaning solution is activated by means of the button, which can be locked manually to prevent spillage



The three nozzles allow the cleaning solution to exit directly onto the surface to clean



It is possible to clean easily also the most difficult to reach areas thanks to its compact size

ErgoDrop: ergonomic tank handle

ErgoDrop combines the advantages of the professional Drop system with those of the innovative ergonomic ErgoSwing system, ensuring **maximum results with minimum effort**.

- Designed to **safeguard the operator's health**
- **It makes cleaning easier**, considerably reducing efforts
- **It assures high performances** and increases productivity





HANDLES

WARNING SAFETY SIGNS

Handles with tank

DROP - tank handle 500 ml



ERGODROP - tank handle 500 ml with turning grips for ErgoSwing system

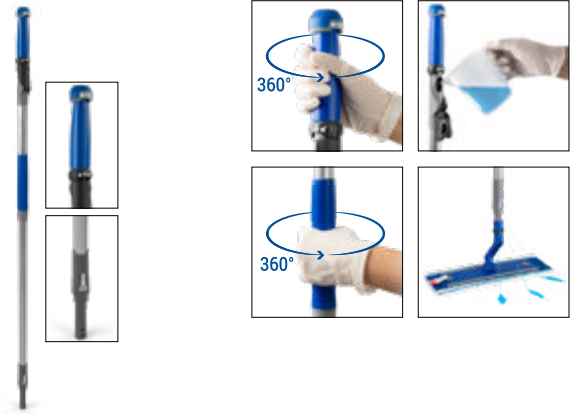

REF.	NOTES	SIZE (cm) ↓ ↓ ↓
0000TD0600A		142

The handle fits mop holders with traditional and Uni-Connect fitting

REF.	NOTES	SIZE (cm) ↓ ↓ ↓
0000TD0500A		142



HANDLES

WARNING SAFETY SIGNS

Safety signs - 2 parts and 3 parts

Monolingual plastic safety sign
"caution wet floor", 2 parts



REF.	NOTES	SIZE (cm) ↓ ↓ ↓
60068614	Without writing and without graphic symbol	42x23x57
8614.0	Without writing but with graphic symbol	42x23x57
8614	in Italian "ATTENZIONE PAVIMENTO BAGNATO"	42x23x57
8614GB	in English "CAUTION WET FLOOR"	42x23x57
8614D	in German "ACHTUNG RUTSCHGEFAHR"	42x23x57
8614F	in French "ATTENTION SOL GLISSANT"	42x23x57

On request available in other languages or in bilingual version (with one different language on every side)

Monolingual plastic safety sign
"caution wet floor", 3 parts



REF.	NOTES	SIZE (cm) ↓ ↓ ↓
60068624	Without writing and without graphic symbol	42x23x104
8624.0	Without writing but with graphic symbol	42x23x104
8624	in Italian "ATTENZIONE PAVIMENTO BAGNATO"	42x23x104
8624GB	in English "CAUTION WET FLOOR"	42x23x104
8624D	in German "ACHTUNG RUTSCHGEFAHR"	42x23x104
8624F	in French "ATTENTION SOL GLISSANT"	42x23x104

On request available in other languages or in bilingual version (with one different language on every side)

Monolingual plastic safety sign
"caution wet floor", 3 parts with check-list holder



REF.	NOTES	SIZE (cm) ↓ ↓ ↓
60068654	Without writing and without graphic symbol	42x23x104
8654.0	Without writing but with graphic symbol	42x23x104
8654	in Italian "PAVIMENTO BAGNATO"	42x23x104
8654GB	in English "WET FLOOR"	42x23x104
8654D	in German "ACHTUNG RUTSCHGEFAHR"	42x23x104
8654F	in French "SOL GLISSANT"	42x23x104

On request available in other languages or in bilingual version (with one different language on every side)

Conical safety sign

Conical plastic safety sign



REF.	NOTES	SIZE (cm) ↓ ↓ ↓
8634	h 93 cm	93

Weight 0,5 kgs for conical safety sign with screws



REF.	NOTES
V250004H	

Accessories for safety signs

Plastic chain for safety sign composed of 12 elements



REF.	NOTES
P250001C	length 1 mt

Red flashing light for conical safety sign



REF.	NOTES
P250002	battery power: 2 batteries 1,5V necessary



HANDLES

Round plastic board for conical safety sign



REF.	NOTES	
P230002A	"directional arrow"	
P230003C	in Italian "ATTENZIONE PAVIMENTO BAGNATO"	
P230GB3C	in English "CAUTION WET FLOOR"	
P2300D3C	in German "ACHTUNG RUTSCHGEFAHR"	
P2300F3C	in French "ATTENTION SOL MOUILLE"	

WARNING SAFETY SIGNS

Rectangular plastic board for conical safety sign



REF.	NOTES	
P240001C	in Italian "ATTENZIONE PAVIMENTO BAGNATO"	
P240GB1C	in English "CAUTION WET FLOOR"	
P2400D1C	in German "ACHTUNG RUTSCHGEFAHR"	
P240002C	in Italian "PULIZIA IN CORSO"	
P240GB2C	in English "CLEANING IN PROGRESS"	
P2400D2C	in German "REINIGUNGBARBAITEN"	
P240003C	in Italian "FUORI SERVIZIO"	
P240GB3C	in English "OUT OF SERVICE"	
P2400D3C	in German "AUSSER BETRIEB"	
P2400F3C	in French "HORS SERVICE"	
P240004B	in Italian "CHIUSO"	
P240GB4B	in English "CLOSED"	
P2400D4B	in German "GESCHLOSSEN"	
P2400F4B	in French "FERME"	

HANDLES AND SAFETY SIGNS

Safety sign for door

Safety sign for door "Cleaning in progress" with suction caps



REF.	NOTES
9310	Can be extended from 77 to 134 cm - Can be applied by suction cups - Customizable PVC sheeting

Buckets and mop trolleys



Bucket/wringer combos

Plastic mop trolleys

Chromed and Rilsan coated trolleys

Wringers

Multi-purpose buckets

Top-Down® buckets

Other plastic buckets



Single buckets

PLUTO - plastic bucket 12 L with handle and sieve



REF.	NOTES	SIZE (cm) ↓ ↓ ↓
2070A		35x28x30
2070B		35x28x30
2070C		35x28x30
2070F		35x28x30

MASTER LUX - plastic bucket 16 L with handle and sieve



REF.	NOTES	SIZE (cm) ↓ ↓ ↓
2080A		36x27x35
2080B		36x27x35
2080C		36x27x35
2080F		36x27x35

GEMINI - plastic bucket 15 L with 2 compartments, 2 handles and sieve



REF.	NOTES	SIZE (cm) ↓ ↓ ↓
2060A		42x28x33
2060B		42x28x33

JUMPY - 30 L shockproof plastic single bucket



REF.	SIZE (cm) ↓ ↓ ↓
000SL2700C	47x40x93

BABY - shockproof plastic single bucket 25 L



REF.	SIZE (cm) ↓ ↓ ↓
7970CGB	46x41x80

KING - shockproof plastic single bucket 15 L



REF.	SIZE (cm) ↓ ↓ ↓
7940CGB	44x31x71
7940AGB	44x31x71



BUCKET/WRINGER COMBOS

PLASTIC MOP TROLLEYS

CHROMED AND RILSAN COATED TROLLEYS

WRINGERS

MULTI-PURPOSE BUCKETS

TOP-DOWN® BUCKETS

OTHER PLASTIC BUCKETS

TWICE

16 lt



PATENTED SYSTEM



14 lt



Functional and affordable

Twice is the double bucket with wringer for professional floor wet mopping, designed to guarantee the best service and profitability during cleaning operations. It has a total 30 L capacity and it is equipped **with two drain-plugs**; thanks to its two compartments, it separates clean solution from rinsing water.

The bucket can be piled up thanks to the plastic feet that can be easily unassembled saving transport and storing costs.



It fits all Filmop plastic wringers.



Two separate drain-plugs



Stackable

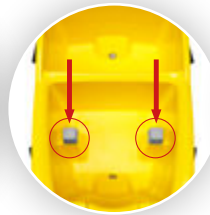

Specific wringer adaptor-plugs for Punto, Deep and Boost wringers



Wringer versions

TWICE - shockproof plastic bucket 30 L with two drain-plugs and Regular wringer



MAXI JOLLY - shockproof plastic single bucket 30 L with divider and drain-plug

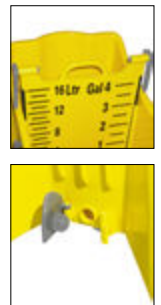

REF.	SIZE (cm)
0000SL2800C	60x40x93

REF.	SIZE (cm)
0000SL2601C	55x37x93

WRINGER VERSIONS

WRINGER	TROLLEY REF.
BOOST - flat wringer	0074SL2800C
PUNTO - roller wringer	0022SL2800C
DEEP - side press wringer without bottom	0006SL2800C

SPIDER - shockproof plastic single bucket 15 L with divider



SPIDER MAX - shockproof plastic single bucket 15 L with divider



REF.	SIZE (cm)
7930CGB	47x27x71

REF.	SIZE (cm)
7990CGB	55x27x87



BUCKET/WRINGER COMBOS |
 PLASTIC MOP TROLLEYS |
 CHROMED AND RILSAN COATED TROLLEYS |
 WRINGERS |
 MULTI-PURPOSE BUCKETS |
 TOP-DOWN® BUCKETS |
 OTHER PLASTIC BUCKETS

RO-CKET WHEELS - single plastic bucket 15 L with rubber rolls, divider and wheels

RO-CKET - single plastic bucket 15 L with rubber rolls and divider



REF.	NOTES	SIZE (cm) ↓ ↓ ↓
0000LP1402C		44x32x41

REF.	NOTES	SIZE (cm) ↓ ↓ ↓
0000LP1401C		44x32x35

Components for wringer buckets

Bucket with divider and wheels for 15 lt Spider bucket

15 lt bucket without divider and without wheels for Spider

Divider for Spider bucket



REF.	NOTES	SIZE (cm) ↓ ↓ ↓
7931CGBSS		40x28x34

REF.	NOTES
7932CGB	

REF.	NOTES
60152C	

Bucket 30 lt with wheels for Jumpy bucket

Bucket 25 lt with wheels for Baby bucket

Bucket 15 lt with wheels for King bucket



REF.	NOTES
00SSSL2700C	

REF.	NOTES
7971CGBSS	

REF.	NOTES	SIZE (cm) ↓ ↓ ↓
7941CGBSS		44x31x34,5

Bucket 16+14 lt with wheels and two drain-plugs for Twice bucket

Set of adaptor-plugs for wringer for Twice bucket

Valve for Twice bucket



REF.	NOTES
00SSSL2800C	

REF.	NOTES	
0000SM00030C	1B+2B - for wringer art. 7002	
0000SM00031U	1A+2A - for wringers art. 14000-12000-10000	
0000SM00032H	1C+2C - for wringer art. 8004	
0000SM00039U	for wringer code 7003	

REF.	NOTES
P190301H	

If it is used with wringers art. 7002, 14000 and 8004, you have to use the relative wringer adaptor-plugs

Buckets and mop trolleys



- BUCKET/WRINGER COMBOS
- PLASTIC MOP TROLLEYS
- CHROMED AND RILSAN COATED TROLLEYS
- WRINGERS
- MULTI-PURPOSE BUCKETS
- TOP-DOWN® BUCKETS
- OTHER PLASTIC BUCKETS

Bucket 30 Lt whit drain-plug, divider and wheels for Maxi Jolly bucket



REF.	NOTES
00SSSL2601C	

Divider with 2 lift levers and rubber profile for Maxi Jolly bucket



REF.	NOTES
P390300C	

Valve for Maxi Jolly bucket



REF.	NOTES
P190371H	

Plastic bucket 15 Lt with 2 compartments and 2 plastic handles for Gemini bucket



REF.	NOTES	SIZE (cm) ↓ ↓ ↓
2061A	■	42x28x27,5
2061B	■	42x28x27,5

Plastic sieve for Gemini bucket



REF.	NOTES
2062A	■
2062B	■

Plastic bucket 16 L with plastic handle for Master Lux bucket



REF.	NOTES	SIZE (cm) ↓ ↓ ↓
2051A	■	35x27,5x27,5
2051B	■	35x27,5x27,5
2051C	■	35x27,5x27,5
2051F	■	35x27,5x27,5

Plastic sieve for Master Lux bucket



REF.	NOTES	SIZE (cm) ↓ ↓ ↓
2082A	■	24x19x14
2082B	■	24x19x14
2082C	■	24x19x14
2082F	■	24x19x14

Plastic bucket 12 L with plastic handle for Pluto bucket



REF.	NOTES	SIZE (cm) ↓ ↓ ↓
2071A	■	35x28x23,5
2071B	■	35x28x23,5
2071C	■	35x28x23,5
2071F	■	35x28x23,5

Plastic sieve for Pluto bucket



REF.	NOTES
2072A	■
2072B	■
2072C	■
2072F	■

BUCKETS AND MOP TROLLEYS

Duo Pro System: double cleaning in half the time

Duo Pro System is a **professional wet mopping system** composed of a practical bucket with squeezing sieve, available with or without wheels according to the specific needs.

Designed for its use with the **Duo Face reversible mop holder** and **the range of double-faced mops**, it assures the highest efficiency and significant energy, time and cost savings.

- **It reduces strain:** designed to guarantee the highest ergonomics, comfort and simple use
- **It saves time:** thanks to the combined efficiency of mop holder, mop and wringer, the system ensures **double cleaning** with **half the wringing** when compared with traditional systems
- **It reduces waste:** the high level of washing autonomy of microfibre allows to use **significantly less detergent**, therefore also decreasing the impact on the environment



Suitable also as washing system combined with the Alpha trolley line

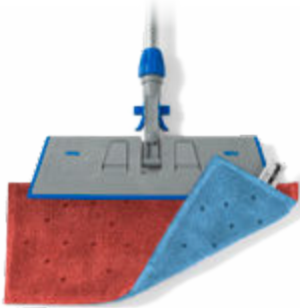

The reversible mop holder and the double-faced mops make cleaning easier: find out more in the Duo Face system section

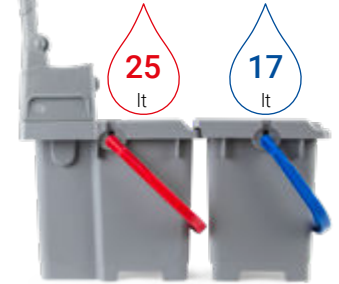

How to use it



Soak the mop in the cleaning solution



Insert the mop into the wringer



Lower the lever



Start mopping the floor



Rinse the mop

Duo Pro System

DUO PRO SYSTEM - 25l mop bucket with red handle complete with Duo Pro lever-operated wringer

DUO PRO - plastic lever-operated wringer for DuoFace system

Plastic 25l mop bucket for Duo Pro wringer



REF.	NOTES	SIZE (cm) ↓ ↓ ↓
0020SE1725UB	with castors	30,5x56x70,5
0020SE0725UB	without castors	30,5x56x63,5

REF.	NOTES	SIZE (cm) ↓ ↓ ↓
21040U		14,5x55x45

REF.	NOTES	SIZE (cm) ↓ ↓ ↓
0000SE0725UB	without castors	30,5x56x26
0000SE1725UB	with castors	30,5x56x33



BUCKET/WRINGER
COMBOS

PLASTIC MOP
TROLLEYS

CHROMED AND RILSAN
COATED TROLLEYS

WRINGERS

MULTI-PURPOSE
BUCKETS

TOP-DOWN® BUCKETS

OTHER PLASTIC
BUCKETS

Cleaning becomes easy

Easy Wash is a **compact and handy semi-professional system** designed to make cleaning extremely easy, convenient and fast thanks to the innovative design studied in every detail.

Composed of a touch-free mop holder, microfiber mop and bucket with wringer, it is particularly suitable for washing **horizontal and vertical surfaces** in small areas.



TOUCH FREE

PATENTED
SYSTEM

Easy WASH



YouTube



HIGH PERFORMANCE CLEANING MOP HOLDER AND MOP



- The exclusive **touch-free system** eliminates any hand contact with dirt, preventing the risk of cross-contamination
- The **mop fixing and release system** makes operations quicker and easier, avoiding repeated bending and consequent strain
- The special **micro flaps** are designed to keep the mop fixed to the mop holder, thus preventing accidental release during use
- The **Energy-Fur microfiber** is characterized by its high capillary absorbency, which ensures a great floor coverage and effectiveness in removing dirt

ERGONOMIC WRINGING BUCKET AND WRINGER

- The special **shape of the wringer** facilitates mop wringing
- Built-in **handle holder** allows you to conveniently attach the tool
- The practical **back handle** makes it easy to grip the bucket when emptying
- **Polypropylene** composition ensures high durability and long service life



Mop fixing



Energy-Fur

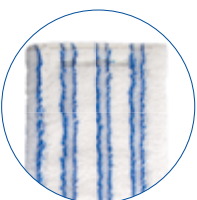

Mop releasing



Wringer shape

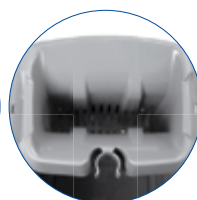

Handle holder

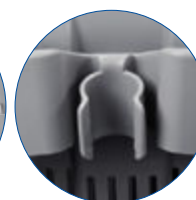

Back handle

BUCKET/WRINGER COMBOS

PLASTIC MOP TROLLEYS

CHROMED AND RILSAN COATED TROLLEYS

WRINGERS

MULTI-PURPOSE BUCKETS

TOP-DOWN® BUCKETS

OTHER PLASTIC BUCKETS

Kit **EASY WASH** - bucket 15L complete with sieve, mop holder and mop



Kit **EASY WASH** - bucket 15L complete with sieve, mop holder, mop and 4 pieces handle



REF.	NOTES	SIZE (cm)
0000SE2815UA	blue bucket handle and blue components of the mop holder	37x30x37,5
0000SE2815UB	red bucket handle and red mop holder screw	37x30x37,5
0000SE2815UC	yellow bucket handle and yellow mop holder screw	37x30x37,5
0000SE2815UF	green bucket handle and green mop holder screw	37x30x37,5
0000SE0815UA	Platic bucket 15L for Easy Wash, grey with blue handle	1 pc.
0000TP0011UA	EASY WASH - plastic mop holder with flaps	1 pc.
00PN0311N00	ENERGY-FUR - white microfibre mop with blue stripes and abrasive, polyester backing, flaps and colour-coded tags, 35 cm	1 pc.
21020U	Plastic sieve for Easy Wash	1 pc.

REF.	NOTES	SIZE (cm)
0000SE3815UA		37x30x37,5
0000SE0815UA	Platic bucket 15L for Easy Wash, grey with blue handle	1 pc.
0000TP0511U	EASY WASH MOP HOLDER - plastic mop holder with flaps and joint with Italian thread	1 pc.
00PN0311N00	ENERGY-FUR - white microfibre mop with blue stripes and abrasive, polyester backing, flaps and colour-coded tags, 35 cm	1 pc.
1065	Coated iron handle ø 24 mm 4 pieces with Italian thread, 140 cm	1 pc.
21020U	Plastic sieve for Easy Wash	1 pc.

EASY WASH - plastic bucket 15 L with handle and sieve



15 lt plastic sieve with plastic handle, for Easy Wash



Plastic sieve for Easy Wash



REF.	NOTES	SIZE (cm)
0000SE1815UA		37x30x37,5
0000SE1815UB		37x30x37,5
0000SE1815UC		37x30x37,5
0000SE1815UF		37x30x37,5

REF.	NOTES	SIZE (cm)
0000SE0815UA		37x30x27,5
0000SE0815UB		37x30x27,5
0000SE0815UC		37x30x27,5
0000SE0815UF		37x30x27,5

REF.	NOTES
21020U	

Buckets and mop trolleys



BUCKET/WRINGER COMBOS

PLASTIC MOP TROLLEYS

CHROMED AND RILSAN COATED TROLLEYS

WRINGERS

MULTI-PURPOSE BUCKETS

TOP-DOWN® BUCKETS

OTHER PLASTIC BUCKETS

EASY WASH MOP HOLDER - foldable plastic mop holder with flaps



REF.	NOTES	SIZE (cm)
0000TP0011UA	blue	35x10
0000TP0011UB	red	35x10
0000TP0011UC	yellow	35x10
0000TP0011UF	green	35x10

EASY WASH MOP HOLDER - foldable plastic mop holder with flaps, joint with Italian thread



REF.	NOTES	SIZE (cm)
0000TP0511U		35x10

ENERGY-FUR white microfiber mop with blue stripes and abrasive, TNT backing, with flaps for Easy Wash system and colour-coded tags

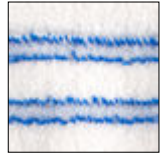

REF.	NOTES	SIZE (cm)
00PN0311N00		35x15

Ideal for all smooth flooring, medium degree of dirt

2-piece anodized aluminium telescopic handle with ergonomic grip and coloured cap

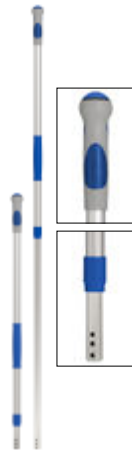

REF.	NOTES	SIZE (cm)
0000AM3070A	blue, with blue cap	184
0000AM3070UU	grey, with grey cap	184
0000AM3070UA	grey, with blue cap	184
0000AM3070UB	grey, with red cap	184
0000AM3070UC	grey, with yellow cap	184
0000AM3070UF	grey, with green cap	184
0000AM3090A	blue, with blue cap	93

Art. 0000AM3070 extendable from 102 to 184 cm - Art. 0000AM3090A extendable from 56 to 93 cm - External tube ø 26 mm, internal tube ø 23 mm

Coated iron handle ø 24 mm, 4 pieces, with Italian thread

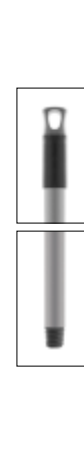

REF.	NOTES	SIZE (cm)
1065		140

BUCKETS AND MOP TROLLEYS

Tradition to design innovation

OneFred is an **innovative and compact wet mopping system**:

- Modern design, conceived for maximum ergonomics
- Designed to be light, compact and resistant at the same time
- It assures the maximum versatility: one frame for buckets 15L and 25L, simple and quick to assemble
- With innovative, handy and safe coupling system on Alpha trolleys



Compatible with Uni-Connect system



OneFred combined with **Boost** wringer is specifically for flat mopping systems



Commitment towards environmental sustainability



Filmop is certified with the **Carbon Footprint Systematic Approach**, carried out in accordance with UNI EN ISO 14067:2018, which allows quantifying the environmental impact of the product expressed in CO₂ emitted at each stage of the life cycle.

OneFred trolleys are partly made of plastic components certified **Plastic Second Life** according to the Green Public Procurements environmental policies.

Buckets and mop trolleys



BUCKET/WRINGER
COMBOS

**PLASTIC MOP
TROLLEYS**

CHROMED AND RILSAN
COATED TROLLEYS

WRINGERS

MULTI-PURPOSE
BUCKETS

TOP-DOWN® BUCKETS

OTHER PLASTIC
BUCKETS

OneFred trolleys

ONEFRED - plastic trolley with plastic grip, tray, broom holder and Boost wringer



REF.	CAPACITY (L)	SIZE (cm) ↓ ↓ ↓
0071LF0031YU	2x15	53x65x87
0071LF0051YU	2x25	53x73x87

ONEFRED - plastic trolley with plastic grip and Boost wringer



REF.	CAPACITY (L)	SIZE (cm) ↓ ↓ ↓
0071LF0030YU	2x15	39x65x87
0071LF0050YU	2x25	40x73x87

ONEFRED - plastic trolley with coated push-bar and Boost wringer



REF.	CAPACITY (L)	SIZE (cm) ↓ ↓ ↓
0071LF1030YU	2x15	80x41x84
0071LF1050YU	2x25	82x41x84

ONEFRED - plastic trolley with plastic handle, basin and mop holder



REF.	CAPACITY (L)	SIZE (cm) ↓ ↓ ↓
0000LF0031YU	2X15	53x65x87
0000LF0051YU	2X25	53x73x87

ONEFRED - plastic trolley with plastic grip



REF.	CAPACITY (L)	PCK	SIZE (cm) ↓ ↓ ↓
0000LF0030YU	2x15	1	65x39x87
0000LF0050YU	2x25	1	73x40x87
0100LF0030YU	2x15	2	65x39x87
0100LF0050YU	2x25	2	73x40x87

ONEFRED - plastic trolley with coated push-bar



REF.	CAPACITY (L)	SIZE (cm) ↓ ↓ ↓
0000LF1030YU	2x15	80x41x84
0000LF1050YU	2x25	82x41x84

ONEFRED - plastic trolley with plastic grip, basket and fitting for Uni-Connect system



REF.	CAPACITY (L)	SIZE (cm) ↓ ↓ ↓
0000LF0033YU	2X15	51x65x87
0000LF0053YU	2X25	51x73x87

Learn more about Uni-Connect in the glass and surfaces section



PRODUCT PARTIALLY MADE OF PLASTIC COMPONENTS CERTIFIED PSV - PLASTIC SECOND LIFE

BUCKET/WRINGER
COMBOS

**PLASTIC MOP
TROLLEYS**

CHROMED AND RILSAN
COATED TROLLEYS

WRINGERS

MULTI-PURPOSE
BUCKETS

TOP-DOWN® BUCKETS

OTHER PLASTIC
BUCKETS

Fred trolleys

FRED - plastic trolley with coated push-bar



REF.	CAPACITY (L)	SIZE (cm) ↓ ↓ ↓
7960A	2x15	87x41x90
7965A	2x25	87x42x90

FRED - plastic trolley with plastic grip



REF.	CAPACITY (L)	SIZE (cm) ↓ ↓ ↓
7960A/P	2x15	65x41x88
7965A/P	2x25	69x42x93

FRED - plastic trolley with plastic grip and basket



REF.	CAPACITY (L)	SIZE (cm) ↓ ↓ ↓
03007960A/P	2x15	65x50x88
03007965A/P	2x25	69x51x93

FRED - plastic trolley with plastic grip and bag holder



REF.	CAPACITY (L)	SIZE (cm) ↓ ↓ ↓
04007960A/P	2x15	65x50x88
04007965A/P	2x25	69x51x93

Orion trolleys

ORION - plastic trolley



REF.	CAPACITY (L)	SIZE (cm) ↓ ↓ ↓
7961A	15	53x42x90
7962A	25	53x42x90

ORION - plastic trolley



REF.	CAPACITY (L)	SIZE (cm) ↓ ↓ ↓
7961A/P	15	53x42x93
7962A/P	25	53x42x93

ORION - plastic trolley



REF.	CAPACITY (L)	SIZE (cm) ↓ ↓ ↓
7961A/I	15	62x42x90
7962A/I	25	62x42x90



PRODUCT PARTIALLY MADE OF PLASTIC COMPONENTS CERTIFIED PSV - PLASTIC SECOND LIFE

Buckets and mop trolleys



BUCKET/WRINGER
COMBOS

**PLASTIC MOP
TROLLEYS**

CHROMED AND RILSAN
COATED TROLLEYS

WRINGERS

MULTI-PURPOSE
BUCKETS

TOP-DOWN® BUCKETS

OTHER PLASTIC
BUCKETS

Vega trolleys

VEGA LP0302 - plastic trolley 28 L



REF.	SIZE (cm)
0000LP0302A	71x42x90

VEGA LP0304 - plastic trolley 28 L



REF.	SIZE (cm)
0000LP0304A	80x42x90

VEGA LP0308 - plastic trolley 25 L



REF.	SIZE (cm)
0000LP0308A	71x42x90

VEGA LP0305 - plastic trolley 28 L



REF.	SIZE (cm)
0000LP0305A	71x42x112

VEGA LP0309 - plastic trolley 25 L



REF.	SIZE (cm)
0000LP0309A	62x42x112

VEGA LP0307 - plastic trolley 25 L



REF.	SIZE (cm)
0000LP0307A	71x42x112

VEGA 22LP0303 - plastic trolley 28 L



REF.	SIZE (cm)
0022LP0303A	80x42x112

VEGA LP0303 - plastic trolley 28 L



REF.	SIZE (cm)
0000LP0303A	80x42x112

BUCKETS AND MOP
TROLLEYS



PRODUCT PARTIALLY MADE OF PLASTIC COMPONENTS CERTIFIED PSV - PLASTIC SECOND LIFE

BUCKET/WRINGER COMBOS

PLASTIC MOP TROLLEYS

CHROMED AND RILSAN COATED TROLLEYS

WRINGERS

MULTI-PURPOSE BUCKETS

TOP-DOWN® BUCKETS

OTHER PLASTIC BUCKETS



Arka trolleys are built starting from the double plastic frame used for the Fred trolley, assembling all the available snap-in components very easily and quickly and above all **without using any screw**.
Arka is the most compact among Filmop multipurpose trolleys: even in the smallest places the operator has a complete professional cleaning system at his disposal.
Since 2013, they have been made partially with **"Second Life Plastic"** certified plastic components, in accordance with the environmental policies set out for Green Purchasing in the public administration.

ON REQUEST, WITH SURCHARGE



ON REQUEST, WITH SURCHARGE: with 2 wheels
ø 80 mm + 2 axial wheels
ø 200 mm



Arka trolleys

ARKA 20 - plastic trolley 28 L



REF.	SIZE (cm)
0022LP1280A	55x107x92

WRINGER VERSIONS

DEEP - side press wringer without bottom
TROLLEY REF. 0006LP1280A

ARKA 21 - plastic trolley 28 L



REF.	SIZE (cm)
0022LP1281A	56x107x111

WRINGER VERSIONS

DEEP - side press wringer without bottom
TROLLEY REF. 0006LP1281A

ARKA 22 - plastic trolley 28 L



REF.	SIZE (cm)
0022LP1282A	60x107x111

WRINGER VERSIONS

DEEP - side press wringer without bottom
TROLLEY REF. 0006LP1282A

ARKA 23 - plastic trolley 28 L



REF.	SIZE (cm)
0022LP1283A	65x107x111

WRINGER VERSIONS

DEEP - side press wringer without bottom
TROLLEY REF. 0006LP1283A

ARKA 24 - plastic trolley 28 L



REF.	SIZE (cm)
0022LP1284A	65x107x111

WRINGER VERSIONS

DEEP - side press wringer without bottom
TROLLEY REF. 0006LP1284A

ARKA 25 - plastic trolley 28 L



REF.	SIZE (cm)
0022LP1285A	65x107x111

WRINGER VERSIONS

DEEP - side press wringer without bottom
TROLLEY REF. 0006LP1285A



PRODUCT PARTIALLY MADE OF PLASTIC COMPONENTS CERTIFIED PSV - PLASTIC SECOND LIFE

Buckets and mop trolleys



BUCKET/WRINGER
COMBOS

**PLASTIC MOP
TROLLEYS**

CHROMED AND RILSAN
COATED TROLLEYS

WRINGERS

MULTI-PURPOSE
BUCKETS

TOP-DOWN® BUCKETS

OTHER PLASTIC
BUCKETS

ARKA 30 - plastic trolley 28 L



REF.	SIZE (cm) ↓ ↓ ↓
0005LP1250A	55x99x92

ARKA 31 - plastic trolley 28 L



REF.	SIZE (cm) ↓ ↓ ↓
0005LP1251A	56x99x111

ARKA 32 - plastic trolley 28 L



REF.	SIZE (cm) ↓ ↓ ↓
0005LP1252A	60x90x111

ARKA 33 - plastic trolley 28 L



REF.	SIZE (cm) ↓ ↓ ↓
0005LP1253A	65x99x111

ARKA 34 - plastic trolley 28 L



REF.	SIZE (cm) ↓ ↓ ↓
0005LP1254A	65x99x111

ARKA 35 - plastic trolley 28 L



REF.	SIZE (cm) ↓ ↓ ↓
0005LP1255A	65x99x111

Vega and Arka Top-Down® trolleys

VEGA TOP-DOWN® - plastic trolley



REF.	SIZE (cm) ↓ ↓ ↓
0000LP0321A2	88x59x112

ARKA TOP-DOWN® MIDI - plastic trolley



REF.	SIZE (cm) ↓ ↓ ↓
0000LP1211A2	99x59x111

ARKA TOP-DOWN® MAXI - plastic trolley



REF.	SIZE (cm) ↓ ↓ ↓
0000LP1221A2	120x59x111

⚠ BAGS, NOT INCLUDED



PRODUCT PARTIALLY MADE OF PLASTIC COMPONENTS CERTIFIED PSV - PLASTIC SECOND LIFE

Components for plastic mop trolleys

Plastic frame with ø 80 mm wheels for OneFred 30 lt and 50 lt



REF. NOTES
8730YSS

Plastic frame with ø 80 mm wheels and fitting for Uni-Connect, for OneFred 30 and 50 lt



REF. NOTES
78730YSS

Plastic frame with wheels ø 80 mm for Fred trolley 30 lt



REF. NOTES
8331SS

Plastic frame with wheels ø 80 mm for Fred 50 lt and Arka trolleys



REF. NOTES
8332SS

Plastic frame with wheels ø 80 mm for Orion and Vega trolleys



REF. NOTES
8335SS

Plastic frame with two wheels ø 80 mm and two wheels ø 200 mm for Arka trolley



REF. NOTES
8337SS

Plastic frame with two wheels ø 80 mm and two wheels ø 200 mm for Vega trolley



REF. NOTES
8338SS

Rilsan coated push-bar ø 18 mm for OneFred



REF. NOTES
R8061/2

Painted push-bar ø 18 mm for Fred trolley



REF. NOTES
R8061/1

Plastic grip for OneFred trolley



REF. NOTES
8731Y

Plastic grip for Orion and Fred trolleys



REF. NOTES
7963A

Reinforced push-bar for Orion and Vega trolleys



REF. NOTES
7966A

BUCKETS AND MOP TROLLEYS

Buckets and mop trolleys



BUCKET/WRINGER
COMBOS

**PLASTIC MOP
TROLLEYS**

CHROMED AND RILSAN
COATED TROLLEYS

WRINGERS

MULTI-PURPOSE
BUCKETS

TOP-DOWN® BUCKETS

OTHER PLASTIC
BUCKETS

Bag holder 50 lt for Vega trolley fitting
plastic push-bar art. 7966A



REF.	NOTES
P206002A	

Plastic bag holder for Orion-Fred-Vega
trolleys fitting push-bar art. 7963A and
supports art. P290800A - P179002A



REF.	NOTES
P206003A	

Bucket reduction for Orion trolley 15 lt



REF.	NOTES
60295A	

Reinforced plastic push-bar for Arka trolley



REF.	NOTES
7964A	

Set of two grey pushing grips (right and left) with
reinforcements (right and left) and fixing screws for Arka trolley



REF.	NOTES
P281001E	

Supporting plastic plate for Arka trolley



REF.	NOTES
P114011A	

Plastic bag holder complete with bag-stretchers
and cover with chek-list holder for Arka trolley



REF.	NOTES
P306010A	100 lt
P606010A	2x50 lt

Plastic divider 2x50 lt for bag holder
art. P606010A for Arka trolley



REF.	NOTES
P206010E	

Plastic bucket holder complete with supports
(small and medium) for Vega and Arka trolleys



REF.	NOTES
P220001E	

Big support for plastic bucket holder
art. P220001E



REF.	NOTES
P120004E	

Plastic basket or bucket holder complete
with supports for Vega and Arka trolleys



REF.	NOTES
P224002E	

Plastic carry basket for OneFred



REF.	NOTES
60406Y	

BUCKET/WRINGER
COMBOS

**PLASTIC MOP
TROLLEYS**

CHROMED AND RILSAN
COATED TROLLEYS

WRINGERS

MULTI-PURPOSE
BUCKETS

TOP-DOWN® BUCKETS

OTHER PLASTIC
BUCKETS

Plastic carry basket



REF.	NOTES	SIZE (cm)
60402A		↓ ↓ ↓ 32x13x14

Set of plastic paper holder with cover complete with 3 hooks



REF.	NOTES
P225004U	

Rilsan coated broom/mop holder support for Orion and Vega trolleys

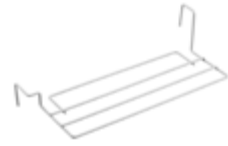

REF.	NOTES
R1050050	

Rilsan coated broom/mop holder support for Arka trolley

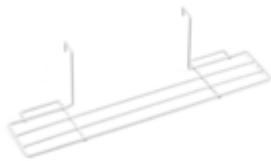

REF.	NOTES
R1050040	

Plastic quiver for polybags



REF.	NOTES
P120007A	

Plastic quiver for window squeegees, washers, scrapers



REF.	NOTES
P120008A	it can be applied to the holder code P120007A

Mop holder kit for OneFred trolleys



REF.	NOTES
0000SM00299	
Can be applied on models with plastic handle	

OneFred trolley sign hook



REF.	NOTES
0000SM00248U	

Rilsan coated bucket holder for 20 lt buckets, for Vega and Arka Top-Down®



REF.	NOTES
R1200103	lower bucket holder
R1200104	upper bucket holder

Accessories for plastic mop trolleys

Rilsan coated basket fitting the push-bar art. 8061/1 and R8061/2 for Fred and OneFred trolley



REF.	NOTES	SIZE (cm)
R8218		↓ ↓ ↓ 18x35x14

Plastic support for plastic basket art. 60402A, paper holder art. P225004A and quivers

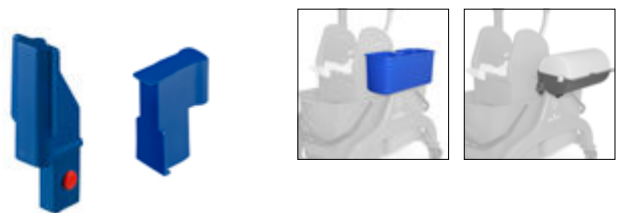

REF.	NOTES
P290800A	1. for Orion-Fred trolleys frame
P179002A	2. for bag holder art. P206002A of Vega trolley

Buckets and mop trolleys



BUCKET/WRINGER
COMBOS

PLASTIC MOP
TROLLEYS

**CHROMED AND
RILSAN COATED
TROLLEYS**

WRINGERS

MULTI-PURPOSE
BUCKETS

TOP-DOWN® BUCKETS

OTHER PLASTIC
BUCKETS

Trolleys 25 L

MINI JACK - chromed trolley 25 L



REF.	SIZE (cm) ↓ ↓ ↓
8010	51x40x87

FILMOP - chromed trolley 25 L



REF.	SIZE (cm) ↓ ↓ ↓
8016	56x40x98

Trolleys 30 L

JACK - chromed trolley 30 L



REF.	SIZE (cm) ↓ ↓ ↓
8024	67x39x88

JACK - Rilsan coated trolley 30 L



REF.	SIZE (cm) ↓ ↓ ↓
R8024	67x39x88

FILMOP - chromed trolley 30 L



REF.	SIZE (cm) ↓ ↓ ↓
8017	67x39x84

FILMOP - Rilsan coated trolley 30 L



REF.	SIZE (cm) ↓ ↓ ↓
R8017	67x39x84

SCALA - chromed trolley 30 L



REF.	SIZE (cm) ↓ ↓ ↓
8020	74x45x111

BUCKETS AND MOP
TROLLEYS

BUCKET/WRINGER
COMBOS

PLASTIC MOP
TROLLEYS

**CHROMED AND
RILSAN COATED
TROLLEYS**

WRINGERS

MULTI-PURPOSE
BUCKETS

TOP-DOWN® BUCKETS

OTHER PLASTIC
BUCKETS

Trolleys 50 L

JACK - chromed trolley 50 L with revolving wringer



REF.	SIZE (cm)
8032	78x40x83

JACK - chromed trolley 50 L



REF.	SIZE (cm)
8036	73x40x93

FILMOP - chromed trolley 50 L



REF.	SIZE (cm)
8018	99x41x88

Accessories for chromed and Rilsan coated trolleys

Chromed basket for Mini Jack and Filmop trolleys



REF.	NOTES	SIZE (cm)
8205/1		30,5x17,5x13,5

Chromed basket fitting push-bar for trolleys art. 8036, 8024 and 8010



REF.	NOTES	SIZE (cm)
8215		33x19,5x14,5

Chromed basket for Filmop trolley art. 8018



REF.	NOTES	SIZE (cm)
C30152		40x20x15,5

BUCKETS AND MOP TROLLEYS



BUCKET/WRINGER COMBOS

PLASTIC MOP TROLLEYS

CHROMED AND RILSAN COATED TROLLEYS

WRINGERS

MULTI-PURPOSE BUCKETS

TOP-DOWN® BUCKETS

OTHER PLASTIC BUCKETS

Optimal, efficient and ergonomic wringing

PATENTED SYSTEM

Boost optimises wringing, reducing drastically the efforts: the unique flat wringer **wrings 20% more with half the effort** compared to traditional wringers, minimizing cleaning time and costs while protecting the health and well-being of the operator.

+20% WRINGING



YouTube



Boost

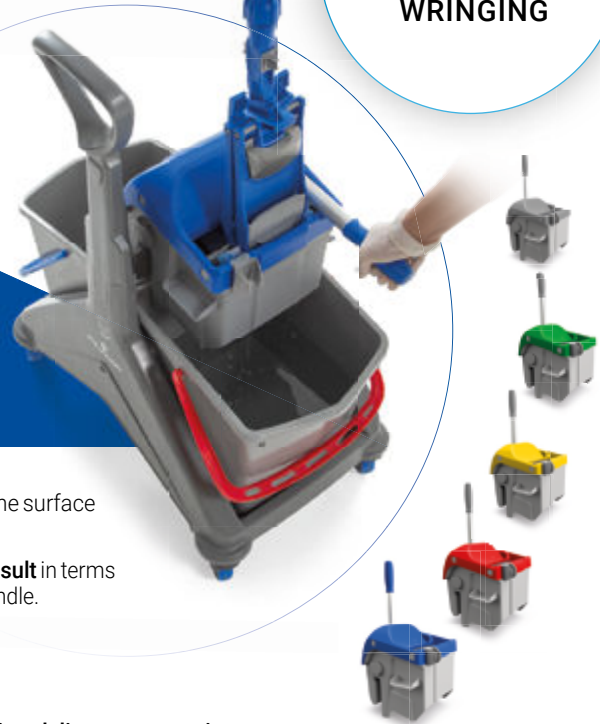

The deep and uniform pressure applied by the plate on the flat mop ensures **a complete wringing** and a **uniform distribution of the cleaning solution** on the surface to clean, ensuring the best result in terms of cleaning and hygiene.

Performance is steady over time: Boost allows you to **always get the desired result** in terms of wringing and soaking of the flat mop, whatever the pressure applied to the handle.

HALF EFFORT

Boost **prevents the onset of occupational diseases over time**: the wringer makes the effort and the operator simply has to push the handle to the end of the stroke.

Unlike traditional wringers that force the operator to repeat the operation several times to achieve the desired result with Boost **it is sufficient to lower the handle just 1 time to obtain the ideal wringing.**

100% VERSATILE

Boost meets different wringing needs: it is characterized by an innovative **adjustment system that allows to optimize the level of wringing** according to the degree of humidity you want to obtain and the type of flat mop in use.



TWICE



Specially designed to be used with **flat mopping systems**, it can be matched to any **Filmop trolley** line and to the special range of **wringer buckets**.

BUCKET/WRINGER COMBOS

PLASTIC MOP TROLLEYS

CHROMED AND RILSAN COATED TROLLEYS

WRINGERS

MULTI-PURPOSE BUCKETS

TOP-DOWN® BUCKETS

OTHER PLASTIC BUCKETS

Boost wringer

BOOST - plastic flat wringer



REF.	NOTES	
7003UA	grey with blue top and handgrip	
7003UB	grey with red top	
7003UC	grey with yellow top	
7003UF	grey with green top	
7003U	completely grey	

Components for Boost

Plastic top for Boost wringer



REF.	NOTES	
SLP036000001A		
SLP036000001B		
SLP036000001C		
SLP036000001F		
SLP036000001U		

Wringing plastic plate for Boost wringer



REF.	NOTES
SLP036000003U	

Aluminum handle for Boost wringer



REF.	NOTES	
8638A	with blue handgrup	
8638U	with gray handgrip	

Spring for Boost wringer



REF.	NOTES
U100017	

Handle holder for wringer



REF.	NOTES
P1780011U	

Fixing clip



REF.	NOTES
60005/2U	

Buckets and mop trolleys



BUCKET/WRINGER
COMBOS

PLASTIC MOP
TROLLEYS

CHROMED AND RILSAN
COATED TROLLEYS

WRINGERS

MULTI-PURPOSE
BUCKETS

TOP-DOWN® BUCKETS

OTHER PLASTIC
BUCKETS

Regular wringer

REGULAR - plastic down-press wringer with plastic gears



REF.

NOTES

7004A

7004E



Components for Regular

Plastic jaw for Regular wringer



REF.

NOTES

8640

Rotating handle holder for wringers art.
7004, 8000 and 8004



REF.

NOTES

8599

Plastic vertical gear for Regular wringer



REF.

NOTES

60500

60501

right vertical gear

left vertical gear

Plastic round gear for Regular wringer



REF.

NOTES

60502

60503

Right gear

Left gear

Aluminium pin for Regular wringer



REF.

NOTES

V8643

Chromed metal handle with plastic grip for
Regular wringer



REF.

NOTES

A8644A

Inside spring for Regular wringer



REF.

NOTES

8645

Fixing clip



REF.

NOTES

60005A

BUCKET/WRINGER
COMBOS

PLASTIC MOP
TROLLEYS

CHROMED AND RILSAN
COATED TROLLEYS

WRINGERS

MULTI-PURPOSE
BUCKETS

TOP-DOWN® BUCKETS

OTHER PLASTIC
BUCKETS

Punto wringer

PUNTO - plastic wringer with adjustable roll



REF.	NOTES
10000A	roll with position "+" (for a stronger wringing performance)
12000A	roll with position "-" (for a lighter wringing performance)
14000A	roll with central position (for a standard wringing performance)

Components for Punto

Universal rubber roll \varnothing 48 mm for Punto wringer



REF.	NOTES
P1780029U	

Roll support with covering for Punto wringer



REF.	NOTES
P2780060	

Stainless steel pin for roll of Punto wringer



REF.	NOTES
V1010801	

Inside spring for Punto wringer



REF.	NOTES
U100007	

Set of gears for Punto wringer



REF.	NOTES
P2780030	left set
P2780040	right set

Painted metal handle for Punto wringer



REF.	NOTES
P278006A	

Aluminium pin for handle for Punto wringer



REF.	NOTES
A1110810	

Fixing clip



REF.	NOTES
60005A	

Handle holder for Punto wringer



REF.	NOTES
P1780010	



BUCKET/WRINGER
COMBOS

PLASTIC MOP
TROLLEYS

CHROMED AND RILSAN
COATED TROLLEYS

WRINGERS

MULTI-PURPOSE
BUCKETS

TOP-DOWN® BUCKETS

OTHER PLASTIC
BUCKETS

Deep wringer

DEEP - plastic side press wringer without bottom



REF.

NOTES

7002A

Components for Deep

Painted metal handle for Deep wringer



REF.

NOTES

8633A

Painted pin for Deep wringer



REF.

NOTES

V8632

Covering for Deep wringer



REF.

NOTES

60356A

Plastic connecting rod for Deep wringer



REF.

NOTES

60307A right connecting rod
60308A left connecting rod

Rotating handle holder for Deep wringer



REF.

NOTES

60311H

Spring for Deep wringer



REF.

NOTES

8154

Fixing clip



REF.

NOTES

60005A

BUCKET/WRINGER
COMBOS

PLASTIC MOP
TROLLEYS

CHROMED AND RILSAN
COATED TROLLEYS

WRINGERS

MULTI-PURPOSE
BUCKETS

TOP-DOWN® BUCKETS

OTHER PLASTIC
BUCKETS

Side-press wringers

Plastic side-press wringer with plastic covering



REF.	NOTES
8002/1A	

Plastic side-press wringer



REF.	NOTES
8002A	

Components for wringers art. 8002 - 8002-1

Chromed metal handle with plastic grip for wringers art. 8002 and 8002/1



REF.	NOTES
8617A	

Painted pin for wringers art. 8002 and 8002/1



REF.	NOTES
V8618	

Reducer for wringer art. 8002



REF.	NOTES
8623E	

Covering for wringers art. 8002 and 8002/1



REF.	NOTES
60156A	

Plastic connecting rod for wringers art. 8002 and 8002/1



REF.	NOTES
60107A	right connecting rod
60108A	left connecting rod

Spring 81 mm for wringers art. 8002 and 8002/1



REF.	NOTES
8151	

Fixing clip



REF.	NOTES
60005A	

BUCKETS AND MOP TROLLEYS

Buckets and mop trolleys



BUCKET/WRINGER
COMBOS

PLASTIC MOP
TROLLEYS

CHROMED AND RILSAN
COATED TROLLEYS

WRINGERS

MULTI-PURPOSE
BUCKETS

TOP-DOWN® BUCKETS

OTHER PLASTIC
BUCKETS

Wringers with jaws

Plastic down-press wringer with galvanized metal gears



REF.	NOTES
8000A	
For mops more than 400 gr	

Plastic down-press wringer with plastic gears



REF.	NOTES
8004A	
For mops more than 400 gr	

Components for wringers art. 8000 - 8004

Jaw for wringers art. 8000
and 8004



REF.	NOTES
8066	

Rotating handle holder for
wringers art. 7004, 8000
and 8004



REF.	NOTES
8599	

Aluminium pin for plastic round
gear for wringer art. 8004



REF.	NOTES
0000SLA30401	long
0000SLA30402	short

Galvanized metal handle for
wringers art. 8000 and 8004



REF.	NOTES
8608/1	

Handle fixing flanges with
screws for wringers art. 8000
and 8004



REF.	NOTES
8613	

Plastic round gear for wringer
art. 8000



REF.	NOTES
60059	Right gear
60060	Left gear

Plastic vertical gear for wringer
art. 8004



REF.	NOTES
60057	right vertical gear
60058	left vertical gear

Inside spring 184 mm for
wringers art. 8000 and 8004



REF.	NOTES
8068	

Round galvanized metal gear
with pin for wringer art. 8000



REF.	NOTES
Z30132	with short pin
Z30133	with long pin

Vertical galvanized metal gear
for wringer art. 8000



REF.	NOTES
Z30130	right vertical gear
Z30131	left vertical gear

Reducer for wringers art. 8000
and 8004



REF.	NOTES
8601	

BUCKET/WRINGER
COMBOS

PLASTIC MOP
TROLLEYS

CHROMED AND RILSAN
COATED TROLLEYS

WRINGERS

**MULTI-PURPOSE
BUCKETS**

TOP-DOWN® BUCKETS

OTHER PLASTIC
BUCKETS

PRISMA - plastic bucket 28 L with double handle

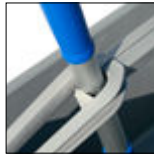

REF.	NOTES	SIZE (cm) ↓ ↓ ↓
0000SE0628U		38x57,5x27

PRISMA - plastic bucket 28 L with double handle and wheels



REF.	NOTES	SIZE (cm) ↓ ↓ ↓
0000SE1628U		38x57,5x34

PRISMA - plastic bucket 28 L with double handle and 2 rectangular plastic baskets 6 L



REF.	NOTES	SIZE (cm) ↓ ↓ ↓
0010SE0628U		38x57,5x28,5

PRISMA - plastic bucket 28 L with double handle, 2 rectangular plastic baskets 6 L and sieve



REF.	NOTES	SIZE (cm) ↓ ↓ ↓
0020SE0628U		38x57,5x35

Components and accessories for Prisma bucket

Plastic cover for bucket 28 L



REF.	NOTES	SIZE (cm) ↓ ↓ ↓
0000CP1128U		33x53x2,8

Rectangular plastic basket 6 L with coloured slots



REF.	NOTES	SIZE (cm) ↓ ↓ ↓
P0190047UA		33x13x26,5
P0190047UB		33x13x26,5

Plastic sieve for rectangular basket 6 L

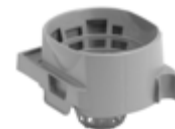

REF.	NOTES
21005U	

Plastic cover for rectangular basket 6 L



REF.	NOTES	SIZE (cm) ↓ ↓ ↓
P0190049U		13,5x29,8

Stainless steel sieve for rectangular basket 6 L

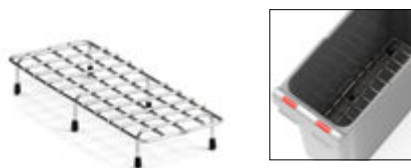

REF.	NOTES	SIZE (cm) ↓ ↓ ↓
I2190039		24,5x9,5

Plastic basket with 3 compartments complete with cover and handle



REF.	NOTES	SIZE (cm) ↓ ↓ ↓
P1190048UB		33x13,5x20,5

Buckets and mop trolleys



BUCKET/WRINGER
COMBOS

PLASTIC MOP
TROLLEYS

CHROMED AND RILSAN
COATED TROLLEYS

WRINGERS

**MULTI-PURPOSE
BUCKETS**

TOP-DOWN® BUCKETS

OTHER PLASTIC
BUCKETS

Toilet brush



REF.	NOTES	SIZE (cm) ↓ ↓ ↓
9148		61

Rectangular tool with strips 2,5 cm for strap
tape system, with Lock System



REF.	NOTES	SIZE (cm) ↓ ↓ ↓
5390U		20x8

MICRO-ACTIVA - ultra-microfiber mop with
backing for strap tape system



REF.	NOTES	SIZE (cm) ↓ ↓ ↓
000EPN01010		25x10

TOP-CLEAN - plastic mop holder with grip
and strips 2,5 cm for strap tape system



REF.	NOTES	SIZE (cm) ↓ ↓ ↓
5233U		30
5234U		40

Mop holder used with Brilliant system for cleaning interior glass, mirrors and all smooth vertical surfaces and with Top Clean system for cleaning tables in cafeterias, bars, kitchens, restaurants...

Ultra-microfiber mop head with backing for
strap tape system



REF.	NOTES	SIZE (cm) ↓ ↓ ↓
0000PN02016		30x11
0000PN03016		40x11

Ideal for stainless steel surfaces, mirrors and windows

Wheel ø 50 mm



REF.	NOTES
7949	For King, Spider, Ro-cket Wheels, Duo Pro System, Prisma, Twin, Top-Down®, Pick-Up, Trend and code 0000SE1428

Wheel ø 35 mm



REF.	NOTES
2793	for Prisma, Twin, Top-Down®, Pick-Up, Trend and art. 0000SE1428

BUCKETS AND MOP
TROLLEYS

Twin bucket

TWIN - plastic bucket 2x10 L with two plastic handles



REF.	NOTES	SIZE (cm) ↓ ↓ ↓
7914A		36x45x26

Fitting window washer 35 cm

Plastic sieve for Twin bucket



REF.	NOTES
21021A	

Fitting window washer 35 cm

Plastic sieve for Twin bucket



REF.	NOTES
21002	

Available while stocks last

Plastic cover for Twin bucket



REF.	NOTES
60294U	

Set of holders for plastic cover for Twin bucket



REF.	NOTES
7915A	

Wheel ø 35 mm



REF.	NOTES
2793	for Prisma, Twin, Top-Down®, Pick-Up, Trend and art. 0000SE1428

Wheel ø 50 mm



REF.	NOTES
7949	For King, Spider, Rocket Wheels, Duo Pro System, Prisma, Twin, Top-Down®, Pick-Up, Trend and code 0000SE1428



BUCKET/WRINGER
COMBOS

PLASTIC MOP
TROLLEYS

CHROMED AND RILSAN
COATED TROLLEYS

WRINGERS

MULTI-PURPOSE
BUCKETS

TOP-DOWN® BUCKETS

OTHER PLASTIC
BUCKETS

Top-Down® buckets complete

TOP-DOWN® - 8 lt plastic bucket with plastic handle and hermetic cover

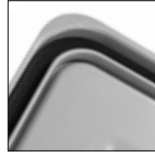

REF.	NOTES	SIZE (cm) ↓ ↓ ↓
0000SE1308A		17x36x23
0000SE1308B		17x36x23
0000SE1308C		17x36x23

They are the ideal solution for cloth soaking procedures

TOP-DOWN® 10 lt - plastic bucket with plastic handle and hermetic cover

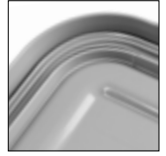

REF.	NOTES	SIZE (cm) ↓ ↓ ↓
0000SE1310A		24x55x19
0000SE1310B		24x55x19

They are the ideal solution for cloth soaking procedures

TOP-DOWN® - 14 lt plastic bucket with plastic handle and hermetic cover

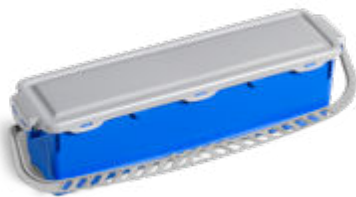

REF.	NOTES	SIZE (cm) ↓ ↓ ↓
0000SE1314A		20x77x18

They are the ideal solution for cloth soaking procedures

TOP-DOWN® 20 lt - plastic bucket with plastic handle and hermetic cover

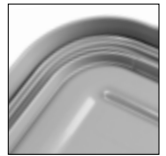

REF.	NOTES	SIZE (cm) ↓ ↓ ↓
0000SE1322A		24x55x27
0000SE1322B		24x55x27
0000SE1322U		24x55x27
0000SE1322UA	grey bucket with blue handle	24x55x27
0000SE1322UB	grey bucket with red handle	24x55x27

They are the ideal solution for cloth soaking procedures

Components and accessories for Top-Down®

Plastic bucket 8 L with plastic handle



REF.	NOTES	SIZE (cm) ↓ ↓ ↓
0000SE1208A		17x36x23
0000SE1208B		17x36x23
0000SE1208C		17x36x23

Plastic bucket 10 L with plastic handle



REF.	NOTES	SIZE (cm) ↓ ↓ ↓
0000SE1210A		24x55x19
0000SE1210B		24x55x19

14 lt plastic bucket with plastic handle



REF.	NOTES	SIZE (cm) ↓ ↓ ↓
0000SE1214A		20x77x18

BUCKET/WRINGER
COMBOS

PLASTIC MOP
TROLLEYS

CHROMED AND RILSAN
COATED TROLLEYS

WRINGERS

MULTI-PURPOSE
BUCKETS

TOP-DOWN® BUCKETS

OTHER PLASTIC
BUCKETS

Plastic bucket 20 Lt with plastic handle



REF.	NOTES	SIZE (cm) ↓ ↓ ↓
0000SE1222A		24x55x27
0000SE1222B		24x55x27
0000SE1222U		24x55x27
0000SE1222UA	grey bucket with blue handle	24x55x27
0000SE1222UB	grey bucket with red handle	24x55x27

Hermetic plastic cover for
8 Lt Top-Down® bucket

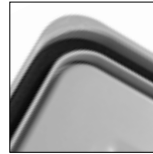

REF.	NOTES
0000CP1108U	

Hermetic plastic cover for
10 and 20 Lt Top-Down® bucket

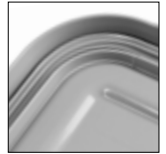

REF.	NOTES	SIZE (cm) ↓ ↓ ↓
0000CP1122U		24,5x54,5x3,5

Hermetic plastic cover for
14 Lt Top-Down® bucket



REF.	NOTES
0000CP1114U	

Plastic divider for Top-Down® bucket 20 Lt



REF.	NOTES
P190350E	

The specific plastic reducer is ideal to keep the mop compact inside the bucket and to make it easier to pick up them from the bucket directly with the mop holder

Pierced plastic sieve for Top-Down® bucket

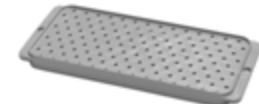

REF.	NOTES	SIZE (cm) ↓ ↓ ↓
P1190041U	for Top-Down® 8 lt	33,3x14,2x2,2
P1190042U	for Top-Down® 10 and 20 lt	54x20x3

Ideal for a uniform distribution of the cleaning solution For a quick pre-soaking (max 15 minutes)

Stainless steel sieve for
Top-Down® bucket 20 L



REF.	NOTES
I2190044	

Plastic sieve Top-Down® 10 and 20 Lt



REF.	NOTES
21004	

Wheel ø 35 mm



REF.	NOTES
2793	for Prisma, Twin, Top-Down®, Pick-Up, Trend and art. 0000SE1428

Wheel ø 50 mm



REF.	NOTES
7949	For King, Spider, Ro-cket Wheels, Duo Pro System, Prisma, Twin, Top-Down®, Pick-Up, Trend and code 0000SE1428

Buckets and mop trolleys



BUCKET/WRINGER
COMBOS

PLASTIC MOP
TROLLEYS

CHROMED AND RILSAN
COATED TROLLEYS

WRINGERS

MULTI-PURPOSE
BUCKETS

TOP-DOWN® BUCKETS

**OTHER PLASTIC
BUCKETS**

Other buckets

Plastic bucket 25 L with plastic handle



REF.	NOTES	SIZE (cm) ↓ ↓ ↓
8107A	■	36,2x32,4x31,7
8107B	■	36,2x32,4x31,7

Grey plastic 25l mop bucket with coloured plastic handle for OneFred



REF.	NOTES	SIZE (cm) ↓ ↓ ↓
0000SE0125UA	■	36,8x40,5x32,3
0000SE0125UB	■	36,8x40,5x32,3

Plastic bucket 15 L with plastic handle



REF.	NOTES	SIZE (cm) ↓ ↓ ↓
8108A	■	34x33,5x28,3
8108B	■	34x33,5x28,3
8108C	■	34x33,5x28,3

Grey plastic 15l mop bucket with coloured plastic handle for OneFred



REF.	NOTES	SIZE (cm) ↓ ↓ ↓
0000SE0115UA	■	32,5x32,7x32
0000SE0115UB	■	32,5x32,7x32

Plastic bucket 12 L with plastic handle



REF.	NOTES	SIZE (cm) ↓ ↓ ↓
8211/1A	■	27,7x32,5x26
8211/1B	■	27,7x32,5x26

Plastic bucket 8 L with plastic handle on the edge



REF.	NOTES	SIZE (cm) ↓ ↓ ↓
0000SE0108A	■	16x33x23,5
0000SE0108B	■	16x33x23,5
0000SE0108C	■	16x33x23,5

Plastic bucket 6 L with plastic handle



REF.	NOTES	SIZE (cm) ↓ ↓ ↓
8218A	■	20,8x26x21,5
8218B	■	20,8x26x21,5
8218C	■	20,8x26x21,5
8218F	■	20,8x26x21,5

Grey plastic bucket 6 L with coloured short plastic handle



REF.	NOTES	SIZE (cm) ↓ ↓ ↓
0000SE0106U	■	21x26x23,5
0000SE0106UA	■	21x26x23,5
0000SE0106UB	■	21x26x23,5
0000SE0106UC	■	21x26x23,5
0000SE0106UF	■	21x26x23,5

Plastic bucket 4 L with plastic handle



REF.	NOTES	SIZE (cm) ↓ ↓ ↓
0000SE0104A	■	17x25,5x19,5
0000SE0104B	■	17x25,5x19,5
0000SE0104C	■	17x25,5x19,5
0000SE0104F	■	17x25,5x19,5

BUCKET/WRINGER COMBOS

PLASTIC MOP TROLLEYS

CHROMED AND RILSAN COATED TROLLEYS

WRINGERS

MULTI-PURPOSE BUCKETS

TOP-DOWN® BUCKETS

OTHER PLASTIC BUCKETS

Grey plastic bucket 4 L with coloured plastic handle on the edge



REF.	NOTES	SIZE (cm) ↓ ↓ ↓
0000SE0204U	Grey	16,5x21x22,5
0000SE0204UA	Blue	16,5x21x22,5
0000SE0204UB	Red	16,5x21x22,5
0000SE0204UC	Yellow	16,5x21x22,5
0000SE0204UF	Green	16,5x21x22,5

Plastic bucket 28 L with 2 plastic handles and removable divider



REF.	NOTES	SIZE (cm) ↓ ↓ ↓
0000SE1128B	Red	32,5x44,5x31,5

Plastic bucket 28 L with plastic handle



REF.	NOTES	SIZE (cm) ↓ ↓ ↓
0000SE1428A	Blue	32x52x27
0000SE1428B	Red	32x52x27

Accessories for other buckets

Set of 3 stickers for buckets



REF.	NOTES
3048	

Wringer with roll for microfiber cloths fitting buckets 6 L and 4 L



REF.	NOTES	SIZE (cm) ↓ ↓ ↓
16000A		35x12,5x22

Pierced plastic sieve for buckets



REF.	NOTES
P1190044U	for bucket 6 L
P1190050U	for bucket 4 L art. 0000SE0104

Transparent plastic cover



REF.	NOTES
60222	for bucket 4 L art. 0000SE0104
60232	for bucket 6 L
60230	for bucket 12 L

Transparent plastic cover with hinges



REF.	NOTES
0000CP1204T	for bucket 4 L art. 0000SE0104
0000CP1205T	for 4l bucket item no. 0000SE0204
0000CP1206T	for bucket 6 L

Hermetic transparent plastic cover for buckets 4 L art. 0000SE0104



REF.	NOTES
0000CP1104T	
Ideal for soaked cloths on a roll	

Buckets and mop trolleys



BUCKET/WRINGER
COMBOS

PLASTIC MOP
TROLLEYS

CHROMED AND RILSAN
COATED TROLLEYS

WRINGERS

MULTI-PURPOSE
BUCKETS

TOP-DOWN® BUCKETS

OTHER PLASTIC
BUCKETS

Plastic divider for basket art. P1199900U -
bucket support art. P220001E - buckets 4 L
art. 0000SE0104



REF.	NOTES
P1909932U	

Plastic cover for bucket 28 L



REF.	NOTES	SIZE (cm)
0000CP1128U		↓ ↓ ↓ 33x53x2,8

Wheel ø 35 mm



REF.	NOTES
2793	for Prisma, Twin, Top-Down®, Pick-Up, Trend and art. 0000SE1428

Wheel ø 50 mm



REF.	NOTES
7949	For King, Spider, Ro-cket Wheels, Duo Pro System, Prisma, Twin, Top-Down®, Pick-Up, Trend and code 0000SE1428



Multipurpose trolleys

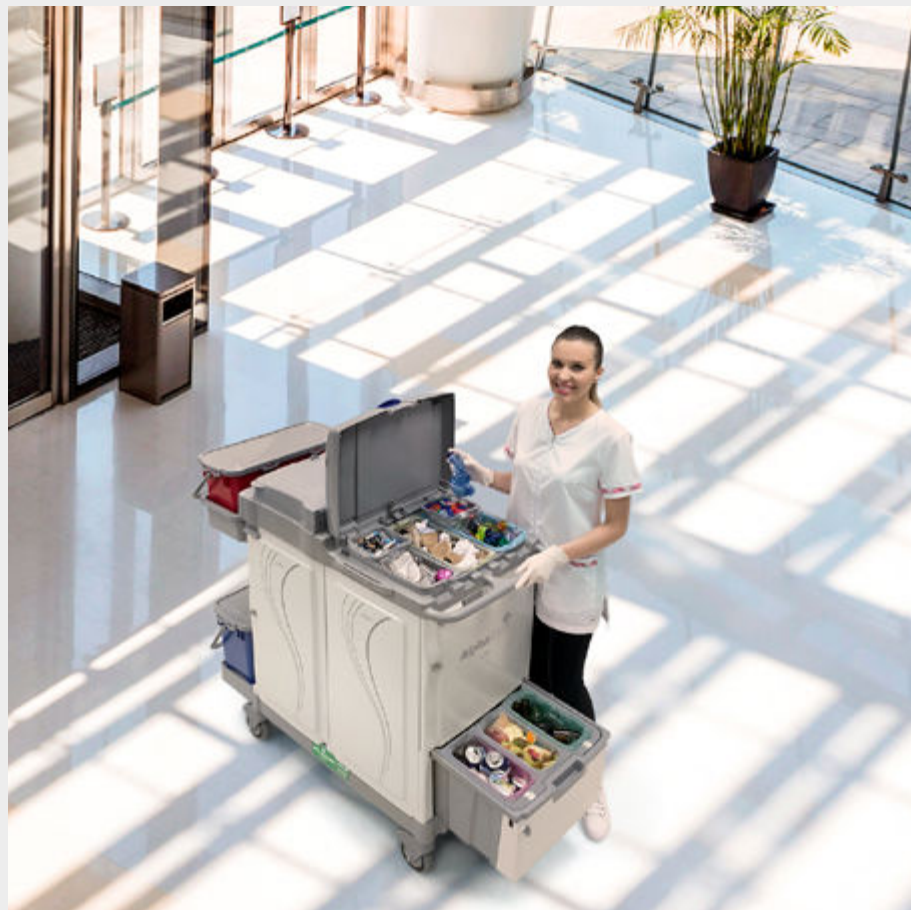

Alpha

Morgan

Chromed and Rilsan
coated trolleys



Multipurpose trolleys

ALPHA

MORGAN

CHROMED AND RILSAN COATED TROLLEYS

Alpha

COLLECTION AND STORAGE 186

WASHING 188

SOAKING 193

METAL FREE 197

Alpha is a complete range of **tailor-made multipurpose trolleys**, designed to **satisfy any cleaning need** thanks to the modularity of their components that can be combined with many accessories.

The available configurations are endless, from the most compact to the most complete version to satisfy any request in the best possible way.

Each trolley can be freely customized, having everything you need for a complete cleaning always at your fingertips.

Alpha trolleys are partly made of **plastic components certified "Plastic Second Life"**: an important choice that confirms the engagement to look for eco friendly solutions meant to **reduce the environmental impact** of the products, without giving up the **high quality standards**.

MULTIPURPOSE
TROLLEYS



Multipurpose trolleys

ALPHA

MORGAN

CHROMED AND RILSAN COATED TROLLEYS

A CUSTOMISED TROLLEY

The modularity characterizing the complete range and the wide assortment of accessories allow to **customize each part of the trolley** according to the specific needs and requirements.

The Alpha trolley line is characterized by an **extraordinary attention to details**, not only from the design point of view, but also from the aesthetic point of view.

Visually pleasing working tools can make the difference: thanks to their well-finished design and modern style Alpha trolleys are an **elegant solution to improve the offered standard service**.

Elegant trolleys thanks to their smooth lines and rounded edges **fitting any environment with their sobriety and simplicity**.



There is a **huge variety of customization possibilities**; discover all components and accessories at your disposal from page 198 onwards.



MULTIPURPOSE
TROLLEYS



STORAGE COMPARTMENT

- Composed of **one or more units**
- **Open version or completely closed**
- Customizable with **buckets, drawers, shelves**, etc.



WASHING AREA

- Available with the **traditional wet mopping system with wringer**
- Top-Down buckets for **pre-soaking**
- Equodose for **soaking on demand**

Multipurpose trolleys

ALPHA

MORGAN

CHROMED AND RILSAN COATED TROLLEYS



CUSTOMIZABLE GRAPHICS

- On request, doors and walls can be customized with **pictures, drawings, pictures and logo**
- Element perfectly **integrated in the surrounding area**
- Rolling **advertisement**
- Means of **communication**



Compatible with Uni-Connect system



180°



GREEN CERTIFICATIONS

- **Carbon Footprint** Systematic Approach
- **PSV** - Plastic Second Life
- **EU Ecolabel** for some Alpha



WASTE COLLECTION COMPARTMENT

- **Fixed or foldable** bagholder
- **Front or side** door
- **Standard or adjustable** push-grip



ALPHA

MORGAN

CHROMED AND RILSAN COATED TROLLEYS

Collection and storage



Specific versions ideal to for all the cleaning operations: waste collection, storage of cleaning tools.

Products partly made with plastic components certified PSV - Second Life Plastic.



STANDARD



Wheels ø 100 mm

ON REQUEST, WITH SURCHARGE



Rubber wheels ø 125 mm



Wheels ø 125 mm



bag holder 150 L with adjustable push-grip



Foldable bag holder 120 L

ALPHA 0101003 - storage



REF.	SIZE (cm)
MA0101003U000	75x58x102

ALPHA 1100 - collection + storage



REF.	SIZE (cm)
0000MA1100U00	75x58x102

ALPHA 1101 - collection + storage



REF.	SIZE (cm)
0000MA1101U00	75x58x111

ALPHA 2101 - collection + storage



REF.	SIZE (cm)
0000MA2101U00	126x58x102

ALPHA 0001003 - storage



REF.	SIZE (cm)
MA0001003U000	55x55x101

ALPHA 2103-14 - storage



REF.	SIZE (cm)
0000MA2103U14	81x55x101

MULTIPURPOSE TROLLEYS

Multipurpose trolleys



ALPHA

MORGAN

CHROMED AND RILSAN COATED TROLLEYS

ALPHA 4101 - collection + storage



REF.	SIZE (cm)
0000MA4101U00	92x58x111

ALPHA 5101 - collection + storage



REF.	SIZE (cm)
0000MA5101U00	92x58x114

ALPHA 5113-01 - storage



REF.	SIZE (cm)
0000MA5113U01	104x55x101

ALPHA 6105 - collection + storage

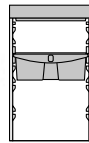

REF.	SIZE (cm)
0000MA6105U00	133x58x102

ALPHA 0001101 Split system - collection + storage



REF.	SIZE (cm)
MA0001101U000	54x54x104

ALPHA 3301000 - collection + storage

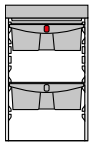

REF.	SIZE (cm)
MA3301000U000	97x58x110

Trolley dimensions with closed foldable bag holder 66x58x145 cm

ALPHA 0301002 - collection + storage



REF.	SIZE (cm)
MA0301002U000	58x81x102

ALPHA 8100 - collection + storage

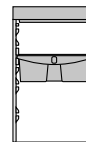

REF.	SIZE (cm)
2000MA8100U00	98x58x102

ALPHA 3801000 - collection + storage

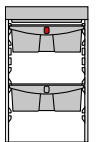

REF.	SIZE (cm)
MA3801000U001	124x58x110

MULTIPURPOSE TROLLEYS

⚠ EQUODOSE®, BAGS, COVER FOR BAG HOLDER 120 L AND PEDAL SET NOT INCLUDED



ALPHA

MORGAN

CHROMED AND RILSAN COATED TROLLEYS

ALPHA 0003002 - storage

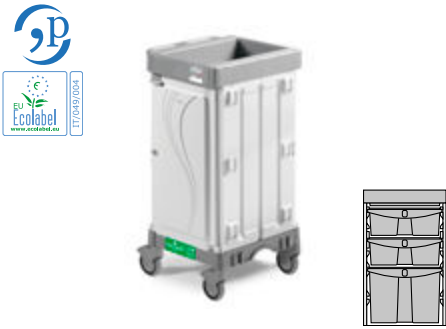

REF.	SIZE (cm)
MA0003002U003	55x55x107
Standard equipped with rubber wheels ø 125 mm	

ALPHA 3803003 - collection + storage

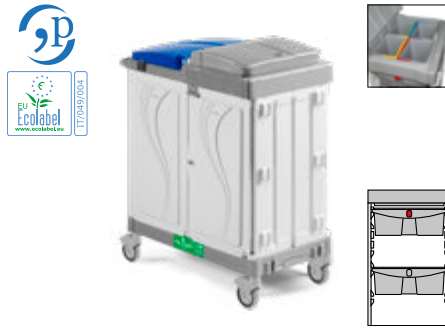

REF.	SIZE (cm)
MA3803003U000	98x58x115
Standard equipped with rubber wheels ø 125 mm	

ALPHA 0603019 - storage

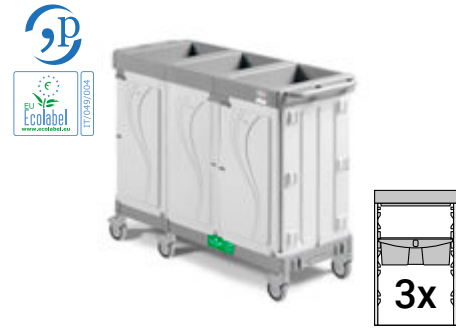

REF.	SIZE (cm)
MA0603019U000	146x58x107
Standard equipped with rubber wheels ø 125 mm	

Washing



Specific versions ideal for all the cleaning operations: waste collection, storage of consumables and cleaning tools, dusting and wet mopping of floors and surfaces.

Products partly made with plastic components certified PSV - Second Life Plastic.



STANDARD



ON REQUEST, WITH SURCHARGE

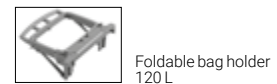

ALPHA 1104 - collection + washing



REF.	SIZE (cm)
0000MA1104U00	97x68x111

ALPHA 1104 - collection + washing with Boost



REF.	SIZE (cm)
0071MA1104U00	97x68x111

ALPHA 1105 - collection + washing



REF.	SIZE (cm)
0000MA1105U00	97x58x111

WRINGER VERSIONS

- BOOST - flat wringer**
TROLLEY REF. **0071MA1104U00**
- PUNTO - roller wringer**
TROLLEY REF. **0022MA1104U00**

WRINGER VERSIONS

- REGULAR - jaw wringer**
TROLLEY REF. **0000MA1104U00**
- PUNTO - roller wringer**
TROLLEY REF. **0022MA1104U00**

⚠ EQUODOSE®, BAGS, COVER FOR BAG HOLDER 120 L AND PEDAL SET NOT INCLUDED

Multipurpose trolleys



ALPHA

MORGAN

CHROMED AND RILSAN COATED TROLLEYS

ALPHA 0101406 - collection + washing



REF.	SIZE (cm)
	↓↓↓
MA0101406U00	83x56x111

ALPHA 0001000 - collection + washing



REF.	SIZE (cm)
	↓↓↓
MA0001000U00	55x55x102
Complete trolley sizes with OneFred 122x65x102 cm	

ALPHA 4103 - collection + washing



REF.	SIZE (cm)
	↓↓↓
0000MA4103U00	92x68x111

WRINGER VERSIONS

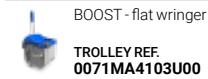

BOOST - flat wringer
TROLLEY REF. **0071MA4103U00**



PUNTO - roller wringer
TROLLEY REF. **0022MA4103U00**

ALPHA 4103 - collection + washing with Boost



REF.	SIZE (cm)
	↓↓↓
0071MA4103U00	92x68x111

WRINGER VERSIONS

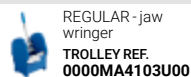

REGULAR - jaw wringer
TROLLEY REF. **0000MA4103U00**

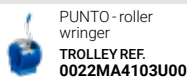

PUNTO - roller wringer
TROLLEY REF. **0022MA4103U00**

ALPHA 0401405 - collection + washing



REF.	SIZE (cm)
	↓↓↓
MA0401405U00	95x56x111

ALPHA 0401402 - collection + washing



REF.	SIZE (cm)
	↓↓↓
MA0401402U00	102x68x111

ALPHA 5107 - collection + storage + washing



REF.	SIZE (cm)
	↓↓↓
0000MA5107U00	133x68x120

WRINGER VERSIONS

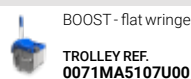

BOOST - flat wringer
TROLLEY REF. **0071MA5107U00**

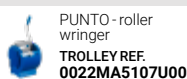

PUNTO - roller wringer
TROLLEY REF. **0022MA5107U00**

ALPHA 5107 - collection + storage + washing with Boost



REF.	SIZE (cm)
	↓↓↓
0071MA5107U00	133x68x120

WRINGER VERSIONS

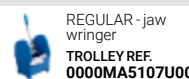

REGULAR - jaw wringer
TROLLEY REF. **0000MA5107U00**



PUNTO - roller wringer
TROLLEY REF. **0022MA5107U00**

ALPHA 5108-18 - collection + storage + washing



REF.	SIZE (cm)
	↓↓↓
0000MA5108U18	133x68x114

WRINGER VERSIONS

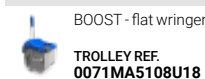

BOOST - flat wringer
TROLLEY REF. **0071MA5108U18**

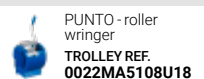

PUNTO - roller wringer
TROLLEY REF. **0022MA5108U18**

⚠ EQUODOSE®, BAGS, COVER FOR BAG HOLDER 120 L AND PEDAL SET NOT INCLUDED

MULTIPURPOSE TROLLEYS



ALPHA

MORGAN

CHROMED AND RILSAN COATED TROLLEYS

ALPHA 5108-18 - collection + storage + washing with **Boost**



REF.	SIZE (cm)
0071MA5108U18	133x68x114

WRINGER VERSIONS



ALPHA 0501415 - collection + storage + washing



REF.	SIZE (cm)
MA0501415U000	139x56x114

ALPHA 0201000 - collection + storage + washing



REF.	SIZE (cm)
MA0201000U000	97x58x114

Trolley dimensions with closed foldable bag holder 66x58x145 cm - Complete trolley sizes with OneFred 160x65x114 cm

ALPHA 5110 - collection + storage + washing



REF.	SIZE (cm)
0000MA5110U00	133x69x114

ALPHA 5601416 - collection + storage + washing with **Boost**



REF.	SIZE (cm)
MA5601416U003	133x68x114

WRINGER VERSIONS

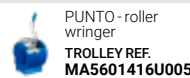
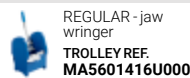

ALPHA 6103 - collection + storage + washing



REF.	SIZE (cm)
0000MA6103U00	133x68x114

WRINGER VERSIONS

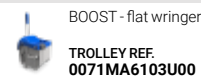

ALPHA 6103 - collection + storage + washing with **Boost**



REF.	SIZE (cm)
0071MA6103U00	133x68x114

WRINGER VERSIONS

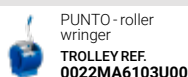
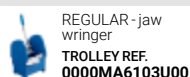

ALPHA 3601400 - collection + storage + washing with **Boost**



REF.	SIZE (cm)
MA3601400U060	133x68x110

WRINGER VERSIONS

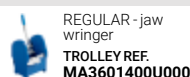

Trolley dimensions with closed foldable bag holder 100x68x145 cm

ALPHA 4601400 - collection + storage + washing with **Boost**



REF.	SIZE (cm)
MA4601400U060	133x68x110

WRINGER VERSIONS

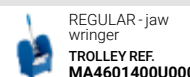

Trolley dimensions with closed foldable bag holder 100x68x145 cm

EQUODOSE®, BAGS, COVER FOR BAG HOLDER 120 L AND PEDAL SET NOT INCLUDED

MULTIPURPOSE TROLLEYS

Multipurpose trolleys



ALPHA

MORGAN

CHROMED AND RILSAN COATED TROLLEYS

ALPHA MR0601400 Link-Up system - collection + storage + washing with **Boost**



REF.	SIZE (cm)
MR0601400U00	153x68x114

WRINGER VERSIONS

- REGULAR - jaw wringer
TROLLEY REF. MR0601400U017
- PUNTO - roller wringer
TROLLEY REF. MR0601400U005

ALPHA 7101 - collection + washing with **Boost**



REF.	SIZE (cm)
0071MA7101U00	98x68x111

WRINGER VERSIONS

- REGULAR - jaw wringer
TROLLEY REF. 2000MA7101U00
- PUNTO - roller wringer
TROLLEY REF. 0022MA7101U00

ALPHA 0701500 Split system - collection + storage + washing with **Boost**



REF.	SIZE (cm)
MA0701500U011	98x68x111

WRINGER VERSIONS

- REGULAR - jaw wringer
TROLLEY REF. MA0701500U000
- PUNTO - roller wringer
TROLLEY REF. MA0701500U003

ALPHA 0701450 - collection + washing with **Boost**



REF.	SIZE (cm)
MA0701450U011	108x68x111

WRINGER VERSIONS

- REGULAR - jaw wringer
TROLLEY REF. MA0701450U000
- PUNTO - roller wringer
TROLLEY REF. MA0701450U003

ALPHA 0701404 - collection + washing



REF.	SIZE (cm)
MA0701404U000	106x56x111

ALPHA 8104 - collection + storage + washing



REF.	SIZE (cm)
1000MA8104U00	139x68x114

WRINGER VERSIONS

- BOOST - flat wringer
TROLLEY REF. 0071MA8104U00
- PUNTO - roller wringer
TROLLEY REF. 1022MA8104U00

ALPHA 8104 - collection + storage + washing with **Boost**

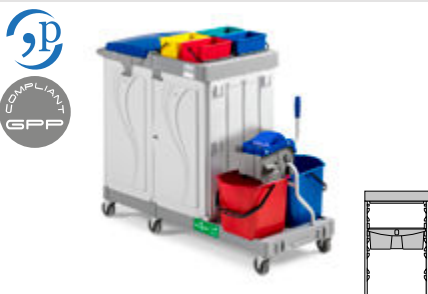

REF.	SIZE (cm)
0071MA8104U00	139x68x114

WRINGER VERSIONS

- REGULAR - jaw wringer
TROLLEY REF. 1000MA8104U00
- PUNTO - roller wringer
TROLLEY REF. 1022MA8104U00

ALPHA MR3801400 Link-Up system - collection + storage + washing with **Boost**

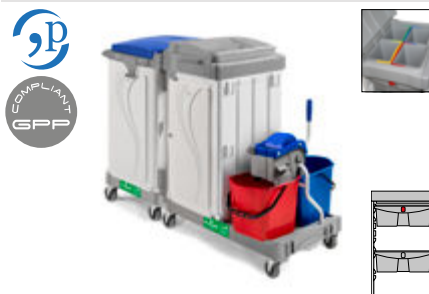

REF.	SIZE (cm)
MR3801400U030	155x68x110

WRINGER VERSIONS

- REGULAR - jaw wringer
TROLLEY REF. MR3801400U000
- PUNTO - roller wringer
TROLLEY REF. MR3801400U004

ALPHA 5801408 - collection + storage + washing with **Boost**

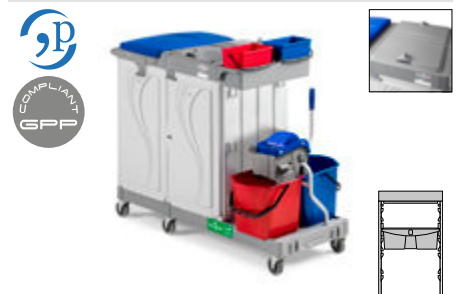

REF.	SIZE (cm)
MA5801408U003	139x68x111

WRINGER VERSIONS

- REGULAR - jaw wringer
TROLLEY REF. MA5801408U000
- PUNTO - roller wringer
TROLLEY REF. MA5801400U004

⚠ EQUODOSE®, BAGS, COVER FOR BAG HOLDER 120 L AND PEDAL SET NOT INCLUDED

MULTIPURPOSE TROLLEYS



ALPHA

MORGAN

CHROMED AND RILSAN COATED TROLLEYS

ALPHA 3801400 - collection + storage + washing with Boost



REF.	SIZE (cm)
MA3801400U030	139x68x110

WRINGER VERSIONS



ALPHA 0801114 Split system - collection + storage + washing



REF.	SIZE (cm)
MA0801114U000	98x58x114

Complete trolley sizes with OneFred 161x65x114 cm

ALPHA 3801500 Split system - collection + storage + washing with Boost

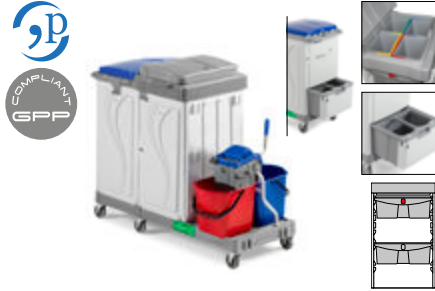

REF.	SIZE (cm)
MA3801500U030	139x68x110

WRINGER VERSIONS



ALPHA 0801407 - collection + storage + washing



REF.	SIZE (cm)
MA0801407U000	145x56x114

ALPHA 4801400 - collection + storage + washing with Boost



REF.	SIZE (cm)
MA4801400U030	139x68x110

WRINGER VERSIONS





ALPHA

MORGAN

CHROMED AND RILSAN COATED TROLLEYS

Soaking



Versions designed to meet the various needs of cleaning and disinfection in healthcare environments, with pre-impregnation systems or "on demand" impregnation with Equodose.

Products partly made with plastic components certified PSV - Second Life Plastic.



STANDARD



Wheels ø 125 mm

ON REQUEST, WITH SURCHARGE



Rubber wheels ø 125 mm



Wheels ø 100 mm



bag holder 150 L with adjustable push-grip



Foldable bag holder 120 L

ALPHA 1670 - collection + soaking



REF.	SIZE (cm)
0000MA1670U00	78x58x111

ALPHA 1673 - collection + soaking



REF.	SIZE (cm)
0000MA1673U00	107x58x111

ALPHA 0406700 - soaking



REF.	SIZE (cm)
MA0406700U000	92x58x115

ALPHA 2672 - collection + storage + soaking



REF.	SIZE (cm)
0300MA2672U00	118x58x114

Sizes trolley with closed foldable bag holder 87x58x149 cm

ALPHA 5671 - collection + storage + soaking



REF.	SIZE (cm)
0300MA5671U00	118x58x114

ALPHA 0506702 - collection + storage + soaking with Click Safe system



REF.	SIZE (cm)
MA0506702U032	118x58x114

Click Safe system requires the use of the corresponding Click Safe folding mop holder (See the catalog under the line Soaking and Floor Washing Systems - system with pockets)



ALPHA

MORGAN

CHROMED AND RILSAN COATED TROLLEYS

ALPHA 0506711 - collection + storage + soaking



REF.	SIZE (cm) ↓ ↓ ↓
MA0506711U006	123x65x118

ALPHA 2606701 - collection + storage + soaking

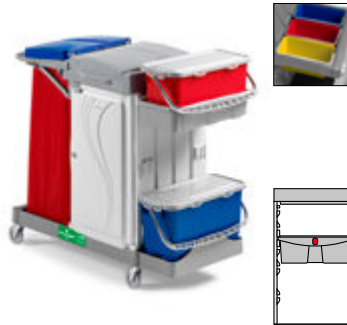

REF.	SIZE (cm) ↓ ↓ ↓
MA2606701U050	118x58x110

ALPHA 6670 - collection + storage + soaking

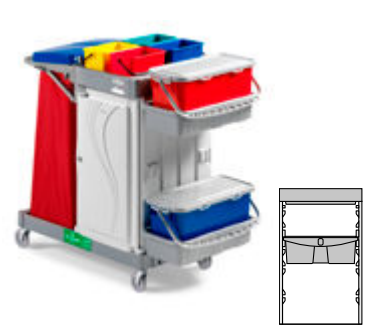

REF.	SIZE (cm) ↓ ↓ ↓
0300MA6670U00	118x58x114

ALPHA 3606718 - collection + storage + soaking



REF.	SIZE (cm) ↓ ↓ ↓
MA3606718U006	123x65x118

ALPHA 3306700 - collection + storage + soaking

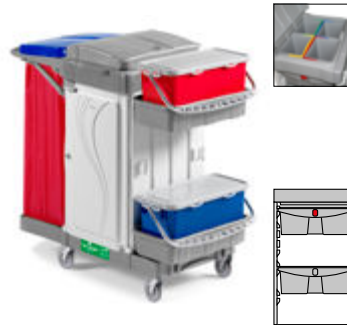

REF.	SIZE (cm) ↓ ↓ ↓
MA3306700U000	118x58x110

Trolley dimensions with closed foldable bag holder
85x58x149 cm

ALPHA 0306702 - collection + storage + soaking



REF.	SIZE (cm) ↓ ↓ ↓
MA0306702UD00	121x58x114

Trolley dimensions with closed foldable bag holder
88x58x149 cm

ALPHA MR3606701 Link-Up system - collection + storage + soaking



REF.	SIZE (cm) ↓ ↓ ↓
MR3606701U000	146x58x112

ALPHA 0706800 Split system - collection + storage + soaking



REF.	SIZE (cm) ↓ ↓ ↓
MA0706800U000	84x58x111

ALPHA 0706804 Split system - collection + storage + soaking



REF.	SIZE (cm) ↓ ↓ ↓
MA0706804U000	94x58x120

Multipurpose trolleys



ALPHA

MORGAN

CHROMED AND RILSAN COATED TROLLEYS

ALPHA 0706806 Split system - collection + storage + soaking



REF.	SIZE (cm)
MA0706806UD00	118x58x120

ALPHA 0706855 Split system - collection + storage + soaking



REF.	SIZE (cm)
MA0706855UD00	94x58x120

ALPHA 3806701 - collection + storage + soaking



REF.	SIZE (cm)
MA3806701U002	120x58x110

ALPHA 8670 - collection + storage + soaking

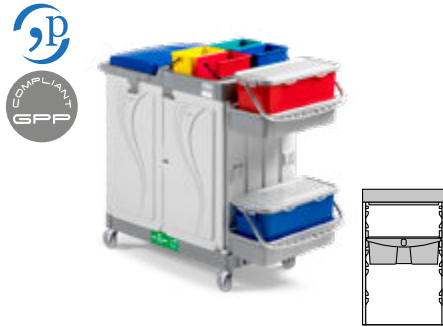

REF.	SIZE (cm)
3000MA8670U00	127x58x114

ALPHA 0806803 Split system - collection + storage + soaking



REF.	SIZE (cm)
MA0806803U000	127x58x114

ALPHA 3806780 - collection + storage + soaking with Click Safe system

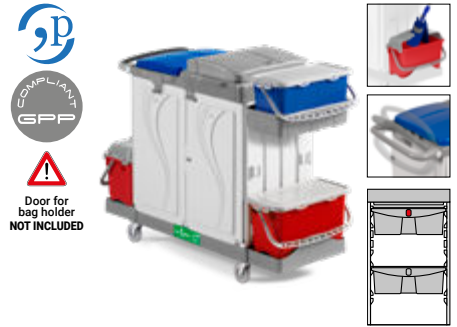

REF.	SIZE (cm)
MA3806780U000	137x58x110

Click Safe system requires the use of the corresponding Click Safe folding mop holder (See the catalog under the line Soaking and Floor Washing Systems - system with pockets)

ALPHA MR0806703 Link-Up system - collection + storage + soaking



REF.	SIZE (cm)
MR0806703U000	146x58x117

ALPHA 5806703 - collection + storage + soaking



REF.	SIZE (cm)
MA5806703U000	127x58x114

ALPHA 0806708 - collection + storage + soaking



REF.	SIZE (cm)
MA0806708U000	127x58x114

⚠ EQUODOSE®, BAGS, COVER FOR BAG HOLDER 120 L AND PEDAL SET NOT INCLUDED

MULTIPURPOSE TROLLEYS



ALPHA

MORGAN

CHROMED AND RILSAN COATED TROLLEYS

ALPHA 0806819 Split system - collection + storage + soaking



REF.	SIZE (cm)
MA0806819U000	125x65x118

ALPHA 3806719 - collection + storage + soaking

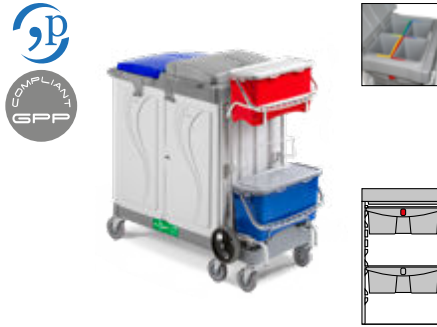

REF.	SIZE (cm)
MA3806719U000	125x65x118

ALPHA 3806809 Split system - collection + storage + soaking



REF.	SIZE (cm)
MA3806809UD00	138x58x120

ALPHA 0806732 - collection + storage + soaking with Click Safe system



REF.	SIZE (cm)
MA0806732UD00	141x58x120

Click Safe system requires the use of the corresponding Click Safe folding mop holder (See the catalog under the line Soaking and Floor Washing Systems - system with pockets)

ALPHA 3806781 - collection + storage + soaking with Click Safe system



REF.	SIZE (cm)
MA3806781UD00	157x58x110

Click Safe system requires the use of the corresponding Click Safe folding mop holder (See the catalog under the line Soaking and Floor Washing Systems - system with pockets)

ALPHA 5806709 - collection + storage + soaking



REF.	SIZE (cm)
MA5806709UD00	138x58x120

ALPHA 3806710 - collection + storage + soaking



REF.	SIZE (cm)
MA3806710UD00	136x58x110

ALPHA MR3806814 Link-Up system + Split - collection + storage + soaking



REF.	SIZE (cm)
MR3806814UD00	146x58x117

ALPHA 3806711 - collection + storage + soaking



REF.	SIZE (cm)
MA3806711UD00	153x58x110

MULTIPURPOSE TROLLEYS

Multipurpose trolleys



ALPHA

MORGAN

CHROMED AND RILSAN COATED TROLLEYS

Metal Free

Specific version, unique in the market, designed to enter freely into the magnetic resonance areas and in the areas where it is not allowed to use any magnetizable equipment.

Products partly made with plastic components certified PSV - Second Life Plastic.



ALPHA METAL FREE 0236704 - storage + soaking



REF.	SIZE (cm)
MX0236704U000	85x58x112

ALPHA METAL FREE 3336700 - collection + storage + soaking

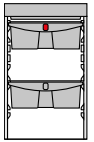

REF.	SIZE (cm)
MX3336700U009	118x58x110

Trolley dimensions with closed foldable bag holder 85x58x149 cm



ALPHA

MORGAN

CHROMED AND RILSAN COATED TROLLEYS

Components for Alpha trolleys

Compact base for Alpha trolley

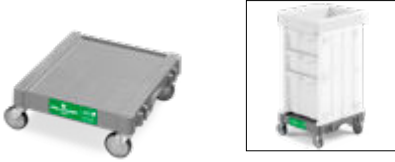

REF.	NOTES	SIZE (cm) ↓ ↓ ↓
P025011U	with wheels ø 100 mm	50x52
P025031U	with rubber wheels ø 125 mm	50x52
P025061U	with wheels ø 125 mm	50x52

Short plastic base for Alpha trolley



REF.	NOTES	SIZE (cm) ↓ ↓ ↓
P059011U	with wheels ø 100 mm	66x52
P059031U	with rubber wheels ø 125 mm	66x52
P059061U	with wheels ø 125 mm	66x52
P159061U	with five ø 125 mm wheels	66x52

Small base for Alpha Metal Free Trolley



REF.	NOTES	SIZE (cm) ↓ ↓ ↓
P059361UX	with rubber wheels ø 125 mm	66x52

Long plastic base for Alpha trolley



REF.	NOTES	SIZE (cm) ↓ ↓ ↓
P066011U	with wheels ø 100 mm	91x52
P066031U	with rubber wheels ø 125 mm	91x52
P066061U	with wheels ø 125 mm	91x52
P166031U	with five ø 125 mm rubber wheels	91x52

Supporting plate with 2 wheels and 2 blocking plugs

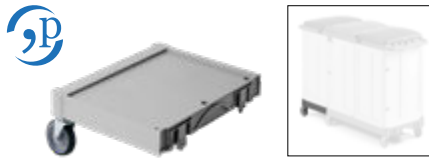

REF.	NOTES
P515010U	with wheels ø 100 mm
P515030U	with rubber wheels ø 125 mm
P515060U	with wheels ø 125 mm

Blocking plug for supporting plastic plate



REF.	NOTES
P1901109U	

Supporting plastic plate with 1 wheel and 2 blocking plugs



REF.	NOTES	SIZE (cm) ↓ ↓ ↓
P075060U	with wheel ø 125 mm	32x48

Supporting plastic plate for Alpha trolleys

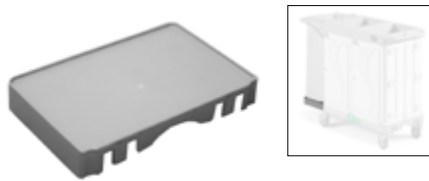

REF.	NOTES	SIZE (cm) ↓ ↓ ↓
P175000U		32x48x7

Base extension for Alpha trolleys and for the bag supporting plastic plate of the Morgan Hotel Elegance trolleys



REF.	NOTES	SIZE (cm) ↓ ↓ ↓
P165000U	without castors	22x48
P065060U	with two wheels ø 125 mm and 2 blockings plugs	22x48

Extension for Alpha trolleys



REF.	NOTES	SIZE (cm) ↓ ↓ ↓
P165001U		13,7x48x11

Multipurpose trolleys



ALPHA

MORGAN

CHROMED AND RILSAN COATED TROLLEYS

Vertical frame with reinforcement, 2 sides with T-plugs, complete with screws

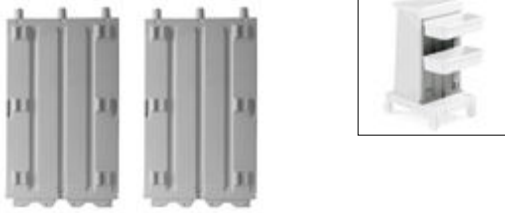

REF. NOTES

P2031102U

Vertical frame with reinforcement, 1 smooth side + 1 side for T-plugs, complete with screws

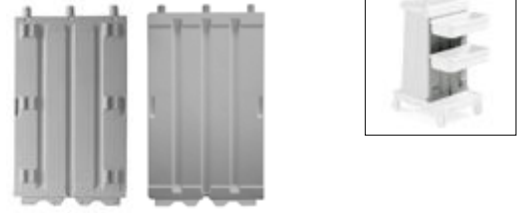

REF. NOTES

P2031103U

For trolleys with foldable bagholder and side baskets

Reinforced vertical frame, 1 side with slides + 1 side for T-plugs, complete with screws and plugs

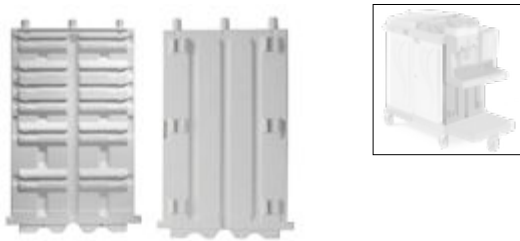

REF. NOTES

P2039908E

Vertical frame, 1 side with slides + 1 side for T-plugs, complete with screws and plugs

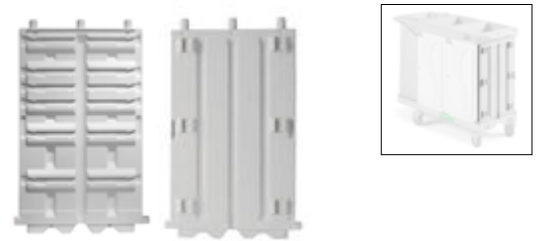

REF. NOTES

P2039903E

Vertical frame, 1 side with slides + 1 side for T-plugs, with reinforcements, complete with screws and plugs for Alpha Metal Free trolley

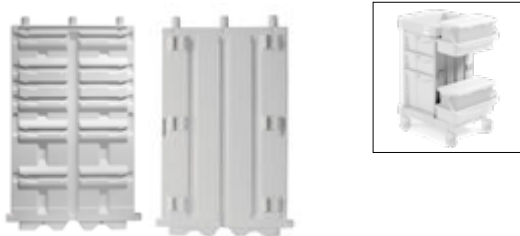

REF. NOTES

P2039910EX

Vertical frame, 2 sides with slides, complete with screws and plugs

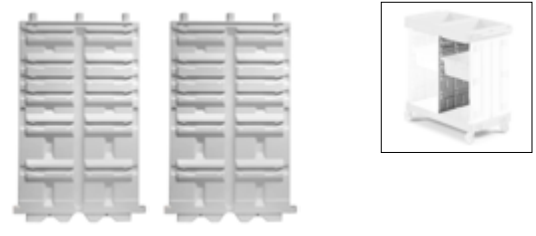

REF. NOTES

P2039904E

Vertical Frame, 1 smooth side + 1 side for T-plugs, complete with screws and plugs

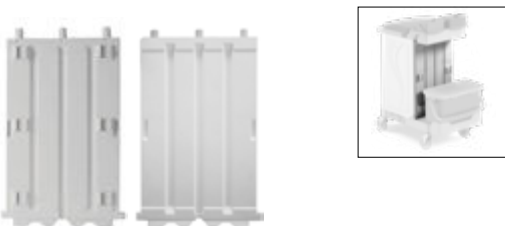

REF. NOTES

P2039906E

Vertical frame with reinforcement, 1 smooth side + 1 side for T-plugs, complete with screws

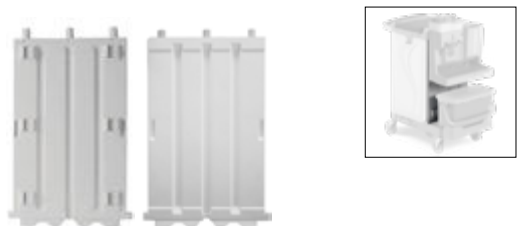

REF. NOTES

P2039909E

MULTIPURPOSE TROLLEYS



ALPHA

MORGAN

CHROMED AND RILSAN COATED TROLLEYS

Quick connection kit Link-Up (4 pcs)

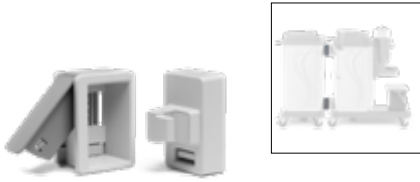

REF.	NOTES
0000SM00617	

Set of T-shaped closing plugs for vertical frames (6 pcs)



REF.	NOTES
0000SM00163	dark grey
0000SM00165	light grey

Fixed side wall with fixing pins



REF.	NOTES
P3059953E	

Fixed side wall with fixing inserts for Alpha Metal Free trolley



REF.	NOTES
P3059953EX	

Right door with fixing pins



REF.	NOTES
P3059954E	

Right door with fixing pins for Alpha Metal Free



REF.	NOTES
P3059954EX	

Left door with fixing pins

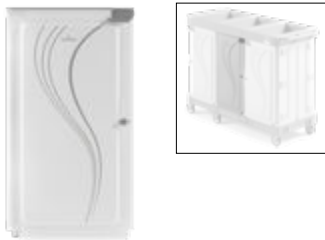

REF.	NOTES
P3059974E	

Door for 150l waste bag holder with fastening pins



REF.	NOTES
P3909952E	

Set walls, right and left, for Alpha with Split system



REF.	NOTES
P3059967E	

Door for Alpha bag holder with Split system



REF.	NOTES
P2059963E	

Central plastic basket (female-female version) with plugs



REF.	NOTES
P2199906U	internal sizes 31x48x8 cm

Central plastic basket (male-female version) with screws and plugs

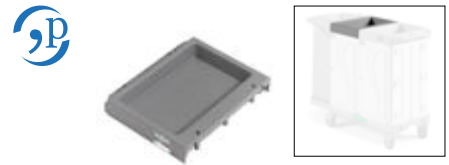

REF.	NOTES
P2199907U	internal sizes 31x48x8 cm

Multipurpose trolleys



ALPHA

MORGAN

CHROMED AND RILSAN COATED TROLLEYS

Central basket (female-female version) with divider and plugs



REF.	NOTES
P2199926U	with a grey cover
P2199926UT	with transparent cover
P2199936U	with 2 grey covers
P2199936UT	with 2 transparent covers

Central basket (male-female version) with divider and plugs

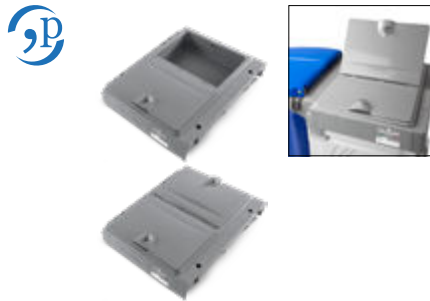

REF.	NOTES
P2199927U	with a grey cover
P2199927UT	with transparent cover
P2199937U	with 2 grey covers
P2199937UT	with 2 transparent covers

Central ring for 4 lt buckets for Alpha Metal Free trolley complete with lockable cover, 2 soft-close pistons and 2 short supports for hooks and clips



REF.	NOTES
P3199903UX	for trolleys with door

Central ring for 4l buckets complete with lockable coloured cover, 2 soft-close pistons and 2 short supports for hooks and clips



REF.	NOTES
P3199903U	for trolleys with door
P3199903UA	for trolleys with door
P3199903UB	for trolleys with door
P3199903UC	for trolleys with door
P3199903UF	for trolleys with door
P4199903U	for trolleys without door
P4199903UA	for trolleys without door
P4199903UB	for trolleys without door
P4199903UC	for trolleys without door
P4199903UF	for trolleys without door

Central ring for 8l buckets complete with lockable coloured cover, 2 soft-close pistons and 2 short supports for hooks and clips

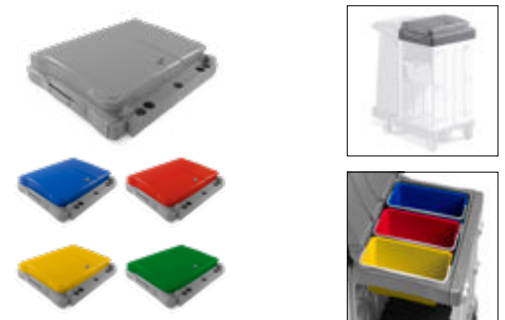

REF.	NOTES
P3199905U	
P3199905UA	
P3199905UB	
P3199905UC	
P3199905UF	

Side plastic basket

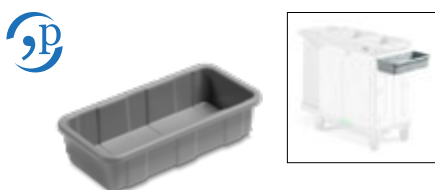

REF.	NOTES
P1191100U	internal sizes 22x49x11,5 cm

Upper basket

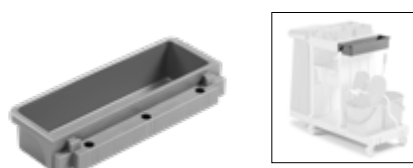

REF.	NOTES
P1199900U	internal sizes 14x49,5x11 cm

Closing profile for central basket and central bag holder, with screws and plugs

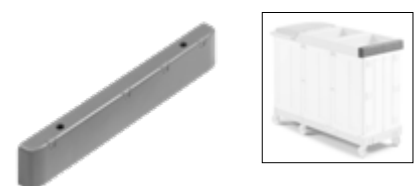

REF.	NOTES
P2909920U	

MULTIPURPOSE TROLLEYS



ALPHA

MORGAN

CHROMED AND RILSAN COATED TROLLEYS

Closing profile for central basket complete with screws and plugs for Alpha Metal Free trolley



REF.	NOTES
P2909920UX	

Closing profile with push-grip for central basket and central bag holder complete with screws and plugs



REF.	NOTES
P2909921U	

Closing profile with push-grip for central basket complete with screws and plugs for Alpha Metal Free trolley



REF.	NOTES
P2909921UX	

Closing profile for vertical frame complete with screws and plugs



REF.	NOTES
P2909960U	

Covering



REF.	NOTES
P1909967U	for fixed bag holder 120 lt
P1909968U	for bag holder 150 lt, foldable bag holder 120 lt and profile

120 lt waste bag holder, with 2 fixed dustpan hooks, 2 handle clips and 2 Uni-Move clips

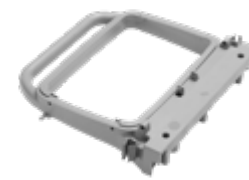

REF.	NOTES
P8161110U	female version
P8161111U	male version

120l waste bag holder for Alpha Metal Free trolley, with 2 fixed dustpan hooks, 2 handle clips and 2 Uni-Move clips

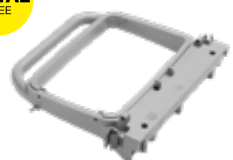

REF.	NOTES
P8161111UX	male version

120l waste bag holder with tray, with 2 fixed dustpan hooks, 2 handle clips, 2 Uni-Move clips, screws and plugs

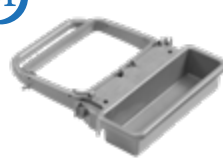

REF.	NOTES
P8161112U	

Folding 120l waste bag holder, with bag retaining hooks, 2 fixed dustpan hooks, 1 handle clip, 2 Uni-Move clips, screws and plugs



REF.	NOTES
P8161113U	
P8161115U	for trolleys with central frame

150 lt waste bag holder, with 2 Uni-Move clips, 2 long supports with sign hook, 2 pistons, screws and plugs for Alpha 7103 trolley

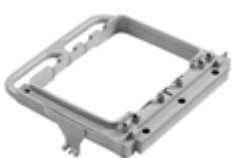

REF.	NOTES
P8169900U	female version
P8169901U	male version

150 lt bag holder for Alpha standard and 90 lt for Alpha with Split system, male version, with two Uni-Move hooks, 2 long supports with sign hooks, 2 pistons, screws and plugs



REF.	NOTES
P8169905U	

150 lt bag holder for Alpha standard and 90 lt for Alpha with Split system, with adjustable push handle, male version, with two Uni-Move hooks, 2 long supports with sign hooks, 2 pistons, screws and plugs



REF.	NOTES
P8269907U	

MULTIPURPOSE TROLLEYS

Multipurpose trolleys



ALPHA

MORGAN

CHROMED AND RILSAN COATED TROLLEYS

Central bag holder 150 lt

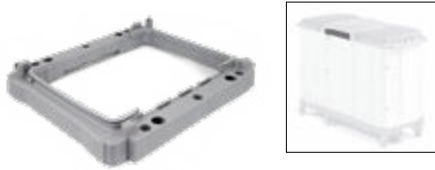

REF.	NOTES
P8169903U	female/female version
P8169904U	male/female version

Set of 2 bag holders 150 Lt complete with screws and plugs

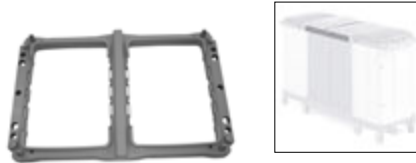

REF.	NOTES
P8169906U	

Rilsan 70l waste bag holder for mounting on vertical frame



REF.	NOTES
R2060031	

Stainless steel holder for 4 lt buckets to be applied to 150 Lt bag holder

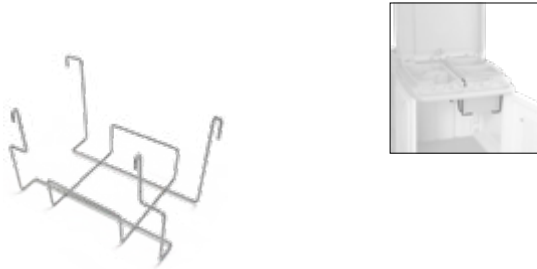

REF.	NOTES
I1050072	

DUO PRO kit



REF.	NOTES	
0020SE2742U		
0000SE0717UA	17l plastic mop bucket, grey with blue handle	1 pc.
0000SE0725UB	Grey plastic bucket 25L with red handle	1 pc.
21040U	DUO PRO - lever plastic wringer	1 pc.
P165002U	Base extension for Duo Pro system	1 pc.
R2050071	Rilsan coated bucket holder for Duo Pro kit	1 pc.

HANDY - bin 70 L with drain plug, wheels and bag stretcher



REF.	NOTES	SIZE (cm)
P391070E	with push-bar	51,5x56x86 ↓ ↓ ↓
P291070E	without push-bar	37x56x71

Advised bag size: 75x110 cm

Cover set complete with rubber lace, cage for deodorant pills and screws



REF.	NOTES
P290068E	

Assembling kit to fix Handy bin to Alpha vertical frame



REF.	NOTES
0000SM00610	

MULTIPURPOSE TROLLEYS



ALPHA

MORGAN

CHROMED AND RILSAN COATED TROLLEYS

Plastic shelf for AlphaSplit

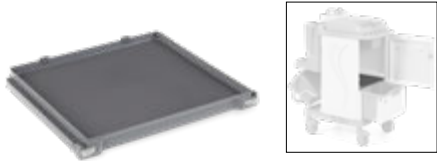

REF.	NOTES
P2229914U	

33 Lt plastic drawer with lock for Alpha with Split system



REF.	NOTES	CAPACITY (L)
P2229913U	interior dimensions 34x41x24 cm	33

Bag holder insert with storage compartment for Alpha with Split system



REF.	NOTES
P1909966U	

Bag holder insert with storage compartment and one divider for AlphaSplit



REF.	NOTES
P2909966U	

Bag holder insert with storage compartment and two dividers for Alpha with Split system



REF.	NOTES
P3909966U	

Set of plastic shelves (2 pcs)

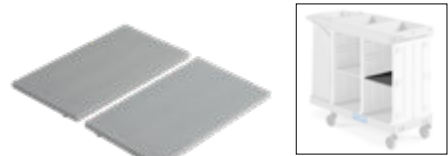

REF.	NOTES	SIZE (cm)
P1229900U		21,5x37,5x1,5

Plastic sliding drawer without locking key



REF.	NOTES	CAPACITY (L)	SIZE (cm)
P1229909U	internal dimensions 41x34x9,5 cm	10	46,5x37,5x11
P1229906U	internal dimensions 40,5x34x16 cm	22	46,5x37,5x17
P1229907U	internal dimensions 40x34x33,5 cm	40	46,5x37,5x35

Plastic sliding drawer with locking key



REF.	NOTES	CAPACITY (L)	SIZE (cm)
P2229909U	internal dimensions 41x34x9,5 cm	10	46,5x37,5x11
P2229906A	internal dimensions 40,5x34x16 cm	22	46,5x37,5x17
P2229906B	internal dimensions 40,5x34x16 cm	22	46,5x37,5x17
P2229906U	internal dimensions 40,5x34x16 cm	22	46,5x37,5x17
P2229907U	internal dimensions 40x34x33,5 cm	40	46,5x37,5x35

Plastic sliding drawer without lock for Alpha Metal Free trolley



REF.	NOTES	CAPACITY (L)	SIZE (cm)
P1229906UX	internal dimensions 40,5x34x16 cm	22	46,5x37,5x17
P1229907UX	internal dimensions 40x34x33,5 cm	40	46,5x37,5x35

Plastic sliding drawer with lock for Alpha Metal Free trolley



REF.	NOTES	CAPACITY (L)	SIZE (cm)
P2229906UX	internal dimensions 40,5x34x16 cm	22	46,5x37,5x17
P2229907UX	internal dimensions 40x34x33,5 cm	40	46,5x37,5x35

Multipurpose trolleys



ALPHA

MORGAN

CHROMED AND RILSAN COATED TROLLEYS

Plastic lift for buckets, with holes for bottles, fitting drawers 22 and 40 L



REF. **P1909937U** NOTES

Rilsan coated wringer support complete with screws



REF. **R1040010** NOTES

Rilsan coated fixing set for Fred trolley



REF. **0000SM00606** NOTES

Plastic cover for Click Safe system



REF. **P190360U** NOTES SIZE (cm)
↓ ↓ ↓
55x23x12

Rilsan coated bucket holder with ø 80 mm wheel for 10/20 lt buckets, fitting the base of the Alpha trolleys



REF. **R2200045** NOTES

Rilsan coated trolley kit with wheels ø 200 mm with trolley locking device, for Top-Down buckets 10 and 20 lt



REF. **R3030162** NOTES SIZE (cm)
↓ ↓ ↓
32x60x94

Fitting Alpha trolleys - Recommended with supporting plate cod. P065060U

Rilsan coated bucket holder for buckets 10 and 20 L fitting Morgan vertical frame and Alpha trolley



REF. **R2200040** NOTES

Bucket holder in Rilsan for 10/20 L buckets

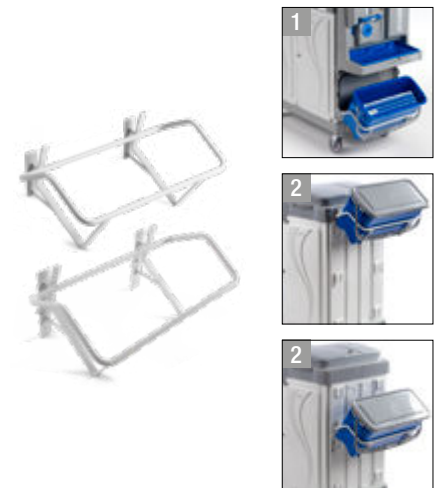

REF. **R1200042** NOTES
1. can be applied to the bottom position of the vertical frame
R1200044 2. can be applied to the top and middle position of the vertical frame

MULTIPURPOSE TROLLEYS



ALPHA

MORGAN

CHROMED AND RILSAN COATED TROLLEYS

Accessories for Alpha trolleys

Plastic rising support for basket art. P1191100U

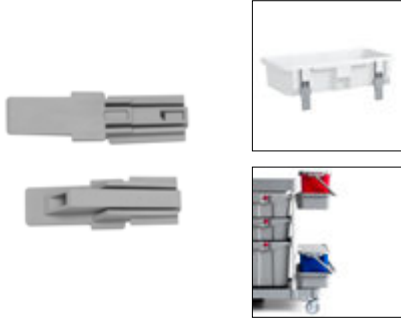

REF. NOTES

P1901112U

Divider for plastic bag holder 120 L



REF. NOTES

P206020U 2x60 L
P206030U 1x40 L + 1x80 L
P206040U 3x40 L

Plastic divider with square shaped insert for bag holder 120 L



REF. NOTES

P306020U 2x60 L and 20 L square shaped insert
P406020U 2x60 L and two 20 L square shaped inserts

For Alpha, Emotion range bag holders and bag holder code P906010U, Morgan range

Square plastic support 20 L for the divider of bag holder 120 L



REF. NOTES

P1909957U

For Alpha, Emotion range bag holders and bag holder code P906010U, Morgan range - Use recommended with net bags, code 0000AT0210

Divider for bag holder 150 L



REF. NOTES

P2909912U

Square plastic support 20 L for bag holder 150 L

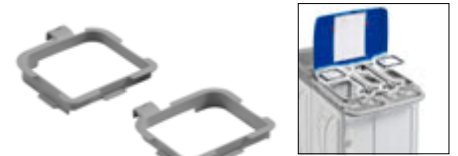

REF. NOTES

P1909926U with right connection
P1909927U with left connection

It is suggested the use of the specific net bags for washing art. 0000AT0210

Plastic divider 3x20 L for bag holder 150 L



REF. NOTES

P1909914U

It is suggested the use of the specific net bags for washing art. 0000AT0210

Plastic sliding tray with slide out limiter and key

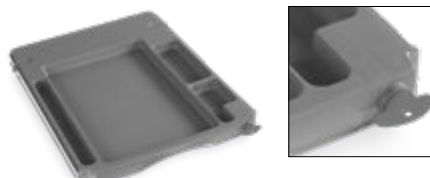

REF. NOTES

P3229915U

Set of 1 big divider 39 cm + 1 medium divider 32 cm for plastic sliding drawer 22 L



REF. NOTES

0000SM00213U

MULTIPURPOSE TROLLEYS

Multipurpose trolleys



ALPHA

Set of 1 big divider 39 cm + 3 small dividers 16 cm for plastic sliding drawer 22 L

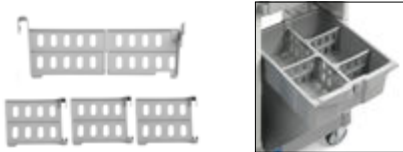

REF.	NOTES
0000SM00214U	

Pierced plastic sieve with high border for mop soaking fitting drawers 10, 22 and 40 lt

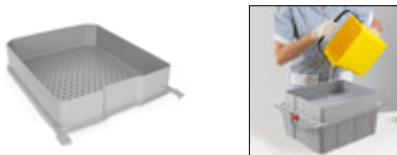

REF.	NOTES	SIZE (cm) ↓ ↓ ↓
P1909961U		46,5x36,5x10

Ideal for a uniform distribution of the cleaning solution
- For a quick pre-soaking (max 15 minutes)

Pedal set for Alpha trolleys with short base and closed bag holder 150 L



REF.	NOTES
P3909915U	for base with wheels ø 100 mm
P3909918U	for base with rubber wheels ø 125 mm
P3909962U	for base with wheels ø 125 mm

Only for bases with 4 wheels

Plastic cover for bag holder 120 L with storage room, check-list holder and lock



REF.	NOTES
P291920UA	
P291920UB	
P291920U	

Please, require also no. 2 shock absorbing pistons art. P190908U for a perfect soft closing

MORGAN

Plastic divider for drawer 10 L



REF.	NOTES
0000SM00227D	9 compartments
0000SM00228D	12 compartments

Plastic cover for drawers 10, 22 and 40 lt



REF.	NOTES
P1909933U	

Plastic cover for bag holder 120 L



REF.	NOTES
P291918A	
P291918B	

Please, require also no. 2 shock absorbing pistons art. P190908U for a perfect soft closing

Plastic cover for bag holder 150 L with check-list holder



REF.	NOTES
P2909946A	
P2909946B	

CHROMED AND RILSAN COATED TROLLEYS

Pierced plastic sieve for mop soaking fitting drawers 10, 22 and 40 lt

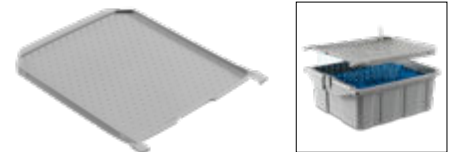

REF.	NOTES
P1909925U	

Ideal for a uniform distribution of the cleaning solution
- For a quick pre-soaking (max 15 minutes)

Pedal kit for Alpha trolleys with large, mini or supporting plate with 2 wheels and 150 lt bag holder



REF.	NOTES
P2909915U	for base with wheels ø 100 mm
P2909918U	for base with rubber wheels ø 125 mm
P2909962U	for base with wheels ø 125 mm

Only for bases with 4 wheels

Plastic cover for bag holder 120 L with check-list holder



REF.	NOTES
P291919A	
P291919B	
P291919T	

Please, require also no. 2 shock absorbing pistons art. P190908U for a perfect soft closing

Plastic cover for bag holder 150 L with check-list holder, storage room and removable locking key



REF.	NOTES
P2909955A	
P2909955B	

Please, require also no. 2 shock absorbing pistons art. P190908U for a perfect soft closing



ALPHA

MORGAN

CHROMED AND RILSAN COATED TROLLEYS

Plastic cover for bag holder 150 L with check-list holder, storage room and removable double locking key

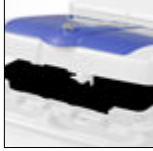

REF. NOTES

P3909955A
P3909955B

Please, require also no. 2 shock absorbing pistons art. P190908U for a perfect soft closing

Plastic cover for central bag holder 150 L

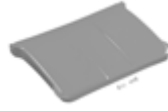

REF. NOTES

P2919943U

Please, require also no. 2 shock absorbing pistons art. P190908U for a perfect soft closing

Plastic cover for 70-litre bagholder complete with check-list holder



REF. NOTES

P190916A

Shock absorbing piston for a soft closing of the cover



REF. NOTES

P190908U

Plastic mop holder fitting Alpha base



REF. NOTES

P1909948U

Tablet holder support for the Alpha vertical frame



REF. NOTES

0000SM00401

For tablet sizes 7 to 10.1 inches (20 to 31 cm)

Fitting for Uni-Connect system, can be applied to Alpha fixed side wall



REF. NOTES

0000SM00404

Learn more about Uni-Connect in the glass and surfaces section

Fitting for Uni-Connect system, can be applied to Alpha vertical frame



REF. NOTES

0000SM00405 right
0000SM00406 left

Learn more about Uni-Connect in the glass and surfaces section

PEG KIT - kit for attaching OneFred on Alpha trolleys complete with mop holder



REF. NOTES

0000SM00298

Multipurpose trolleys



ALPHA

MORGAN

CHROMED AND RILSAN COATED TROLLEYS

PEG KIT - kit for attaching OneFred on Alpha trolleys



REF.	NOTES
0000SM00301	

Plastic bin 12 L with metal handle and cover with locking key



REF.	NOTES	SIZE (cm)
0000C02012U		21x26x36

Thanks to its locking key, it is possible to transport chemical and/or toxic products inside the bin safely

POCKET - foldable metal trolley for Top-Down® buckets 10 and 20 lt



REF.	NOTES
V2030122	



ALPHA

MORGAN

CHROMED AND RILSAN COATED TROLLEYS



Morgan multipurpose trolleys satisfy any cleaning request. Thanks to an intelligent combination of polypropylene and Rilsan coated components they are very strong and have a long life. Quick and easy assembling and versatility are the main features of these trolleys. They can be used both with the traditional wet mopping systems with buckets and wringer and with the more recent wet mopping system with pre-soaked mops.

Morgan trolleys have been produced with some components certified "Plastic Second Life", that is to say made of recycled plastic materials, according to the Green Public Procurements environmental policies.



Collection and storage line

MORGAN 1000 - collection + storage



REF.	SIZE (cm)
0000MP1000A	96x61x109

MORGAN 2050 - collection + storage



REF.	SIZE (cm)
0000MP2050A	96x61x104

MORGAN 3000 - collection + storage



REF.	SIZE (cm)
0000MP3000A	110x61x107

Wet mopping line

MORGAN 1040 - collection + storage + washing



REF.	SIZE (cm)
0000MP1040A	129x67x113

WRINGER VERSIONS

BOOST - flat wringer	PUNTO - roller wringer
TROLLEY REF. 0071MP1040A	TROLLEY REF. 0022MP1040A

MORGAN 1050 - collection + washing



REF.	SIZE (cm)
0000MP1050A	96x67x113

WRINGER VERSIONS

BOOST - flat wringer	PUNTO - roller wringer
TROLLEY REF. 0071MP1050A	TROLLEY REF. 0022MP1050A

MORGAN 1060 - collection + storage + washing



REF.	SIZE (cm)
0000MP1060A	106x67x113

WRINGER VERSIONS

BOOST - flat wringer	PUNTO - roller wringer
TROLLEY REF. 0071MP1060A	TROLLEY REF. 0022MP1060A

⚠ BAGS AND COVERS NOT INCLUDED

MULTIPURPOSE TROLLEYS

Multipurpose trolleys



ALPHA

MORGAN

CHROMED AND RILSAN COATED TROLLEYS

MORGAN 2010 - collection + storage + washing



REF.	SIZE (cm) ↓ ↓ ↓
0000MP2010A	129x67x113

WRINGER VERSIONS

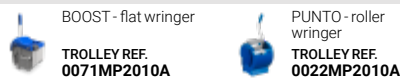

BOOST - flat wringer
TROLLEY REF. 0071MP2010A

PUNTO - roller wringer
TROLLEY REF. 0022MP2010A

MORGAN 2150 - collection + storage + washing



REF.	SIZE (cm) ↓ ↓ ↓
0000MP2150A	96x61x113

Complete trolley sizes with OneFred 148 x65x113 cm

MORGAN 3010 - collection + storage + washing



REF.	SIZE (cm) ↓ ↓ ↓
0000MP3010A	139x67x107

WRINGER VERSIONS

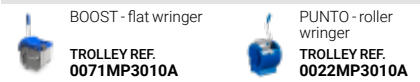

BOOST - flat wringer
TROLLEY REF. 0071MP3010A

PUNTO - roller wringer
TROLLEY REF. 0022MP3010A

MORGAN 3060 - collection + storage + washing



REF.	SIZE (cm) ↓ ↓ ↓
0000MP3060A	139x63x107

MORGAN 3080 - collection + washing



REF.	SIZE (cm) ↓ ↓ ↓
0000MP3080A	110x67x109

WRINGER VERSIONS

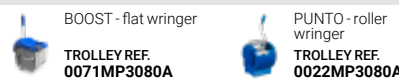

BOOST - flat wringer
TROLLEY REF. 0071MP3080A

PUNTO - roller wringer
TROLLEY REF. 0022MP3080A

MORGAN 4010 - collection + storage + washing



REF.	SIZE (cm) ↓ ↓ ↓
0000MP4010A	139x67x107

WRINGER VERSIONS

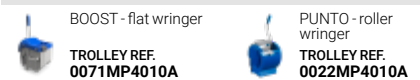

BOOST - flat wringer
TROLLEY REF. 0071MP4010A

PUNTO - roller wringer
TROLLEY REF. 0022MP4010A

Top-Down® line

MORGAN TOP-DOWN® MIDI 8010 - collection + storage + soaking



REF.	SIZE (cm) ↓ ↓ ↓
0000MP8010A	116x62x116

MORGAN TOP-DOWN® MAXI 8020 - collection + storage + soaking



REF.	SIZE (cm) ↓ ↓ ↓
0000MP8020A	127x62x115

MORGAN TOP-DOWN® MIDI 7010 - collection + storage + soaking



REF.	SIZE (cm) ↓ ↓ ↓
0000MP7010A	115x61x116

⚠ BAGS AND COVERS NOT INCLUDED

MULTIPURPOSE TROLLEYS



ALPHA

MORGAN

CHROMED AND RILSAN COATED TROLLEYS

MORGAN TOP-DOWN® MAXI 7020 -
collection + storage + soaking



REF.	SIZE (cm)
0000MP7020A	127x61x115

Components for Morgan trolleys

Short plastic base for Morgan trolley



REF.	NOTES	SIZE (cm)
P202001A	with wheels ø 100 mm	92x55
P202002A	with wheels ø 125 mm	92x55
P202017A	with rubber wheels ø 125 mm	92x55

Long plastic base complete with 5 wheels for Morgan trolley



REF.	NOTES	SIZE (cm)
P202050A	with wheels ø 100 mm	105x55
P202053A	with wheels ø 125 mm	105x55
P202067A	with rubber wheels ø 125 mm	105x55

Plastic base complete with 5 wheels for Morgan Security trolley



REF.	NOTES	SIZE (cm)
P402050U	with wheels ø 100 mm	105x55
P402053U	with wheels ø 125 mm	105x55
P402067U	with rubber wheels ø 125 mm	105x55

Rilsan coated vertical frame complete with screws for Morgan trolley



REF.	NOTES
R1030010	

Rilsan coated vertical frame with double connection for Morgan trolley art. 0000MP1030U



REF.	NOTES
R1030147	

Rilsan coated vertical frame for Morgan trolley art. 0000MP4010A



REF.	NOTES	SIZE (cm)
R1030137		46x89

Rilsan coated shaped vertical frame for Morgan trolley art. 0000MP1050A



REF.	NOTES
R1030125	

Rilsan 5-bar vertical frame for Morgan Top-Down®



REF.	NOTES
R1030103	

Rilsan coated vertical frame with 1 bar for Morgan Security trolley, 1 mt high



REF.	NOTES
R1030040	

⚠ BAGS AND COVERS NOT INCLUDED

MULTIPURPOSE TROLLEYS

Multipurpose trolleys



ALPHA

Rilsan coated vertical frame with 3 bars for Morgan Security trolley, 1 mt high



REF.	NOTES
R1030134	where to fix the baskets art. P019004U

MORGAN

Small plastic basket for Morgan Security trolley



REF.	NOTES
P019004U	internal sizes 26x44x11 cm

CHROMED AND RILSAN COATED TROLLEYS



Set of 2 plastic slots for sliding drawers complete with fixing clips for Morgan Security trolley



REF.	NOTES
P2909934E	



Small central plastic basket for Morgan trolley



REF.	NOTES
P119001A	internal sizes 26,5x44x11 cm 
P119001U	internal sizes 26,5x44x11 cm 

Side plastic basket for Morgan trolley



REF.	NOTES
P119002A	internal sizes 18,5x49,5x11 cm 
P119002U	internal sizes 18,5x49,5x11 cm 

Big central plastic basket with 6 hooks



REF.	NOTES
P119003A	internal sizes 37,5x48,5x11 cm 

Bag holder 120 lt without reinforcements, with push-bar, bag-stretchers, bag fixing hooks and 2 handle holders



REF.	NOTES
P906010U	

Plastic bag holder 120 lt with push-bar, bag-stretchers and reinforcements



REF.	NOTES
P816010U	

Plastic bag holder 2x60 lt with push-bar, bag-stretchers and reinforcements



REF.	NOTES
P516010U	

Plastic bag holder 1x40 lt + 1x80 lt with push-bar, bag-stretchers and reinforcements



REF.	NOTES
P716010U	

Plastic bag stretcher for bag holder



REF.	NOTES
P190920U	for art. P816010U and P906010U
P190921U	for art. P516010U and P716010U

Rilsan coated bag holder 120 lt with bag-stretcher for Morgan trolley



REF.	NOTES
R2060010	

MULTIPURPOSE TROLLEYS



Multipurpose trolleys

ALPHA

Rilsan coated bag holder 2x70 lt for Morgan trolley



REF.	NOTES
R3659	

Rilsan coated support for buckets 10 lt and 20 lt for Morgan trolleys art. 0000MP8010A and 0000MP8020A



REF.	NOTES
R2200120	

Supporting plastic plate for bucket 10 and 20 lt fitting Morgan base

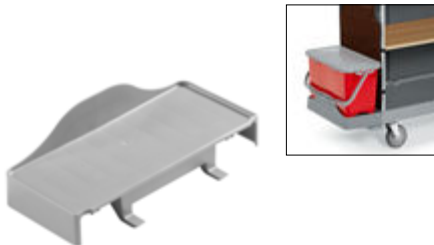

REF.	NOTES	SIZE (cm)
P064000A		22x48x15
P064000U		22x48x15

Plastic basin 35 lt



REF.	NOTES
3641A	

MORGAN

Rilsan coated bucket holder for bucket fitting vertical frame Morgan trolley



REF.	NOTES
R1200020	for bucket 28 lt

Rilsan coated wringer support complete with screws



REF.	NOTES
R1040010	

Rilsan coated trolley for Top-Down® buckets 10 and 20 L, with wheels ø 170 mm

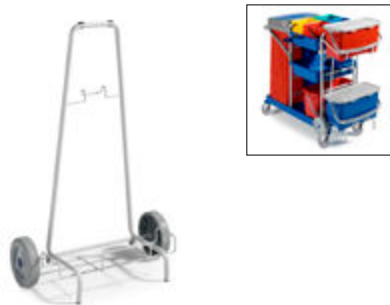

REF.	NOTES
R2030120	Fitting Morgan trolleys art.no. 0000MP8010A and 0000MP8020A

Pierced plastic sieve for basin 35 lt



REF.	NOTES
3642	

CHROMED AND RILSAN COATED TROLLEYS

Rilsan coated bucket holder for buckets 10 and 20 lt fitting vertical frame Morgan Security trolley



REF.	NOTES
R2200041	

Supporting plastic plate fitting Morgan base



REF.	NOTES
P074000A	
P074000U	

Available on request with 1 wheel

Plastic cabinet with locking key for Morgan trolley art. 0000MP4010A

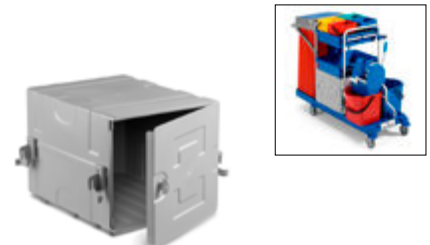

REF.	NOTES	SIZE (cm)
P1220203E		49x39x34



ALPHA

MORGAN

CHROMED AND RILSAN COATED TROLLEYS

Accessories for Morgan trolleys

Divider for plastic bag holder 120 L



REF.	NOTES
P206020U	2x60 L
P206030U	1x40 L + 1x80 L
P206040U	3x40 L

Plastic divider with square shaped insert for bag holder 120 L



REF.	NOTES
P306020U	2x60 L and 20 L square shaped insert
P406020U	2x60 L and two 20 L square shaped inserts

For Alpha, Emotion range bag holders and bag holder code P906010U, Morgan range

Square plastic support 20 L for the divider of bag holder 120 L



REF.	NOTES
P1909957U	For Alpha, Emotion range bag holders and bag holder code P906010U, Morgan range - Use recommended with net bags, code 0000AT0210

Chromed side basket



REF.	NOTES
3655	Fitting Morgan trolleys with 2 hooks art.no. 0000SM00113U

POCKET - foldable metal trolley for Top-Down® buckets 10 and 20 lt



REF.	NOTES
V2030122	

Shock absorbing piston for a soft closing of the cover



REF.	NOTES
P190908U	

Plastic cover for bag holder 120 L



REF.	NOTES
P291918A	
P291918B	

Please, require also no. 2 shock absorbing pistons art. P190908U for a perfect soft closing

Plastic cover for bag holder 120 L with check-list holder



REF.	NOTES
P291919A	
P291919B	
P291919T	

Please, require also no. 2 shock absorbing pistons art. P190908U for a perfect soft closing

Plastic cover for bag holder 120 L with storage room, check-list holder and lock

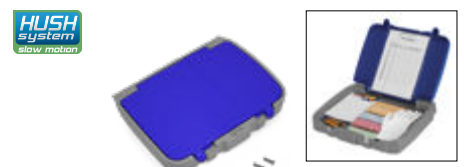

REF.	NOTES
P291920UA	
P291920UB	
P291920U	

Please, require also no. 2 shock absorbing pistons art. P190908U for a perfect soft closing



ALPHA

Plastic cover for bag holder 120 L art. 3657-R2060010- I2060010 and R2060060



REF.	NOTES
3639A	
3639B	

MORGAN

Plastic cover for bag holder 2x70L ref. 3637, 3659, I2060020 and R206005



REF.	NOTES
3644A	
3644B	

CHROMED AND RILSAN COATED TROLLEYS

Rilsan coated broom/mop head holder support complete with fixing set



REF.	NOTES
R2050010	

Plastic broom/mop holder support for Morgan trolleys



REF.	NOTES
P119008U	

PEG KIT - kit for attaching OneFred on Morgan trolleys complete with mop holder



REF.	NOTES
0000SM00297	

PEG KIT - kit for attaching OneFred on Morgan trolleys



REF.	NOTES
0000SM00300	

Kit to fix Equodose on Morgan trolleys



REF.	NOTES
0000SM00613	

Multipurpose trolleys



ALPHA

MORGAN

CHROMED AND RILSAN COATED TROLLEYS

Teddy trolleys

TEDDY 8080 - collection + storage



REF.	SIZE (cm) ↓ ↓ ↓
8080X	82x51x105

TEDDY 8090 - collection + washing



REF.	SIZE (cm) ↓ ↓ ↓
8090X	100x66x105

TEDDY 8098 - collection + storage + washing



REF.	SIZE (cm) ↓ ↓ ↓
8098X	134x66x110

TEDDY 8200 - collection + storage + washing



REF.	SIZE (cm) ↓ ↓ ↓
8200X	82x72x105

Components for Teddy trolleys

Chromed base with wheels ø 100 mm and bumpers for Teddy trolleys



REF.	NOTES
30300CL	for art. 8090X e 8098X
C30075CL	for art. 8089X
C30139CL	for art. 8200X
C8201CL	for art. 8080X and 8083X

Chromed vertical frame



REF.	NOTES
8203/2	

Chromed vertical frame for trolley art. 8200X



REF.	NOTES
C30140/2	

Chromed wringer support for trolley art. 8098X



REF.	NOTES
30141	

Chromed basket for Teddy and art. 8076 trolleys



REF.	NOTES	SIZE (cm) ↓ ↓ ↓
8205/2		50x20x13

Chromed bucket holder



REF.	NOTES
8234	

Basket holder for basket art. 3640



REF.	NOTES
8267	

Side plastic basket



REF.	NOTES
3640	internal sizes 23x40x11 cm

Central basket holder for trolley art. 9098X



REF.	NOTES
30302	

⚠ BAGS AND COVERS NOT INCLUDED

MULTIPURPOSE TROLLEYS



ALPHA

MORGAN

CHROMED AND RILSAN COATED TROLLEYS

Rod with nuts for Teddy trolleys



REF.	NOTES
3671	

Central plastic basket



REF.	NOTES
8252	for Jumbo Tank and Master - internal dimensions 63x45x7x cm
8253	for Teddy and Jumbo Quadri - internal dimensions 44x45x7 cm
3638	for Jumbo Quick and Mini Jumbo - internal dimensions 43,5x27,5x11 cm

Chromed bag holder 120 lt for Teddy trolleys



REF.	NOTES
3657	

Chromed bag holder 2x70 lt for Teddy trolleys



REF.	NOTES
3659	

Plastic tray for the base of the trolleys art. 8049, Teddy 8090X-8098X and Panda



REF.	NOTES	SIZE (cm)
8227		↓ ↓ ↓ 39,5x59x2,5

Plastic anti-spill tray for bases art. C8201CL, 30300CL and C30139CL

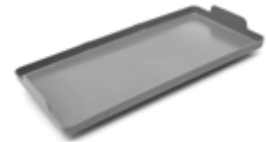

REF.	NOTES
60233U	

Plastic bag fixing clip



REF.	NOTES
8220A	

Plastic flanges with screws for vertical frame fixing



REF.	NOTES
8611U	

Accessories for Teddy trolleys

Plastic cover for bag holder 120 L art. 3657-R2060010-12060010 and R2060060



REF.	NOTES
3639A	
3639B	

Plastic cover for bag holder 2x70L ref. 3637, 3659, 12060020 and R206005



REF.	NOTES
3644A	
3644B	

Chromed broom/mop holder



REF.	NOTES
8213	

Fixing clips for broom/mop holder support (2 pcs)



REF.	NOTES
8225U	



ALPHA

MORGAN

CHROMED AND RILSAN COATED TROLLEYS

Jumbo trolleys

JUMBO TANK 3054 - collection + storage + washing



REF.	SIZE (cm)
3054	↓ ↓ ↓ 142x58x110

JUMBO MASTER 3064 - collection + storage + washing



REF.	SIZE (cm)
3064	↓ ↓ ↓ 113x67x110

JUMBO MASTER 3072 - storage



REF.	SIZE (cm)
3072	↓ ↓ ↓ 84x58x110

JUMBO QUADRI 3080 - collection + storage



REF.	SIZE (cm)
3080	↓ ↓ ↓ 122x58x110

JUMBO QUADRI 3082 - collection + storage



REF.	SIZE (cm)
3082	↓ ↓ ↓ 136x58x110

Available while stocks last

JUMBO QUICK 3090 - collection + storage + washing



REF.	SIZE (cm)
3090	↓ ↓ ↓ 120x66x110

Smart trolleys

MINI JUMBO 3010 - collection + storage



REF.	SIZE (cm)
3010	↓ ↓ ↓ 64x57x110

SMART 7230 - collection + washing



REF.	SIZE (cm)
7230	↓ ↓ ↓ 85x66x115

SMART 7235 - collection + storage



REF.	SIZE (cm)
7235	↓ ↓ ↓ 85x53x105

⚠ BAGS AND COVERS NOT INCLUDED



ALPHA

MORGAN

CHROMED AND RILSAN COATED TROLLEYS

Components for Jumbo trolleys - Ecology

Chromed base with wheels ø 100 mm and bumpers for Jumbo trolley



REF.	NOTES	SIZE (cm) ↓ ↓ ↓
C3629CL	for Jumbo Tank, Master and Quick	77x51
C3605CL	for Jumbo Quadri	51x51
3663CL	for Mini Jumbo	39x50

Chromed vertical frame for Jumbo trolley



REF.	NOTES
3604	

Chromed bag support for Jumbo trolley



REF.	NOTES
3633	

Chromed bag holder 120 lt for Jumbo trolley



REF.	NOTES
3606	

2x70 lt chromed bag holder for Jumbo trolleys



REF.	NOTES
3637	

Chromed basket holder for Jumbo trolley



REF.	NOTES
3615	for basket art. 8252
3624	for basket art. 3638
3607	for basket art. 8253

Tray holder for art. 8252 with handle holder for Jumbo Tank trolley



REF.	NOTES
3611	

Holder for plastic basket art. 3640

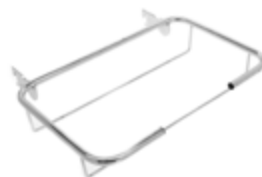

REF.	NOTES
7166	

Side plastic basket



REF.	NOTES
3640	internal sizes 23x40x11 cm

Central plastic basket



REF.	NOTES
8252	for Jumbo Tank and Master - internal dimensions 63x45x7 cm
8253	for Teddy and Jumbo Quadri - internal dimensions 44x45x7 cm
3638	for Jumbo Quick and Mini Jumbo - internal dimensions 43,5x27,5x11 cm

Chromed basket for Jumbo trolley

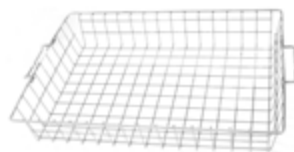

REF.	NOTES	SIZE (cm) ↓ ↓ ↓
3601	for Jumbo Quadri	45x45x11
3610	for Jumbo Master	65x48x11

Chromed basket for Jumbo Master trolley



REF.	NOTES	SIZE (cm) ↓ ↓ ↓
3613		66x23x11

Multipurpose trolleys



ALPHA

MORGAN

CHROMED AND RILSAN COATED TROLLEYS

Chromed rod for basket art. 3613 for Jumbo Master trolley



REF.	NOTES
3614	

Chromed wringer support for Jumbo trolley



REF.	NOTES
3600	

Chromed holder for plastic basket fitting the base of the Jumbo trolley art. 3064



REF.	NOTES
3626	

Chromed basket holder for Ecology trolleys



REF.	NOTES
3647	

Chromed bucket holder for tray art. 8252



REF.	NOTES
3665	

Plastic anti-spill tray for Jumbo trolley



REF.	NOTES
60234	

Plastic flanges with screws for vertical frame fixing



REF.	NOTES
8611U	

PICK-UP - plastic bin 45 L without wheels, complete with cover and screen printed plastic plate



REF.	NOTES	SIZE (cm)
3667A	with image "paper"	51x31,5x30
3667B	with image "metal"	51x31,5x30
3667C	with image "plastic"	51x31,5x30
3667E	with image "non-recyclable waste"	51x31,5x30
3667F	with image "glass"	51x31,5x30
3667G	with image "organic waste"	51x31,5x30

Plastic basin 35 lt



REF.	NOTES
3641A	

MULTIPURPOSE TROLLEYS

Pierced plastic sieve for basin 35 lt



REF.	NOTES
3642	

Set with allen spanner, screws and nuts for Jumbo assembling



REF.	NOTES
8615	



ALPHA

MORGAN

CHROMED AND RILSAN COATED TROLLEYS

Accessories for Jumbo and Ecology trolleys

Plastic cover for bag holder
120 L art. 3657-R2060010-
I2060010 and R2060060



REF.	NOTES
3639A	
3639B	

Plastic cover for bag holder
2x70L ref. 3637, 3659,
I2060020 and R206005



REF.	NOTES
3644A	
3644B	

Chromed broom/mop holder



REF.	NOTES
8213	

Fixing clips for broom/mop
holder support (2 pcs)



REF.	NOTES
8225U	

Panda trolleys

PANDA 7106 - collection + washing



REF.	SIZE (cm)
7106	↓ ↓ ↓ 75x46x122

PANDA 7108 - storage + washing



REF.	SIZE (cm)
7108	↓ ↓ ↓ 66x46x122

PANDA 7200 - collection + washing



REF.	SIZE (cm)
7200	↓ ↓ ↓ 75x65x122

Components for Panda trolleys

Chromed base with 2 wheels ø 80 mm and 2
wheels ø 175 mm for Panda trolley
art. 7106 and 7108



REF.	NOTES
7161CL	

Push-bar for Panda trolleys
art. 7106 and 7108



REF.	NOTES
7155	

Bag holder 120 lt for Panda trolleys
art. 7106 and 7200



REF.	NOTES
7152	

BAGS AND COVERS NOT INCLUDED

Multipurpose trolleys



ALPHA

MORGAN

CHROMED AND RILSAN COATED TROLLEYS

Basket holder for Panda trolleys art. 7106, 7108 and 7200



REF.	NOTES
7151	

Basket holder for Panda trolley art. 7108



REF.	NOTES
7154	

Chromed basket for bottles fitting Panda trolleys art. 7106, 7108 and 7200



REF.	NOTES
7159	

Chromed bag support for Panda trolley art. 7106



REF.	NOTES
7153	

Chromed base with wheels \varnothing 80 mm, 2 with brakes and bumpers, for Panda trolley art. 7200



REF.	NOTES
7157CL	

Chromed push-bar for Panda trolley art. 7200



REF.	NOTES
7156	

Chromed bag support with wheel \varnothing 80 mm for Panda trolley art. 7200



REF.	NOTES
7160CL	

Chromed wringer support for Panda trolleys art. 7200



REF.	NOTES
7163	

Holder for plastic basket art. 3640



REF.	NOTES
7166	

Side plastic basket



REF.	NOTES
3640	internal sizes 23x40x11 cm

Plastic tray for the base of the trolleys art. 8049, Teddy 8090X-8098X and Panda



REF.	NOTES	SIZE (cm)
8227		39,5x59x2,5

Plastic flanges with screws for vertical frame fixing



REF.	NOTES
8611U	

Accessories for Panda trolleys

Plastic bag fixing clip



REF.	NOTES
8220A	

Chromed broom/mop holder



REF.	NOTES
8213	

Fixing clips for broom/mop holder support (2 pcs)



REF.	NOTES
8225U	



A-B PLUS anti-bacterial system



A-B PLUS



A-B PLUS

Safe hygiene and health for everyone!

A-B Plus is a complete cleaning system whose components have been treated with anti-bacterial additives in order to slow down the growth of bacteria, molds and fungi.

This cleaning system uses silver ion technology for microfiber and Zinc Pyrithione for Alpha trolleys and their components.

The anti-bacterial additive, mixed during the production process, is part of the polymeric matrice and penetrates the cell wall of the micro-organism blocking its growth and reproduction functions.

The anti-bacterial treatment can be **guaranteed for the whole life cycle** of the product.

Better hygiene and safety for everyone

- For end users: patients, children, old people, consumers
- For professional people: doctors, nurses, teachers and food operators
- For cleaning operators
- For environment

A sanitization cleaning system for hospitals... and more than that

- Hospitals: both low-risk common areas and high-risk areas, such as operating rooms, infection disease wards, intensive care wards and similar environments
- Nursing homes
- Public facilities: schools, nursery schools, food industries, banks, airports, railway stations



Partially made with plastic components certified "Plastic Second Life"

**100%
recyclable**



Test carried out by EcamRicert Srl according to the ISO 22196:2011 method



Tested by SGS, according to ISO 20743-2013



A-B-PLUS

A-B PLUS

Alpha A-B PLUS trolleys

ALPHA A-B PLUS 0503700 - plastic anti-bacterial trolley



REF.	SIZE (cm)
MZ0503700Z900	118x66x112

ALPHA A-B PLUS 0603700 - plastic anti-bacterial trolley

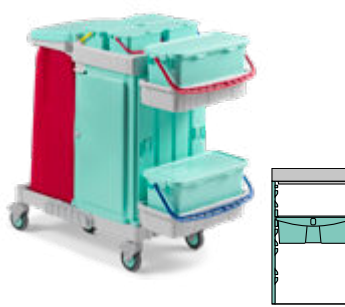

REF.	SIZE (cm)
MZ0603700Z900	118x66x112

ALPHA A-B PLUS 0603706 - antibacterial plastic trolley with Click Safe system

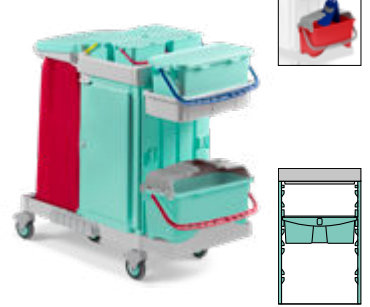

REF.	SIZE (cm)
MZ0603706Z901	118x66x112

Click Safe system requires the use of the corresponding Click Safe folding mop holder (See the catalog under the line Soaking and Floor Washing Systems - system with pockets)

ALPHA A-B PLUS 0803701 - plastic anti-bacterial trolley

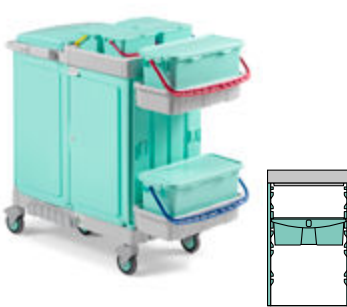

REF.	SIZE (cm)
MZ0803701Z900	120x66x112

ALPHA A-B PLUS 0803705 - antibacterial plastic trolley with Click Safe system

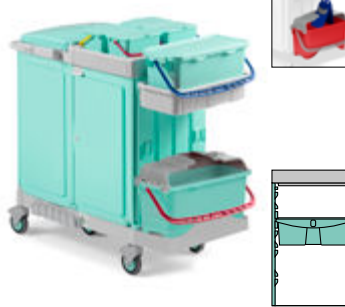

REF.	SIZE (cm)
MZ0803705Z901	120x66x112

Click Safe system requires the use of the corresponding Click Safe folding mop holder (See the catalog under the line Soaking and Floor Washing Systems - system with pockets)

ALPHA A-B PLUS 3803702 - plastic anti-bacterial trolley



REF.	SIZE (cm)
MZ3803702Z900	120x66x110

A-B PLUS anti-bacterial system



A-B PLUS

A-B PLUS related products

CLICK SAFE - plastic foldable mop holder with Lock System fitting



REF.	NOTES	SIZE (cm) ↓ ↓ ↓
0000TP0312U		40x11

UNIKO - foldable anti-bacterial plastic mop holder with mop fixing clip and Lock System



REF.	NOTES	SIZE (cm) ↓ ↓ ↓
0000TD0320FZ		40x11

Mop **A-B PLUS** anti-bacterial ultra-microfiber pocket mop



REF.	NOTES	SIZE (cm) ↓ ↓ ↓
0000PN04012EZ		40x13

Ideal for hospital indoor floors with a medium degree of dirt

Aluminium mop holder and anti-bacterial plastic components with strips for strap tape system and Lock System fitting



REF.	NOTES	SIZE (cm) ↓ ↓ ↓
0000TA0340FZ		40

A-B PLUS anti-bacterial ultra-microfiber mop with strap tape system and colour-coded tag



REF.	NOTES	SIZE (cm) ↓ ↓ ↓
0000PN03012EZ		40

Ideal for hospital indoor floors with a medium degree of dirt

MOVE - plastic handle holder for ø 26 mm handles



REF.	NOTES
0000SM00147FZ	

Anodized aluminium telescopic handle with anti-bacterial components - 2 pcs

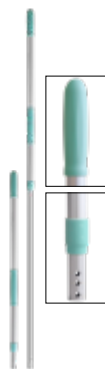

REF.	NOTES	SIZE (cm) ↓ ↓ ↓
0000AM3040FZ		182

Extendible from 100 to 182 cm - External tube ø 26 mm, internal tube ø 23 mm

MULTI-T A-B PLUS - anti-bacterial ultra-microfiber multipurpose cloth



REF.	NOTES	NET WEIGHT (kg)	SIZE (cm) ↓ ↓ ↓
TCH101410		0,056	40x40
TCH101420		0,056	40x40
TCH101430		0,056	40x40
TCH101440		0,056	40x40
TCH101419	pck.: 40 polybags with 5 pcs	11,2	40x40
TCH101429	pck.: 40 polybags with 5 pcs	11,2	40x40
TCH101439	pck.: 40 polybags with 5 pcs	11,2	40x40
TCH101449	pck.: 40 polybags with 5 pcs	11,2	40x40

With anti-bacterial treatment, it removes up to 99,98% of bacteria and fungi - Cloth for any surface and for very dirty environments - Resistant, it removes and keeps dirt - Weight 310 gr/mq

A-B PLUS

A-B PLUS Components

Anti-bacterial long plastic base for Alpha trolley



REF.	NOTES	SIZE (cm) ↓ ↓ ↓
P166031EZ	with five ø 125 mm rubber wheels	91x52

Anti-bacterial supporting plastic plate for bases Alpha trolley



REF.	NOTES	SIZE (cm) ↓ ↓ ↓
P165000EZ		48x22x15

Anti-bacterial vertical frame, 1 side with 6 slides + 1 side for T-plugs, complete with screws and plugs

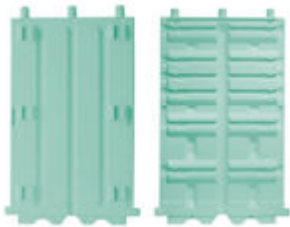

REF.	NOTES
P2039903FZ	

Anti-bacterial vertical frame, 2 sides with slides, complete with screws and plugs

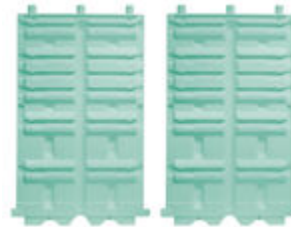

REF.	NOTES
P2039904FZ	

Anti-bacterial set of T-shaped closing plugs for vertical frames (6 pcs)



REF.	NOTES
0000SM00165Z	

Anti-bacterial fixed side wall with fixing pins



REF.	NOTES
P3909953FZ	

Plastic antibacterial door with fixing pins



REF.	NOTES
P3909954FZ	

Antibacterial plastic door for 150l waste bag holder, with fastening pins



REF.	NOTES
P3909952FZ	

Anti-bacterial central plastic basket (female-female version) with plugs



REF.	NOTES
020P2199906EZ	internal sizes 31x48x8 cm

Anti-bacterial central plastic basket (male-female version) complete with screws and plugs



REF.	NOTES
020P2199907EZ	internal sizes 31x48x8 cm

A-B PLUS anti-bacterial system



A-B PLUS

Anti-bacterial central plastic frame with cover with locking key and 2 shock absorbing pistons for versions with buckets 4 L

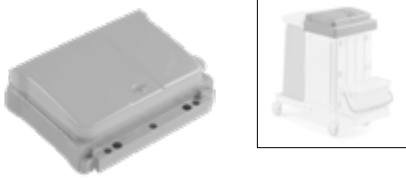

REF.	NOTES
P3199903EZ	

Anti-bacterial side plastic basket



REF.	NOTES
P1191100EZ	internal sizes 22x49x11,5 cm

Anti-bacterial closing profile for central basket/bag holder complete with screws and plugs



REF.	NOTES
P2909920EZ	

Anti-bacterial closing profile with push-grip for central basket complete with screws and plugs

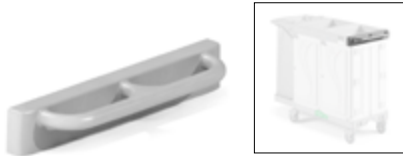

REF.	NOTES
P2909921EZ	

2x60 antibacterial plastic waste bag holder, male fitting, with 2 handle clips, 2 fixed dustpan hooks, screws and plugs

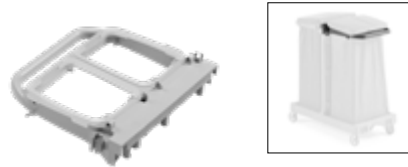

REF.	NOTES
P8161114EZ	

Anti-bacterial bag holder 150 lt (male version) complete with screws and plugs

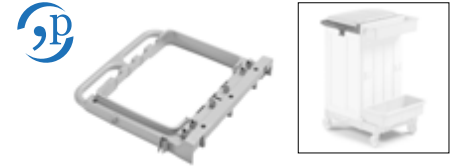

REF.	NOTES
P8169905EZ	

Divider for plastic anti-bacterial bag holder 150 lt



REF.	NOTES
P2909912EZ	

Anti-bacterial plastic sliding drawer without locking key



REF.	NOTES	CAPACITY (L)
P1229906FZ	internal dimensions 40,5x34x16 cm	22
P1229907FZ	internal dimensions 40x34x33,5 cm	40

Anti-bacterial plastic slider drawer with locking key



REF.	NOTES	CAPACITY (L)
P2229906FZ	internal dimensions 40,5x34x16 cm	22
P2229907FZ	internal dimensions 40x34x33,5 cm	40

Anti-bacterial plastic lift for buckets, with holes for bottles, fitting drawers 22 and 40 lt



REF.	NOTES
P1909937EZ	

Anti-bacterial green plastic bucket 4 lt with coloured plastic handle



REF.	NOTES	SIZE (cm)
		↓ ↓ ↓
0000SE0104FAZ		17x25,5x19,5
0000SE0104FBZ		17x25,5x19,5
0000SE0104FCZ		17x25,5x19,5
0000SE0104FFZ		17x25,5x19,5

Anti-bacterial green plastic bucket 4 lt with coloured upper plastic handle



REF.	NOTES	SIZE (cm)
		↓ ↓ ↓
0000SE0204FAZ		16,5x21x22,5
0000SE0204FBZ		16,5x21x22,5
0000SE0204FCZ		16,5x21x22,5
0000SE0204FFZ		16,5x21x22,5

A-B PLUS

A-B PLUS

TOP-DOWN® - green antibacterial plastic bucket 20 lt with coloured plastic handle and hermetic cover



REF.	NOTES	SIZE (cm) ↓ ↓ ↓
0000SE1322FAZ	■	24x55x27
0000SE1322FBZ	■	24x55x27

Green antibacterial plastic bucket 20 lt with coloured plastic handle



REF.	NOTES	SIZE (cm) ↓ ↓ ↓
0000SE1222FBZ		24x55x27

Plastic cover for Click Safe system

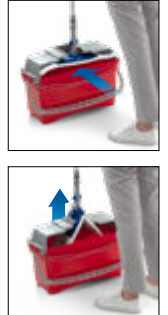

REF.	NOTES	SIZE (cm) ↓ ↓ ↓
P190360U		55x23x12

Anti-bacterial handle holder for Alpha bag holder and closing profile



REF.	NOTES
60072EZ	

Anti-bacterial hook



REF.	NOTES
60082EZ	

Antibacterial plastic mop holder fitting the base of the Alpha trolley



REF.	NOTES
P1909948EZ	

Accessories for A-B PLUS

JOBBY - plastic bin with aluminium handle and cover



REF.	NOTES	SIZE (cm) ↓ ↓ ↓
000010105U	■	29x28x87,5

With serrated edge for an easy removal of the dirt from the broom

SPARK - cloth holder with rubber blades



REF.	NOTES	SIZE (cm) ↓ ↓ ↓
002072001U		60x11

Autoclavable

4 lt anti-bacterial plastic bucket with handle and hermetic cover with central slot for cloth extraction



REF.	NOTES	SIZE (cm) ↓ ↓ ↓
0000SE3104FAZ	■	17x25,5x25
0000SE3104FBZ	■	17x25,5x25
0000SE3104FCZ	■	17x25,5x25
0000SE3104FFZ	■	17x25,5x25

To be used with manual disposable TNT MONO-ROLL cloth art. 00PU0203000



A-B PLUS

Anti-bacterial pedal set for Alpha trolleys with long base, closed bag holder 150 L and wheels \varnothing 125 mm



REF.	NOTES
P2909918FZ	

Only for bases with 4 wheels

Anti-bacterial plastic cover for bag holder 120 L



REF.	NOTES
P291918FZ	

Please, require also no. 2 shock absorbing pistons art. P190908U for a perfect soft closing

Anti-bacterial plastic cover for bag holder 150 lt



REF.	NOTES
P2909946FZ	

Please, require also no. 2 shock absorbing pistons art. P190908U for a perfect soft closing

Shock absorbing piston for a soft closing of the cover



REF.	NOTES
P190908U	

Green anti-bacterial plastic cover with hinges



REF.	NOTES
0000CP1204FZ	for bucket 4 L art. 0000SE0104

Anti-bacterial plastic divider for Top-Down® bucket 20 lt



REF.	NOTES
P190350FZ	

Anti-bacterial pierced plastic sieve for Top-Down® bucket 20 lt

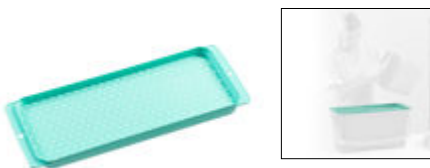

REF.	NOTES
P1190042FZ	

Ideal for a uniform distribution of the cleaning solution
- For a quick pre-soaking (max 15 minutes)



Waste collection



Bins for separate
waste collection

Sanitary bins

Waste trolleys

Paper holders



BINS FOR SEPARATE WASTE COLLECTION

SANITARY BINS

WASTE TROLLEYS

PAPER HOLDERS

Atlix: the waste collection that makes a difference

Atlix is a range of bins characterized by a modern, stylish and functional design, specifically conceived to make waste collection easier and more convenient.

Atlix Line



AtlixPress

Compliant with **H.A.C.C.P.** rules, avoids contact with hands thanks to the pedal. The cover can be **graphically customized** to turn the bin into a means of communication or to fit the environment.



50 lt



AtlixFlip

Equipped with an asymmetrical swing cover with **anti-shock opening** and **lock for easy operation**, color-coded available.

Available also in the **ATLAXFLIP ECO** version, with a high percentage of recycled plastic.



50 lt

25 lt



AtlixFit

Range of bins with shaped covers to **make sorting waste collection intuitive**.

The inserts are available in **color-code** to customize the collection of different types of waste, making handling easier.



25
50 lt



BINS FOR SEPARATE WASTE COLLECTION

SANITARY BINS

WASTE TROLLEYS

PAPER HOLDERS

Atlax bins

ATLAXPRESS - white plastic bin with cover and pedal



REF.	CAPACITY (L)	PCK	SIZE (cm) ↓ ↓ ↓
0000C08050D	50	3	37x40,5x57
0001C08050D	50	1	37x40,5x57

Advised bags size: 65x65 cm

Plastic bag stretcher for AtlaxPress bin



REF.	NOTES
P190077D	

Shock absorbing piston for a soft closing of the cover



REF.	NOTES
P190802U	

ATLAXFLIP - white plastic bin with coloured swing cover



REF.	CAPACITY (L)	PCK	SIZE (cm) ↓ ↓ ↓
0000C07025D	25	4	26,5x33x52
0020C07025DA	25	4	26,5x33x52
0020C07025DB	25	4	26,5x33x52
0020C07025DC	25	4	26,5x33x52
0020C07025DF	25	4	26,5x33x52
0001C07025D	25	1	26,5x33x52
0120C07025DA	25	1	26,5x33x52
0120C07025DB	25	1	26,5x33x52
0120C07025DC	25	1	26,5x33x52
0120C07025DF	25	1	26,5x33x52
0000C07050D	50	4	31,5x39x67
0020C07050DA	50	4	31,5x39x67
0020C07050DB	50	4	31,5x39x67
0020C07050DC	50	4	31,5x39x67
0020C07050DF	50	4	31,5x39x67
0001C07050D	50	1	31,5x39x67
0120C07050DA	50	1	31,5x39x67
0120C07050DB	50	1	31,5x39x67
0120C07050DC	50	1	31,5x39x67
0120C07050DF	50	1	31,5x39x67

Advised bag size: 50x60 cm for 25 lt and 60x65 cm for 50 lt

ATLAXFLIP ECO - gray plastic bin with swing lid



REF.	CAPACITY (L)	PCK	SIZE (cm) ↓ ↓ ↓
0000C07050U1	50	4	31,5x39x67
0001C07050U1	50	1	31,5x39x67

Advised bags size: 65x65 cm



BINS FOR SEPARATE WASTE COLLECTION

SANITARY BINS

WASTE TROLLEYS

PAPER HOLDERS

ATLAXFIT - white plastic bin with shaped lid for separate waste collection



REF.	NOTES	CAPACITY (L)	PCK	SIZE (cm) ↓ ↓ ↓
0000CO7125DL1	insert for paper	25	3	26,5x33x46
0000CO7125DC1	insert for paper	25	3	26,5x33x46
0000CO7225DB1	insert for glass/plastic/metal	25	3	26,5x33x46
0000CO7225DC1	insert for glass/plastic/metal	25	3	26,5x33x46
0000CO7225DF3	insert for glass/plastic/metal	25	3	26,5x33x46
0000CO7325DU	insert for mixed waste	25	3	26,5x33x46
0000CO7425DG1	insert for organic waste	25	3	26,5x33x46
0000CO7425DU	insert for organic waste	25	3	26,5x33x46
0001CO7125DL1	insert for paper	25	1	26,5x33x46
0001CO7125DC1	insert for paper	25	1	26,5x33x46
0001CO7225DB1	insert for glass/plastic/metal	25	1	26,5x33x46
0001CO7225DC1	insert for glass/plastic/metal	25	1	26,5x33x46
0001CO7225DF3	insert for glass/plastic/metal	25	1	26,5x33x46
0001CO7325DU	insert for mixed waste	25	1	26,5x33x46
0001CO7425DG1	insert for organic waste	25	1	26,5x33x46
0001CO7425DU	insert for organic waste	25	1	26,5x33x46
0000CO7150DL1	insert for paper	50	3	31,5x39x61
0000CO7150DC1	insert for paper	50	3	31,5x39x61
0000CO7250DB1	insert for glass/plastic/metal	50	3	31,5x39x61
0000CO7250DC1	insert for glass/plastic/metal	50	3	31,5x39x61
0000CO7250DF3	insert for glass/plastic/metal	50	3	31,5x39x61
0000CO7350DU	insert for mixed waste	50	3	31,5x39x61
0000CO7450DG1	insert for organic waste	50	3	31,5x39x61
0000CO7450DU	insert for organic waste	50	3	31,5x39x61
0001CO7150DL1	insert for paper	50	1	31,5x39x61
0001CO7150DC1	insert for paper	50	1	31,5x39x61
0001CO7250DB1	insert for glass/plastic/metal	50	1	31,5x39x61
0001CO7250DC1	insert for glass/plastic/metal	50	1	31,5x39x61
0001CO7250DF3	insert for glass/plastic/metal	50	1	31,5x39x61
0001CO7350DU	insert for mixed waste	50	1	31,5x39x61
0001CO7450DG1	insert for organic waste	50	1	31,5x39x61
0001CO7450DU	insert for organic waste	50	1	31,5x39x61

Advised bag size: 50x60 cm for 25 lt and 60x65 cm for 50 lt

White plastic bin without cover



REF.	NOTES	CAPACITY (L)	SIZE (cm) ↓ ↓ ↓
P190081D		25	25,5x32x40
P190071D		50	30x38x50
P190071U1		50	30x38x50

Complete cover for AtlaxFlip bin



REF.	NOTES	
P190082D	for AtlaxFlip 50 lt	
0020P190082DA	for AtlaxFlip 50 lt	
0020P190082DB	for AtlaxFlip 50 lt	
0020P190082DC	for AtlaxFlip 50 lt	
0020P190082DF	for AtlaxFlip 50 lt	
P190072D	for AtlaxFlip 50 lt	
P190072U1	for AtlaxFlip 50 lt	
0020P190072DA	for AtlaxFlip 50 lt	
0020P190072DB	for AtlaxFlip 50 lt	
0020P190072DC	for AtlaxFlip 50 lt	
0020P190072DF	for AtlaxFlip 50 lt	



BINS FOR SEPARATE WASTE COLLECTION

SANITARY BINS

WASTE TROLLEYS

PAPER HOLDERS

Complete cover for AtlatxFit bin



Plastic bag stretcher for AtlatxFlip and AtlatxFit bin



REF.	NOTES	
P190083DL1	insert for paper, for AtlatxFit 25 lt	
P190083DC1	insert for paper, for AtlatxFit 25 lt	
P190084DB1	insert for glass/plastic/metal, for AtlatxFit 25 lt	
P190084DC1	insert for glass/plastic/metal, for AtlatxFit 25 lt	
P190084DF3	insert for glass/plastic/metal, for AtlatxFit 25 lt	
P190085DU	insert for mixed waste, for AtlatxFit 25 lt	
P290084DG1	insert for organic waste, for AtlatxFit 25 lt	
P290084DU	insert for organic waste, for AtlatxFit 25 lt	
P190073DL1	insert for paper, for AtlatxFit 50 lt	
P190073DC1	insert for paper, for AtlatxFit 50 lt	
P190074DB1	insert for glass/plastic/metal, for AtlatxFit 50 lt	
P190074DC1	insert for glass/plastic/metal, for AtlatxFit 50 lt	
P190074DF3	insert for glass/plastic/metal, for AtlatxFit 50 lt	
P190075DU	insert for mixed waste, for AtlatxFit 50 lt	
P290074DG1	insert for organic waste, for AtlatxFit 50 lt	
P290074DU	insert for organic waste, for AtlatxFit 50 lt	

REF.	NOTES
0000SM00287	for bin 25 lt
P190076D	for bin 50 lt

Adhesive label with drawing for separate waste collection for AtlatxFit bin cover



REF.	NOTES
801400	

Rilsan coated wall-fixing support for AtlatxFlip and AtlatxFit bins

NEW



REF.	NOTES
R2180406	



BINS FOR SEPARATE WASTE COLLECTION

SANITARY BINS

WASTE TROLLEYS

PAPER HOLDERS

Patty bins

PATTY - plastic white bin with coloured swing cover



REF.	NOTES	CAPACITY (L)	SIZE (cm) ↓ ↓ ↓
8162	with white swing cover	12	20x25x40
8162A	with blue swing cover	12	20x25x40
8162B	with red swing cover	12	20x25x40
8162C	with yellow swing cover	12	20x25x40
8162E	with grey swing cover	12	20x25x40
8162F	with green swing cover	12	20x25x40
8162G	with brown swing cover	12	20x25x40

Advised bag size: 50x60 cm

Brown available while stocks last

White plastic bin without cover



REF.	NOTES	CAPACITY (L)	SIZE (cm) ↓ ↓ ↓
8162/1		12	19x24,5x30

White cover with coloured swing for Patty bin



REF.	NOTES
60193	for Patty 12 lt
60193A	for Patty 12 lt
60193B	for Patty 12 lt
60193C	for Patty 12 lt
60193E	for Patty 12 lt
60193F	for Patty 12 lt
60193G	for Patty 12 lt

Brown available while stocks last



BINS FOR SEPARATE WASTE COLLECTION

SANITARY BINS

WASTE TROLLEYS

PAPER HOLDERS

Patty bins with pedal

PATTY - plastic white bin with cover and pedal



REF.	NOTES	CAPACITY (L)	SIZE (cm) ↓ ↓ ↓
8169/2	with white cover	25	28x34x47
8169/2A	with blue cover	25	28x34x47
8169/2B	with red cover	25	28x34x47
8169/2C	with yellow cover	25	28x34x47
8169/2F	with green cover	25	28x34x47

Advised bag size: 50x60 cm

Plastic bin with handle for Patty bin



REF.	NOTES	CAPACITY (L)	SIZE (cm) ↓ ↓ ↓
8168/1A	for Patty cod. 8169/2	10	13,5x21x36
8168/1B	for Patty cod. 8169/2	10	1,53x21x36
8168/1U		10	13,5x21x36



BINS FOR SEPARATE WASTE COLLECTION

SANITARY BINS

WASTE TROLLEYS

PAPER HOLDERS

Sirius waste collection bins:

- **Environmentally friendly:** partly made of plastic components certified **Plastic Second Life** according to the **Green Public Procurements** environmental policies
- **Versatile:** available in the 60L, 30L, 2x30L, 2x15L, 30 + 2x15L and 15 + 2x8L versions for a better separate waste collection
- **Hygienic:** thanks to their round-shaped line
- **Ergonomic:** foot pedal opening cover; built-in pedal to avoid bin upsetting and reduce the overall dimensions of the bin
- **In compliance with HACCP rules:** it is the ideal bin for kitchens, restaurants, canteens and all the environments associated with food processing activities



Available in **white with colored cover** and in **white single color** version



Sirius bins

SIRIUS - plastic white bin with pedal, bag stretcher and coloured cover

SIRIUS - plastic white bin with divider, pedal, bag stretcher and coloured cover



REF.	NOTES	CAPACITY (L)	SIZE (cm)
			↓ ↓ ↓
0000C03030D	with white cover	30	37x51x47
0000C03031D	with blue cover	30	37x51x47
0000C03032D	with red cover	30	37x51x47
0000C03033D	with yellow cover	30	37x51x47
0000C03034D	with green cover	30	37x51x47
0000C03036D	with brown cover	30	37x51x47
0000C03060D	with white cover	60	37x51x67
0000C03061D	with blue cover	60	37x51x67
0000C03062D	with red cover	60	37x51x67
0000C03063D	with yellow cover	60	37x51x67
0000C03064D	with green cover	60	37x51x67
0000C03066D	with brown cover	60	37x51x67

Advised bag size: 70x40 cm for 30 lt and 70x110 cm for 60 lt

REF.	NOTES	CAPACITY (L)	SIZE (cm)
			↓ ↓ ↓
0000C03130D	with white cover	2x15 lt	37x51x47
0000C03131D	with blue cover	2x15 lt	37x51x47
0000C03132D	with red cover	2x15 lt	37x51x47
0000C03133D	with yellow cover	2x15 lt	37x51x47
0000C03134D	with green cover	2x15 lt	37x51x47
0000C03136D	with brown cover	2x15 lt	37x51x47
0000C03160D	with white cover	2x30 L	37x51x67
0000C03161D	with blue cover	2x30 L	37x51x67
0000C03162D	with red cover	2x30 L	37x51x67
0000C03163D	with yellow cover	2x30 L	37x51x67
0000C03164D	with green cover	2x30 L	37x51x67
0000C03166D	with brown cover	2x30 L	37x51x67

Advised bag dimensions: 50x60 cm for 15L and 50x70 cm for 30L



BINS FOR SEPARATE WASTE COLLECTION

SANITARY BINS

WASTE TROLLEYS

PAPER HOLDERS

SIRIUS - plastic white bin with triple divider, pedal, bag stretcher and coloured cover

Plastic cover for Sirius bins 30 lt and 60 lt with bag stretcher, cage for deodorant pills and pins



REF.	NOTES	CAPACITY (L)	SIZE (cm)
0000C03230D	with white cover	15 L + 2x8 L	37x51x47
0000C03231D	with blue cover	15 L + 2x8 L	37x51x47
0000C03232D	with red cover	15 L + 2x8 L	37x51x47
0000C03233D	with yellow cover	15 L + 2x8 L	37x51x47
0000C03234D	with green cover	15 L + 2x8 L	37x51x47
0000C03236D	with brown cover	15 L + 2x8 L	37x51x47
0000C03260D	with white cover	30 L + 2x15 L	37x51x67
0000C03261D	with blue cover	30 L + 2x15 L	37x51x67
0000C03262D	with red cover	30 L + 2x15 L	37x51x67
0000C03263D	with yellow cover	30 L + 2x15 L	37x51x67
0000C03264D	with green cover	30 L + 2x15 L	37x51x67
0000C03266D	with brown cover	30 L + 2x15 L	37x51x67

REF.	NOTES
P290934A	Blue
P290934B	Red
P290934C	Yellow
P290934D	White
P290934F	Green
P290934G	Brown

Advised bag dimensions: 50x60 cm for 15L and 8L and 50x70 cm for 30L

Plastic divider for Sirius bins 30 lt and 60 lt

Sticky label 11x11,5 cm with image for separate waste collection

Sticky label 11x11,5 cm with image and writing for separate waste collection



REF.	NOTES
P190926D	
P190937D	for 3-hole configurations

REF.	NOTES
701421	with image "metal"
701422	with image "paper"
701424	with design "organic waste"
701425	with image "plastic"
701426	with image "glass"
701428	with design "mixed waste"

REF.	NOTES
701431	with image and writing "metalli"
701432	with image and writing "carta"
701440	with design and writing "organic waste"
701435	with image and writing "plastica"
701436	with image and writing "vetro"
701439	with design and writing "mixed waste"



BINS FOR SEPARATE WASTE COLLECTION

SANITARY BINS

WASTE TROLLEYS

PAPER HOLDERS

Sally bins

SALLY - plastic bin with cover and pedal



REF.	NOTES	CAPACITY (L)	SIZE (cm) ↓ ↓ ↓
0000CO1017D		17	42x20x46
0000CO1023D		23	42x20x59

Advised bag size: 50x60 cm for 17 lt and 55x65 cm for 23 lt

Rilsan coated wall-fixing support for Sally and Desy bins



REF.	NOTES
R2180400	only for Sally-Desy 17 L

Pick-Up bins

PICK-UP - plastic bin 45 L without wheels, complete with cover and screen printed plastic plate



REF.	NOTES	SIZE (cm) ↓ ↓ ↓
3667A	with image "paper"	51x31,5x30
3667B	with image "metal"	51x31,5x30
3667C	with image "plastic"	51x31,5x30
3667E	with image "non-recyclable waste"	51x31,5x30
3667F	with image "glass"	51x31,5x30
3667G	with image "organic waste"	51x31,5x30

PICK-UP - plastic bin 45 L without wheels, complete with cover and white plastic plate



Food contact



REF.	NOTES	SIZE (cm) ↓ ↓ ↓
3667T		51x31,5x30

Product suitable for contact with food in accordance with European regulations (EC Regulation 1935/2004 and EU Regulation No. 10/2011) - Compliance Declaration attached to the technical sheet

Plastic bin 45 lt without cover for Pick-Up bin



REF.	NOTES
3645A	
3645B	
3645C	
3645E	
3645F	
3645G	
3645T	

Plastic cover for Pick-Up bin



REF.	NOTES
3648A	with image "paper"
3648B	with image "metal"
3648C	with image "plastic"
3648E	with image "non-recyclable waste"
3648F	with image "glass"
3648G	with image "organic waste"
3648T	without image



BINS FOR SEPARATE WASTE COLLECTION

SANITARY BINS

WASTE TROLLEYS

PAPER HOLDERS

Screen printed plastic plate with image for separate waste collection



REF.	NOTES
601421	with image "metal"
601422	with image "paper"
601424	with image "organic waste"
601425	with image "plastic"
601426	with image "glass"
601428	with image "non-recyclable waste"

Wheel ø 35 mm



REF.	NOTES
2793	for Prisma, Twin, Top-Down®, Pick-Up, Trend and art. 0000SE1428

Wheel ø 50 mm



REF.	NOTES
7949	For King, Spider, Rocket Wheels, Duo Pro System, Prisma, Twin, Top-Down®, Pick-Up, Trend and code 0000SE1428

Domino bins

DOMINO - plastic bin 25 L with 2 small oval plastic containers and plates



REF.	NOTES	SIZE (cm)
10300		46x24,5x36 ↓ ↓ ↓

DOMINO - plastic bin 25 L with 1 small oval plastic container and 1 rectangular plastic container



REF.	NOTES	SIZE (cm)
10305		46x24,5x36 ↓ ↓ ↓

Plastic bin 25 L for Domino bin



REF.	NOTES	SIZE (cm)
10200		46x24,5x36 ↓ ↓ ↓

Container with cover for Domino



REF.	NOTES	CAPACITY (L)
10201	oval	3
10202	rectangular	2

Set of coloured plates for Domino bin



REF.	NOTES
10204	



BINS FOR SEPARATE WASTE COLLECTION

SANITARY BINS

WASTE TROLLEYS

PAPER HOLDERS

Bins with metal handle

Plastic bin 12 L with metal handle and cover with locking key



REF.	NOTES	SIZE (cm) ↓ ↓ ↓
0000C02012U		21x26x36

Thanks to its locking key, it is possible to transport chemical and/or toxic products inside the bin safely

Plastic bin 12 L with cover and metal handle



REF.	NOTES	CAPACITY (L)	SIZE (cm) ↓ ↓ ↓
8145G		12	22x27x30,5

Steel bins

POIS - stainless steel dustbin with pedal opening system



REF.	NOTES	CAPACITY (L)
00005836	ø 17 x 26,5 cm	3
00005835	ø 20,5 x 29,5 cm	5
00005830	ø 25 x 40 cm	12

Oyster bins

OYSTER - wall mounted plastic bin 50 L with pedal and cover



REF.	NOTES	CAPACITY (L)	SIZE (cm) ↓ ↓ ↓
0000C05050D	with all the components in white colour		50 39x53,5x81
0000C05050U	with all the components in grey colour		50 39x53,5x81
0000C05050DUD	white, with grey pedal		50 39x53,5x81
0000C05050DUA	white, with grey pedal and blue cover		50 39x53,5x81
0000C05050DUB	white, with grey pedal and red cover		50 39x53,5x81
0000C05050DUC	white, with grey pedal and yellow cover		50 39x53,5x81
0000C05050DUF	white, with grey pedal and green cover		50 39x53,5x81
0000C05050DUU	white, with grey pedal and grey cover		50 39x53,5x81

Advised bag size: 70x110 cm

Full gray bin available while stocks last



BINS FOR SEPARATE WASTE COLLECTION

SANITARY BINS

WASTE TROLLEYS

PAPER HOLDERS

OYSTER - wall mounted plastic bin 50 L without pedal and without cover



Plastic cover for Oyster bin



REF.	NOTES
0000C05150D	<input type="checkbox"/>
0000C05150U	<input type="checkbox"/>
Advised bag size: 70x110 cm	
Grey color available while supplies last	

REF.	NOTES
P190060A	<input type="checkbox"/>
P190060B	<input type="checkbox"/>
P190060C	<input type="checkbox"/>
P190060D	<input type="checkbox"/>
P190060F	<input type="checkbox"/>
P190060U	<input type="checkbox"/>

Plastic bag stretcher for Oyster bin



Plastic key for Oyster bin



Shock absorbing piston for a soft closing of the cover



REF.	NOTES
SLP01500001D	<input type="checkbox"/>
SLP01500001U	<input type="checkbox"/>
Grey color available while supplies last	

REF.	NOTES
SLP01500009H	

REF.	NOTES
P190908U	

Plastic pedal for Oyster bin



Plastic rod for wall mounting Oyster bin



Plastic pedal rod for Oyster bin



REF.	NOTES
SLP01500004D	<input type="checkbox"/>
SLP01500004U	<input type="checkbox"/>

REF.	NOTES
P190061H	

REF.	NOTES
SLP01500007H	

Painted display stand support complete with screws for Oyster bin



Double-sided tape set for Oyster wall mounting

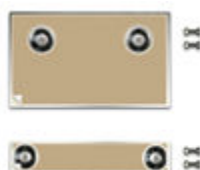

REF.	NOTES
V190062	

REF.	NOTES
0000SM00600	



BINS FOR SEPARATE WASTE COLLECTION

SANITARY BINS

WASTE TROLLEYS

PAPER HOLDERS

Handy bins

HANDY - bin 70 L with drain plug, wheels, bag stretcher, grip and cover



REF.	NOTES	SIZE (cm) ↓ ↓ ↓
0000C06170E		51,5x56x86

Advised bag size: 75x110 cm

HANDY - bin 70 L with drain plug, wheels and bag stretcher



REF.	NOTES	SIZE (cm) ↓ ↓ ↓
P391070E	with push-bar	51,5x56x86
P291070E	without push-bar	37x56x71

Advised bag size: 75x110 cm

Cover set complete with rubber lace, cage for deodorant pills and screws



REF.	NOTES
P290068E	

Assembling kit to fix Handy bin to Alpha vertical frame



REF.	NOTES
0000SM00610	



BINS FOR SEPARATE WASTE COLLECTION

SANITARY BINS

WASTE TROLLEYS

PAPER HOLDERS

The **Polaris Delux** bin 90 L is handy and can be placed everywhere; it is made **in compliance with the HACCP rules**: therefore, it is the ideal bin for kitchens, restaurants, canteens and all the environments associated with food processing activities. It is completely made of polypropylene, strong and round-shaped for an easy cleaning.



It can be equipped with shock absorbing pistons "Hush System" for a soft closing of the cover and with several accessories, such as a multipurpose plastic basket, a paper-roll holder and several different hooks to carry small cleaning tools.

It is equipped with an ergonomic push-bar and plastic wheels \varnothing 125 mm to handle the bin better and easier.

The cover has a 90° opening that helps the operator while emptying the bin.

The door has a 250° opening that allows to take out and empty the bag in a practical way reducing the operator's efforts.



Complete with shock absorbing pistons, two plastic hooks to fix the bag and with a cage for deodorant or disinfectant pills.

Polaris Delux bins

POLARIS DELUX - beige plastic bin 90 L with front door, pedal, push-bar, wheels \varnothing 125 mm and coloured cover, equipped with shock-absorbing pistons

POLARIS DELUX - beige plastic bin 90 L with bag holder 2x45 L, front door, pedal, push-bar, wheels \varnothing 125 mm and coloured cover, equipped with shock-absorbing pistons



REF.	NOTES	SIZE (cm)
0000C03090I	with beige cover	49x52x93
0000C03091I	with blue cover	49x52x93
0000C03092I	with red cover	49x52x93
0000C03093I	with yellow cover	49x52x93
0000C03094I	with green cover	49x52x93

REF.	NOTES	SIZE (cm)
0000C03190I	with beige cover	49x52x93
0000C03191I	with blue cover	49x52x93
0000C03192I	with red cover	49x52x93
0000C03193I	with yellow cover	49x52x93
0000C03194I	with green cover	49x52x93

With surcharge available in single package - To order it single packed, just add 0001 before the letters in the standard reference. Es: 0001C03090I - Advised bag size: 80x110 cm

With surcharge available in single package - To order it single packed, just add 0001 before the letters in the standard reference. Es: 0001C03190I - Advised bags size: 70x110 cm



BINS FOR SEPARATE WASTE COLLECTION

SANITARY BINS

WASTE TROLLEYS

PAPER HOLDERS

Polaris bins

POLARIS - beige plastic bin 90 L with pedal, push-bar, wheels Ø 100 mm and coloured cover



REF.	NOTES	SIZE (cm) ↓ ↓ ↓
0000C02090I	with beige cover	49x52x93
0000C02091I	with blue cover	49x52x93
0000C02092I	with red cover	49x52x93
0000C02093I	with yellow cover	49x52x93
0000C02094I	with green cover	49x52x93

With surcharge available in single package - To order it single packed, just add 0001 before the letters in the standard reference. Ex: 0001C02090I - Advised bag size: 80x110 cm

POLARIS - beige plastic bin 90 L with bag holder 2x45 L, pedal, push-bar, wheels Ø 100 mm and coloured cover



REF.	NOTES	SIZE (cm) ↓ ↓ ↓
0000C02190I	with beige cover	49x52x93
0000C02191I	with blue cover	49x52x93
0000C02192I	with red cover	49x52x93
0000C02193I	with yellow cover	49x52x93
0000C02194I	with green cover	49x52x93

With surcharge available in single package - To order it single packed, just add 0001 before the letters in the standard reference. Es: 0001C02190I - Advised bags size 70x110 cm

Components for Polaris and Polaris Delux

Beige Polaris plastic bin 90 lt without cover, with pedal, push-grip and wheels Ø 100 mm



REF.	NOTES
P190915I	

Advised bag size: 80x110 cm

Plastic cover for Polaris and Polaris Delux



REF.	NOTES
P190914A	for 90 lt Polaris
P190914B	for 90 lt Polaris
P190914C	for 90 lt Polaris
P190914F	for 90 lt Polaris
P190914I	for 90 lt Polaris
P290914A	for 90 lt Polaris Delux
P290914B	for 90 lt Polaris Delux
P290914C	for 90 lt Polaris Delux
P290914F	for 90 lt Polaris Delux
P290914I	for 90 lt Polaris Delux
P390914A	for Polaris and 2x45 lt Polaris Delux
P390914B	for Polaris and 2x45 lt Polaris Delux
P390914C	for Polaris and 2x45 lt Polaris Delux
P390914F	for Polaris and 2x45 lt Polaris Delux
P390914I	for Polaris and 2x45 lt Polaris Delux

Please, require also no. 2 shock absorbing pistons art. P190908U for a perfect soft closing



BINS FOR SEPARATE WASTE COLLECTION

SANITARY BINS

WASTE TROLLEYS

PAPER HOLDERS

Accessories for Polaris and Polaris Delux

Shock absorbing piston for a soft closing of the cover



REF.	NOTES
P190908U	

Sticky label 11x11,5 cm with image for separate waste collection



REF.	NOTES
701421	with image "metal"
701422	with image "paper"
701424	with design "organic waste"
701425	with image "plastic"
701426	with image "glass"
701428	with design "mixed waste"

Sticky label 11x11,5 cm with image and writing for separate waste collection



REF.	NOTES
701431	with image and writing "metalli"
701432	with image and writing "carta"
701440	with design and writing "organic waste"
701435	with image and writing "plastica"
701436	with image and writing "vetro"
701439	with design and writing "mixed waste"

Plastic handle holder for Polaris and Polaris Delux bins



REF.	NOTES
0000SM0131I	

Plastic hook for Polaris and Polaris Delux bins



REF.	NOTES
0000SM0132I	

FLIP - handle holder with rubber roll for Polaris and Polaris Delux bins



REF.	NOTES
0000SM00111	

Plastic side basket set for Polaris and Polaris Delux bins



REF.	NOTES
0000SM0133I	

Set of paper holder with cover and 3 hooks for Polaris and Polaris Delux bins



REF.	NOTES
P225006I	



BINS FOR SEPARATE WASTE COLLECTION

SANITARY BINS

WASTE TROLLEYS

PAPER HOLDERS

Plastic containers 120 and 240 liters

Polyethylene bin with cover, bag stretcher and axial wheels ø 200 mm



REF.	NOTES	CAPACITY (L)	SIZE (cm) ↓ ↓ ↓
0000C01120D	<input type="checkbox"/>	120	55x48x93
0000C01120F	<input checked="" type="checkbox"/>	120	55x48x93
0000C01240D	<input type="checkbox"/>	240	73x58x107
0000C01240F	<input checked="" type="checkbox"/>	240	73x58x107

240 lt bins available while stocks last

Polyethylene bin with cover, bag stretcher, pedal and axial wheels ø 200 mm



REF.	NOTES	CAPACITY (L)	SIZE (cm) ↓ ↓ ↓
0000C02120D	<input type="checkbox"/>	120	55x48x93
0000C02120F	<input checked="" type="checkbox"/>	120	55x48x93
0000C02240D	<input type="checkbox"/>	240	73x58x107
0000C02240F	<input checked="" type="checkbox"/>	240	73x58x107

240 lt bins available while stocks last



BINS FOR SEPARATE WASTE COLLECTION

SANITARY BINS

WASTE TROLLEYS

PAPER HOLDERS

Desy is a bin for lady's sanitary towels with a modern design, that fulfils the specific needs of hygiene.

Also available with the **10 l capacity**, in the free-standing version and in the wall version for narrow bathrooms.



Delivered already assembled and packed one piece per box.



Desy 10 L bin



Desy 10 L wall mounted bin



Cover opening with a peculiar design that inhibits the sight of the content and prevents the release of any odour.



It is equipped with bag stretcher and cage for deodorant pills.



It has a particular fixing system of the cover which allows to remove it very easily and quickly, if necessary.

Desy bins

DESY - plastic bin 10 L with cover and pedal for sanitary towels



REF.	NOTES	CAPACITY (L)	SIZE (cm) ↓ ↓ ↓
0000C02010DE		10	35,7x18x43,5

Advised bag size: 45x55 cm

DESY - plastic bin 10 L for sanitary towels with cover, pedal and fixing kit for wall



REF.	NOTES	CAPACITY (L)	SIZE (cm) ↓ ↓ ↓
0000C02910DE		10	35,7x18x43,5

Advised bag size: 45x55 cm

DESY - plastic bin with cover and pedal for sanitary towels

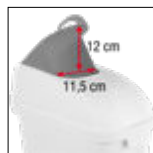

REF.	NOTES	CAPACITY (L)	SIZE (cm) ↓ ↓ ↓
0000C02017DE		17	42x20x54
0000C02023DE		23	42x20x65

Advised bag size: 50x60 cm for 17 lt and 55x65 cm for 23 lt

Rilsan coated wall-fixing support for Sally and Desy bins



REF.	NOTES
R2180400	only for Sally-Desy 17 L



BINS FOR SEPARATE WASTE COLLECTION

SANITARY BINS

WASTE TROLLEYS

PAPER HOLDERS

Kiddy bins

KIDDY - plastic bin 23 lt with cover and pedal for kids' diapers

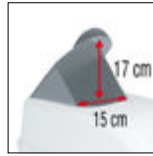

REF.	NOTES	SIZE (cm) ↓ ↓ ↓
0000C03023D		42x20x67

Ideal for nurseries and kindergartens - Advised bag size: 55x65 cm

Patty for Lady bins

PATTY FOR LADY - plastic bin 25 L with cover and pedal for sanitary towels



REF.	NOTES	SIZE (cm) ↓ ↓ ↓
0000C02025D		32x34x52

Advised bag size: 50x60 cm

Delta: high capacity and space-saving size in just one trolley

Delta plastic bag holding trolley has a rounded and smooth design and is easy to clean.

It is equipped with a handy and ergonomic push-bar and a wide foot-operated pedal opening of the cover.

Maximum flexibility: available also in the version 2x60 L and 1x60L + 2x30 L for a much more efficient waste collection.

The bag holding trolley is now available in the **Delta Compact** version, ideal for the small and narrow spaces thanks to its space-saving size.



DELTA

DELTA COMPACT

Delta and Delta Compact are available in grey and can be equipped with a multipurpose carry basket and useful hooks and handle holders.



Version 2x60 L



Version 1x60 L + 2x30 L



Versions with 4 wheels



Versions with 2 wheels and 2 feet



Delta bag holding trolleys

DELTA - white plastic bag holding trolley 120 L complete with 4 wheels, pedal and coloured cover



DELTA - white plastic bag holding trolley 120 L complete with 2 wheels, 2 feet, pedal and coloured cover



REF.	NOTES	SIZE (cm) ↓ ↓ ↓
0000C04120D	with white cover	64x50x99
0000C04121D	with blue cover	64x50x99
0000C04122D	with red cover	64x50x99
0000C04123D	with yellow cover	64x50x99
0000C04124D	with green cover	64x50x99

With surcharge available in single package - To order the single bin, simply add the prefix 0001 on the front of the standard code. E.g. 0001C04120D - Advised bag size: 75x110 cm

REF.	NOTES	SIZE (cm) ↓ ↓ ↓
0000C04220D	with white cover	64x50x99
0000C04221D	with blue cover	64x50x99
0000C04222D	with red cover	64x50x99
0000C04223D	with yellow cover	64x50x99
0000C04224D	with green cover	64x50x99

With surcharge available in single package - To order the single bin, simply add the prefix 0001 on the front of the standard code. E.g. 0001C04220D - Advised bag size: 75x110 cm



BINS FOR SEPARATE WASTE COLLECTION

SANITARY BINS

WASTE TROLLEYS

PAPER HOLDERS

DELTA - white plastic bag holding trolley 120 L complete with 4 wheels, pedal and cover



REF.	NOTES	SIZE (cm) ↓ ↓ ↓
2000CO4120D	with 2x60 L bag holder	64x50x99
3000CO4120D	with 1x60 L + 2x30 L bag holder	64x50x99

Advised bags size: 75x110 cm

DELTA - white plastic bag holding trolley 120 L complete with 2 wheels, 2 feet, pedal and cover



REF.	NOTES	SIZE (cm) ↓ ↓ ↓
2000CO4220D	with 2x60 L bag holder	64x50x99
3000CO4220D	with 1x60 L + 2x30 L bag holder	64x50x99

Advised bags size: 75x110 cm

DELTA COMPACT - white plastic bag holder, with 2 wheels and 2 feet, pedal and coloured cover



REF.	NOTES	SIZE (cm) ↓ ↓ ↓
0003CO4220D		64x50x80

Ideal to be placed under worktops - Advised bag size: 75x110 cm

Components for Delta trolleys

Plastic base with 2 wheels ø 125 mm for Delta trolley



REF.	NOTES
P290981D	for trolleys with 4 wheels
P290989D	for trolleys with wheels and feet

Aluminium rod (connecting pedal/cover) with plastic closing connections for Delta trolley



REF.	NOTES
P290977D	for Delta
P290979D	for Delta Compact

Plastic bag holder for Delta trolley



REF.	NOTES
P290978D	120 lt
P390986D	2x60 L
P390987D	60 lt + 2x30 lt



BINS FOR SEPARATE WASTE COLLECTION

SANITARY BINS

WASTE TROLLEYS

PAPER HOLDERS

Plastic cover for Delta bag holding trolley



REF.	NOTES
P290976A	
P290976B	
P290976C	
P290976D	
P290976F	

Please, require also no. 2 shock absorbing pistons art. P190908U for a perfect soft closing

Set of two feet (right and left) for Delta trolley



REF.	NOTES
P190974D	

Plastic pedal for Delta trolley



REF.	NOTES
P190973D	

Pedal rod for Delta trolley



REF.	NOTES
P190972D	

Accessories for Delta bag holding trolleys

Shock absorbing piston for a soft closing of the cover



REF.	NOTES
P190908U	

Plastic carry basket for Delta bag holding trolley



REF.	NOTES
P190975N	



BINS FOR SEPARATE WASTE COLLECTION

SANITARY BINS

WASTE TROLLEYS

PAPER HOLDERS

"X" trolleys

Chromed X-trolley with square bag holder 120 L and pirouetting wheels ø 80 mm



REF.	NOTES	SIZE (cm) ↓ ↓ ↓
8042		62x60x103

Chromed X-trolley with removable square bag holder 120 L and pirouetting wheels ø 80 mm



REF.	NOTES	SIZE (cm) ↓ ↓ ↓
8042/1		62x60x103

ROBBY - painted X-trolley with round bag holder 120 L, elastic and pirouetting wheels ø 80 mm



REF.		PCK	SIZE (cm) ↓ ↓ ↓
8045A		5	58x56x102
8045B		5	58x56x102
00018045A		1	58x56x102
00018045B		1	58x56x102

Chromed X-trolley with round bag holder 120 L, elastic and pirouetting wheels ø 80 mm



REF.	PCK	SIZE (cm) ↓ ↓ ↓
8070	5	58x56x102
00018070	1	58x56x102

Chromed X-trolley with round bag holder 120 L, elastic, plastic cover, pedal set and pirouetting wheels ø 80 mm



REF.	PCK	SIZE (cm) ↓ ↓ ↓
8075	3	58x56x102
00018075	1	58x56x102

Chromed bag holding trolley for outdoor use with round bag holder 120 L, elastic and wheels ø 175 mm



REF.	NOTES	SIZE (cm) ↓ ↓ ↓
8076		58x58x102

It is possible to fix the chromed basket 50x20x13 cm art. 8205/2

Chromed bag holding trolley for outdoor use with round bag holder 120 L, elastic, wheels ø 175 mm, plastic cover and pedal



REF.	NOTES	SIZE (cm) ↓ ↓ ↓
8077		58x58x102

Chromed bag holding trolley for outdoor use with round bag holder 70 L, elastic, wheels ø 175 mm, plastic cover and pedal



REF.	NOTES	SIZE (cm) ↓ ↓ ↓
8077/1		58x48x102

Rilsan bag holding trolley for outdoor use with round bag holder 120 L, elastic, wheels ø 175 mm, plastic cover and pedal



REF.	NOTES	SIZE (cm) ↓ ↓ ↓
R8377		57x52x91

Available while stocks last

Trolleys for outdoor use



BINS FOR SEPARATE WASTE COLLECTION

SANITARY BINS

WASTE TROLLEYS

PAPER HOLDERS

Painted bag holding trolley complete with three stairs climbing wheels for street cleaning



REF.	NOTES
7450/2	

It can be equipped with plastic bin AtloxFit 25 lt - It can be used with plastic bin 120 L art. 0000C01120F

Galvanized bag holding trolley complete with wheels ø 260 mm for street cleaning



REF.	NOTES	SIZE (cm)
8050		77x68x114

It is used with bin 120 L art. 0000C01120F - It can be equipped with plastic bin AtloxFit 25 lt

Galvanized bag holding trolley with bag holder 120 L and wheels ø 260 mm for street cleaning



REF.	NOTES	SIZE (cm)
8040		77x68x114

It can be equipped with plastic bin AtloxFit 25 lt

Painted bag holding trolley complete with wheels ø 260 mm for street cleaning



REF.	NOTES	SIZE (cm)
8450		77x68x114

It can be equipped with plastic bin AtloxFit 25 lt - It can be used with plastic bin 120 L art. 0000C01120F

Painted bag holding trolley complete with bag holder 120 L and wheels ø 260 mm for street cleaning



REF.	NOTES	SIZE (cm)
8440		77x68x114

It can be equipped with plastic bin AtloxFit 25 lt

TREND - free standing bag holder 70 L with elastic and yellow plastic cover



REF.	NOTES
8174C	height 72 cm

TREND - free standing bag holder 70 L with elastic, yellow plastic cover, wheels ø 35 mm and bag support



REF.	NOTES
8175	height 76 cm

Green bag holder for outdoor use, without cover



REF.	NOTES
8191F	height 99 cm



BINS FOR SEPARATE WASTE COLLECTION

SANITARY BINS

WASTE TROLLEYS

PAPER HOLDERS

Multi-sort waste separation trolleys

Chromed trolley tube Ø 25 cm with double bag holder 2x120 L and pirouetting wheels ø 100 mm



REF.	NOTES	SIZE (cm) ↓ ↓ ↓
8049		67x60x110

TEDDY 8083 - chromed trolley



REF.	NOTES	SIZE (cm) ↓ ↓ ↓
8083X		82x51x105

ECOLOGY 3100 - chromed trolley



REF.	NOTES	SIZE (cm) ↓ ↓ ↓
3100		84x58x110

Bags and covers not included

Components for chromed waste trolleys

Bag fixing elastic



REF.	NOTES
8054	for trolleys art.8045, 8070, 8075, 8076, 8077, 8077/1, R8377, 8040 and 8440
8054/1	for Trend and laundry trolleys

Pedal set with rods



REF.	NOTES
8074	for Robby trolley art. 8075
8079	for free standing trolleys art. 8076 and 8077
8079/1	for free standing trolley art. 8077/1

Plastic tray for the base of the trolleys art. 8049, Teddy 8090X-8098X and Panda



REF.	NOTES	SIZE (cm) ↓ ↓ ↓
8227		39,5x59x2,5

Galvanized bag holder 120 lt with elastic for street cleaning's trolley



REF.	NOTES
Z2060104	galvanized
V2060104F	painting green

Container holder 25 lt for street cleaning trolley



REF.	NOTES
Z2060103	galvanized
V2060103F	painting green

Plastic clip for bag fixing



REF.	NOTES
8220/1	

Plastic bag fixing clip



REF.	NOTES
8220A	

For the Teddy and Ecology trolley components and accessories see the multipurpose trolley range



BINS FOR SEPARATE WASTE COLLECTION

SANITARY BINS

WASTE TROLLEYS

PAPER HOLDERS

Accessories for chromed waste trolleys

Round plastic cover with hinges fitting trolleys art. 8045, 8070, 8075, 8076, 8077, 8077/1, R8377, 8040 and 8440



REF.	NOTES
8055B	

Square plastic cover with hinges fitting "X" trolley art. 8042



REF.	NOTES
8056DB	

Round plastic cover with hinges fitting bag holding trolley Trend



REF.	NOTES
8400A	
8400B	
8400C	

Round metal cover for bag holder code 8191F for outdoor use, complete with screws



REF.	NOTES
8092F	

Plastic coated basket for trolleys art. 8042, 8042/1, 8045, 8070 and 8075



REF.	NOTES	SIZE (cm)
8053		41,5x22,5x21 ↓ ↓ ↓

Chromed basket for Teddy and art. 8076 trolleys



REF.	NOTES	SIZE (cm)
8205/2		50x20x13 ↓ ↓ ↓

Chromed frame for basket art. 8205 for "X" trolleys art. 8042, 8042/1, 8045 and 8070



REF.	NOTES
8071	

Plastified side panel with pockets fitting trolleys art. 8042, 8042/1, 8045, 8070, 8075 and 8043



REF.	NOTES	SIZE (cm)
8058		48x74 ↓ ↓ ↓

Chromed paper holder for trolleys art. 8045, 8070, 8042 and 8042/1



REF.	NOTES
8072	

Chromed basket fitting vertical frame art. 8071



REF.	NOTES	SIZE (cm)
8205		43,5x26x16 ↓ ↓ ↓

Ash-tray box for trolleys art. 8042/1



REF.	NOTES
8073B	

Wheel ø 80 mm with turning plate complete with screws



REF.	NOTES
23011300	To be applied to street cleaning trolleys

For the Teddy and Ecology trolley components and accessories see the multipurpose trolley range



BINS FOR SEPARATE WASTE COLLECTION

SANITARY BINS

WASTE TROLLEYS

PAPER HOLDERS

Alpha and Morgan versions designed to offer maximum flexibility and efficiency in waste collection operations.

Products partly made with plastic components certified PSV - Second Life Plastic.



Alpha trolleys

ALPHA 1102 - with two 120 lt bag holders



REF.	SIZE (cm)
0000MA1102U00	97x58x102

ALPHA 2107 - with two 120 lt bag holders + 150 lt bag holder



REF.	SIZE (cm)
0500MA2107U00	126x58x102
Trolley dimensions with closed foldable bag holder 72x58x145 cm	

ALPHA 5143 - with two 120 lt bag holders + 150 lt bag holder



REF.	SIZE (cm)
0300MA5143U00	133x58x102
Trolley dimensions with closed foldable bag holder 100x58x145 cm	

ALPHA 0901006 - with two 120 lt bag holders + two 150 lt bag holders



REF.	SIZE (cm)
MA0901006U000	146x58x102
Trolley dimensions with closed foldable bag holder 101x58x145 cm	

ALPHA 7103 - with two 150 lt bag holders



REF.	SIZE (cm)
0000MA7103U00	105x58x102

ALPHA 8125 - with three 150 lt bag holders



REF.	SIZE (cm)
1000MA8125U00	146x58x102

ALPHA 0901019 - with four 150 lt bag holders



REF.	SIZE (cm)
MA0901019U000	194x58x102

Bags, cover for bag holder 120 L and pedal set not included



BINS FOR SEPARATE WASTE COLLECTION

SANITARY BINS

WASTE TROLLEYS

PAPER HOLDERS

Morgan trolleys

ALPHA 0901005 - with three 150 lt bag holders



REF.	SIZE (cm)
MA0901005U002	146x58x102

AVAILABLE TO ORDER

MORGAN 1010 - with two 120 lt bag holders



REF.	SIZE (cm)
0000MP1010A	93x57x104

MORGAN 1030 - with two 120 lt bag holders



REF.	SIZE (cm)
0000MP1030U	102x57x104

Painted metal paper holders

Painted white metal wall paper holder



REF.	NOTES	SIZE (cm)
8171		21x41x34

For maximum size rolls ø 32x29 cm

Painted white metal standing paper holder on wheels



REF.	NOTES	SIZE (cm)
8172		62x49x103

For maximum size rolls ø 35x36 cm

Plastic paper holders

Closed plastic wall paper holder



REF.	NOTES	SIZE (cm)
8571		31,5x36x34

Closed plastic standing paper holder on wheels



REF.	NOTES	SIZE (cm)
8272		51,5x47x91

For maximum size rolls ø 42x42cm

Painted bag holder 120 L complete with basket (39x12x10 cm), clip with spring and wheels ø 175 mm



REF.	NOTES	SIZE (cm)
8167		44x45x95

Bags, cover for bag holder 120 L and pedal set not included

Housekeeping trolleys

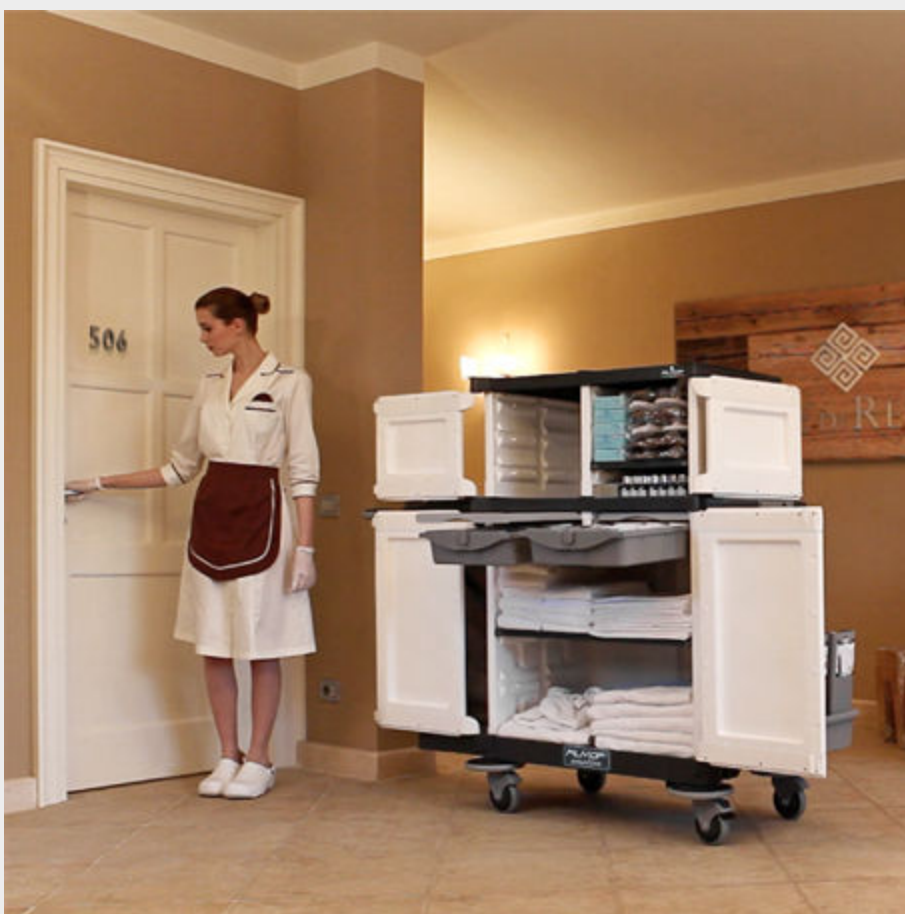

Morgan Hotel Elegance

Alpha Hotel

Emotion

KeepHotel

Trolleys for laundry collection

Silver

HOUSEKEEPING
TROLLEYS





**MORGAN HOTEL
ELEGANCE**

ALPHA HOTEL

EMOTION

KEEPHOTEL

TROLLEYS FOR LAUNDRY
COLLECTION

SILVER

The **Morgan Hotel Elegance** line is elegant, smart, simple and fits any environment, satisfying any cleaning need and request in hotels. Characterized by Rilsan coated vertical frames, rich and elegant wooden shelves made of beech, brown plastified panels, easy to remove and periodically clean.

The trolley can be equipped with a wide and complete range of accessories ideal to meet any cleaning need: it can be used for the change of towels and linen, for the collection of dirty towels and linen by means of the specific trolleys for laundry collection, for the cleaning of rooms and bathrooms and for waste collection.

Light series

The housekeeping trolleys of the **Light series** are distinguished by their modern design, lightness and easy handling. The whole range also offers utmost capacity.



Some details about the Morgan Hotel Elegance line:



Plastic sliding drawer 10 and 22 L with locking key for guest amenities



Handy plastic baskets



System for the separate waste collection



Bathrobe holder kit



Supplied as standard with useful door stopper (Code P130001Q).

Morgan Hotel Trolleys can be used with several wet mopping systems:



Top-Down® system



Bucket 22 L and its special mop



Master Lux wet mopping system



Unilav wet mopping system

Accessories



Roll-up front covering: handy and safe



Coupling device to connect the laundry trolley with dirty linen to the Morgan Hotel trolley



MORGAN HOTEL ELEGANCE

ALPHA HOTEL

EMOTION

KEEPHOTEL

TROLLEYS FOR LAUNDRY COLLECTION

SILVER

Light series

MORGAN HOTEL LIGHT 4374 - with two bag holders + 2 shelves + 2 drawers



REF.	SIZE (cm)
0000HP4374U	165x55x130

Recommended for 14-16 rooms - Max. load capacity 30 kg/shelf

MORGAN HOTEL LIGHT 4373 - with bag holder + 2 shelves + 2 drawers



REF.	SIZE (cm)
0000HP4373U	135x55x130

Recommended for 14-16 rooms - Max. load capacity 30 kg/shelf

MORGAN HOTEL LIGHT 4274 - with two bag holders + 2 shelves + 2 drawers



REF.	SIZE (cm)
0000HP4274U	155x55x130

Recommended for 14-16 rooms - Max. load capacity 30 kg/shelf - Trolley dimensions with closed bag holders 114x55x144 cm

MORGAN HOTEL LIGHT 4273 - with bag holder + 2 shelves + 2 drawers



REF.	SIZE (cm)
0000HP4273U	128x55x130

Recommended for 14-16 rooms - Max. load capacity 30 kg/shelf

MORGAN HOTEL LIGHT 4273 - with bag holder + 2 shelves + 2 drawers + storage pockets



REF.	SIZE (cm)
0002HP4273U	128x55x130

MORGAN HOTEL 600 - with 3 shelves

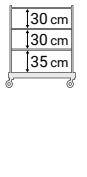

REF.	SIZE (cm)
0000HP3300U	88x49x130

Advised for 10-12 room service - Max. load capacity 30 kg/shelf

MORGAN HOTEL 611 - with 3 shelves



REF.	SIZE (cm)
0000HP3301U	88x49x130

Advised for 10-12 room service - Max. load capacity 30 kg/shelf

MORGAN HOTEL 612 - with bag holder + 3 shelves



REF.	SIZE (cm)
0000HP3302U	126x52x130

Advised for 10-12 room service - Max. load capacity 30 kg/shelf

MORGAN HOTEL 613 - with two bag holders + 3 shelves



REF.	SIZE (cm)
0000HP3303U	166x52x130

Advised for 10-12 room service - Max. load capacity 30 kg/shelf

⚠ FOR LINE 600 AND 800, BAGS NOT INCLUDED



MORGAN HOTEL
ELEGANCE

ALPHA HOTEL

EMOTION

KEEPHOTEL

TROLLEYS FOR LAUNDRY
COLLECTION

SILVER

Line 800

MORGAN HOTEL 614 - with two bag holders
+ 3 shelves + drawer



REF.	SIZE (cm)
0000HP4304U	166x52x130

Advised for 10-12 room service - Max. load capacity 30 kg/shelf

MORGAN HOTEL 800 - with 3 shelves



REF.	SIZE (cm)
0000HP3360U	102x49x130

Recommended for 14-16 rooms - Max. load capacity 30 kg/shelf

MORGAN HOTEL 811 - with 3 shelves



REF.	SIZE (cm)
0000HP3361U	102x49x130

Recommended for 14-16 rooms - Max. load capacity 30 kg/shelf

MORGAN HOTEL 812 - with bag holder
+ 3 shelves



REF.	SIZE (cm)
0000HP3362U	140x52x130

Recommended for 14-16 rooms - Max. load capacity 30 kg/shelf

MORGAN HOTEL 813 - with two bag holders
+ 3 shelves



REF.	SIZE (cm)
0000HP3363U	178x52x130

Recommended for 14-16 rooms - Max. load capacity 30 kg/shelf

MORGAN HOTEL 814 - with two bag holders
+ 3 shelves + 2 drawers



REF.	SIZE (cm)
0000HP4364U	177x52x130

Recommended for 14-16 rooms - Max. load capacity 30 kg/shelf

MORGAN HOTEL 815 - with bag holder
+ 3 shelves + storage pockets



REF.	SIZE (cm)
0000HP3365U	140x52x130

Recommended for 14-16 rooms - Max. load capacity 30 kg/shelf

MORGAN HOTEL 816 - with bag holder
+ 3 shelves + 2 drawers + storage pockets



REF.	SIZE (cm)
0000HP4366U	140x52x130

Recommended for 14-16 rooms - Max. load capacity 30 kg/shelf

MORGAN HOTEL 817 - with bag holder
+ 3 shelves + multipurpose pockets



REF.	SIZE (cm)
0000HP3367U	140x52x130

Recommended for 14-16 rooms - Max. load capacity 30 kg/shelf

⚠ FOR LINE 600 AND 800, BAGS NOT INCLUDED

Housekeeping trolleys



MORGAN HOTEL ELEGANCE

ALPHA HOTEL

EMOTION

KEEPHOTEL

TROLLEYS FOR LAUNDRY COLLECTION

SILVER

MORGAN HOTEL 818 - with bag holder + 3 shelves + 2 drawers + multipurpose pockets



118 cm
30 cm
35 cm

REF.	SIZE (cm)
	↓ ↓ ↓
0000HP4368U	140x52x130
Recommended for 14-16 rooms - Max. load capacity 30 kg/shelf	

MORGAN HOTEL 851 - with bag holder + 3 shelves



30 cm
30 cm
35 cm

REF.	SIZE (cm)
	↓ ↓ ↓
0000HP3341U	104x52x130
Suggested for 6 to 8 rooms - Maximum load capacity of each shelf: 15 kg	

MORGAN HOTEL 852 - with bag holder + 3 shelves



30 cm
30 cm
35 cm

REF.	SIZE (cm)
	↓ ↓ ↓
0000HP3342U	140x52x130
Suggested for 6 to 8 rooms - Maximum load capacity of each shelf: 15 kg	

Trolleys for laundry collection

MORGAN HOTEL 853 - with bag holder + 3 shelves + storage pockets



30 cm
30 cm
35 cm

REF.	SIZE (cm)
	↓ ↓ ↓
0000HP3343U	104x52x130
Suggested for 6 to 8 rooms - Maximum load capacity of each shelf: 15 kg	

LAUNDRY TROLLEY 3100 - with fabric bag



REF.	SIZE (cm)
	↓ ↓ ↓
0000HP3100U	88x49x88

LAUNDRY TROLLEY 3110 - with fabric bag with cover



REF.	SIZE (cm)
	↓ ↓ ↓
0000HP3110U	88x49x88
Available also in grey version with rubber wheels ø 125 mm and bumpers ø 200 mm art. 0000HP3110Q5	

LAUNDRY TROLLEY 3140 - with fabric bag with cover + bag holder



REF.	SIZE (cm)
	↓ ↓ ↓
0000HP3140U	126x52x108
Polyester bag capacity 150 l, white with blue stripe; to be ordered separately	

LAUNDRY TROLLEY 3101 - with fabric bag



REF.	SIZE (cm)
	↓ ↓ ↓
0000HP3101U	105x49x105

LAUNDRY TROLLEY 3103 - with fabric bag with zip



REF.	SIZE (cm)
	↓ ↓ ↓
0000HP3103U	88x49x152,5

⚠ FOR LINE 600 AND 800, BAGS NOT INCLUDED



MORGAN HOTEL ELEGANCE

ALPHA HOTEL

EMOTION

KEEPHOTEL

TROLLEYS FOR LAUNDRY COLLECTION

SILVER

Components for Morgan Hotel Elegance trolleys

Short plastic base



REF.	NOTES	SIZE (cm) ↓ ↓ ↓
P202008U	with wheels ø 125 mm	92x49
P202012U	with rubber wheels ø 150 mm	92x49

Long plastic base



REF.	NOTES	SIZE (cm) ↓ ↓ ↓
P202058U	with wheels ø 125 mm	105x49
P202063U	with rubber wheels ø 150 mm	105x49

Large plastic base for Light series



REF.	NOTES
P202051U	with ø 125 mm wheels and ø 130 mm bumpers
P202075U	with ø 150 mm rubber wheels and ø 130 mm bumpers

Supporting plastic plate with wheel



REF.	NOTES
P314001U	with wheel ø 125 mm
P314005U	with rubber wheel ø 125 mm

Supporting plastic plate with wheel and bumpers ø 200 mm



REF.	NOTES
P414001U	with wheel ø 125 mm
P414005U	with rubber wheel ø 125 mm

Supporting plate with wheel for Light serie



REF.	NOTES
P514000U	with wheel ø 125 mm
P514005U	with rubber wheel ø 125 mm

Supporting plastic plate for bucket 10 and 20 lt fitting Morgan base

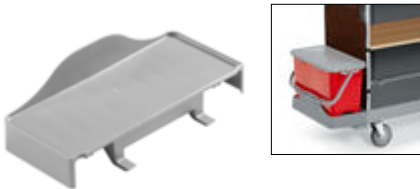

REF.	NOTES	SIZE (cm) ↓ ↓ ↓
P064000A		22x48x15
P064000U		22x48x15

Base extension for Alpha trolleys and for the bag supporting plastic plate of the Morgan Hotel Elegance trolleys



REF.	NOTES	SIZE (cm) ↓ ↓ ↓
P165000U	without castors	22x48
P065060U	with two wheels ø 125 mm and 2 blockings plugs	22x48

Rilsan coated vertical frame, 111 cm high, for Hotel trolleys 600 and 800



REF.	NOTES
R1030122	

Rilsan vertical frame with 2 bag holder retaining clips for Light series



REF.	NOTES
R2030161	

Rilsan coated vertical frame for laundry collection trolley



REF.	NOTES
R1030113	for art. 0000HP3100U and 0000HP3110U
R1030142	for art. 0000HP3140U
R1030144	for art. 0000HP3101U
R1030146	for art. 0000HP3103U

Rilsan coated reinforcing rod



REF.	NOTES	SIZE (cm) ↓ ↓ ↓
R1230110		81
R1230111		68
R1230112		46
R1230113		66

Housekeeping trolleys



**MORGAN HOTEL
ELEGANCE**

ALPHA HOTEL

EMOTION

KEEPHOTEL

TROLLEYS FOR LAUNDRY
COLLECTION

SILVER

Wooden shelf



REF.	NOTES	SIZE (cm) ↓ ↓ ↓
L0220013	for line 800	85,5x46
L0220014	for line 600	72,5x46
L0220015	for trolleys 851, 852 and 853	50x46

Wooden shelf with slots for one plastic sliding drawer



REF.	NOTES	SIZE (cm) ↓ ↓ ↓
L4220013	for line 800	85,5x46
L4220014	for line 600	72,5x46
L4220015	for trolleys 851, 852 and 853	50x46

Wooden shelf with slots for two plastic drawers



REF.	NOTES	SIZE (cm) ↓ ↓ ↓
L5220013	for line 800	85,5x46

Fixing screw set for shelves



REF.	NOTES
0000SM00602	for 3 shelves (12 screws)
0000SM00603	for 2 shelves (8 screws)
0000SM00607	for 1 shelf (4 screws)

Galvanized steel rod 102 cm to fix the back panel



REF.	NOTES
I1900050	

Plastic sliding drawer without locking key

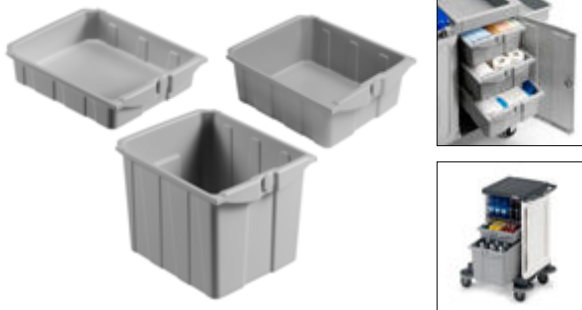

REF.	NOTES	CAPACITY (L)	SIZE (cm) ↓ ↓ ↓
P1229909U	internal dimensions 41x34x9,5 cm	10	46,5x37,5x11
P1229906U	internal dimensions 40,5x34x16 cm	22	46,5x37,5x17
P1229907U	internal dimensions 40x34x33,5 cm	40	46,5x37,5x35

Plastic sliding drawer with locking key

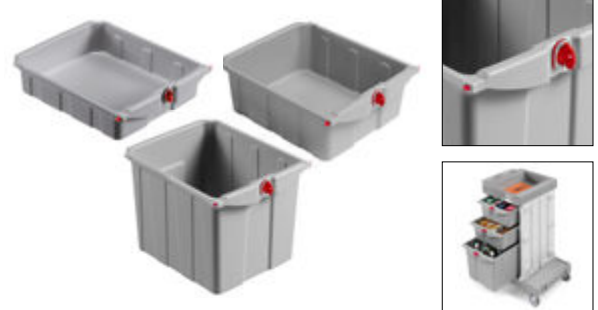

REF.	NOTES	CAPACITY (L)	SIZE (cm) ↓ ↓ ↓
P2229909U	internal dimensions 41x34x9,5 cm	10	46,5x37,5x11
P2229906A	internal dimensions 40,5x34x16 cm	22	46,5x37,5x17
P2229906B	internal dimensions 40,5x34x16 cm	22	46,5x37,5x17
P2229906U	internal dimensions 40,5x34x16 cm	22	46,5x37,5x17
P2229907U	internal dimensions 40x34x33,5 cm	40	46,5x37,5x35

Plastified and reinforced back and side panels (3 parts), brown and grey



REF.	NOTES	SIZE (cm) ↓ ↓ ↓
Q1400010G	for line 800	178x103,5
Q1400030G	for line 600	165x103,5

Plastified and reinforced back and side panels (3 parts) for Line 851 and 852, brown and grey



REF.	NOTES	SIZE (cm) ↓ ↓ ↓
Q1400130G		144x103,5

Full 3-sided grey reinforced plastic-coated cloth back, for Light series



REF.	NOTES
Q1400011E	



MORGAN HOTEL ELEGANCE	ALPHA HOTEL	EMOTION	KEEPHOTEL	TROLLEYS FOR LAUNDRY COLLECTION	SILVER
------------------------------	-------------	---------	-----------	---------------------------------	--------

Plastified and reinforced panel, brown and grey



REF.	NOTES	SIZE (cm)
Q1400090G	for line 800	87x103,5 ↓ ↓ ↓
Q1400110G	for line 600	73x103,5

Plastified and reinforced back and one side for seires 853, brown and grey



REF.	NOTES	SIZE (cm)
Q1400210G		97x103,5 ↓ ↓ ↓

Plastified and reinforced smooth side panel (2 pcs), brown and grey



REF.	NOTES	SIZE (cm)
Q1400050G		47x103,5 ↓ ↓ ↓

Plastified and reinforced side panel with pockets, brown and grey



REF.	NOTES	SIZE (cm)
Q0400070G		47x103,5 ↓ ↓ ↓

Multipurpose pocket for hotel disinfection



REF.	NOTES	SIZE (cm)
Q0400075G		47x103,5 ↓ ↓ ↓

Brown plastified bag for laundry collection with zip



REF.	NOTES	CAPACITY (L)
Q0400101G	300 lt	300
Q0400102G	200 lt	200

Brown plastified bag 200 Lt for laundry collection trolley with zip and closure



REF.	NOTES
Q0400103G	

Brown plastified bag 600 Lt for laundry collection trolley with front zip



REF.	NOTES
Q0400122P	

90l self-standing bag with strap tape system



REF.	NOTES
0000AT0185E	

For Morgan Hotel Light trolley bag holder

Plastic bag holder 120 lt with push-bar, bag-stretchers and reinforcements



REF.	NOTES
P816010U	

Plastic bag holder 2x60 Lt with push-bar, bag-stretchers and reinforcements



REF.	NOTES
P516010U	

Rilsan 90 lt bag holder for Morgan Hotel Light



REF.	NOTES
R2060081	



**MORGAN HOTEL
ELEGANCE**

ALPHA HOTEL

EMOTION

KEEPHOTEL

TROLLEYS FOR LAUNDRY
COLLECTION

SILVER

Accessories for Morgan Hotel Elegance trolleys

Plastic divider for drawer 10 L



REF.	NOTES
0000SM00227D	9 compartments
0000SM00228D	12 compartments

Set of 1 big divider 39 cm + 1 medium divider 32 cm for plastic sliding drawer 22 L

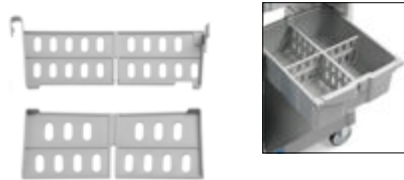

REF.	NOTES
0000SM00213U	

Set of 1 big divider 39 cm + 3 small dividers 16 cm for plastic sliding drawer 22 L

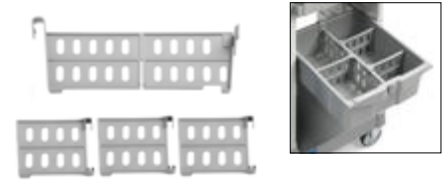

REF.	NOTES
0000SM00214U	

Brown plastified front covering



REF.	NOTES
Q0400220G	for line 600
Q0400230G	for line 800 (except versions 851-852-853)

Brown plastified front covering with elastic



REF.	NOTES
Q0400221G	for line 600
Q0400231G	for line 800 (except versions 851-852-853)

Plastic cover for bag holder 120 L with storage room, check-list holder and lock

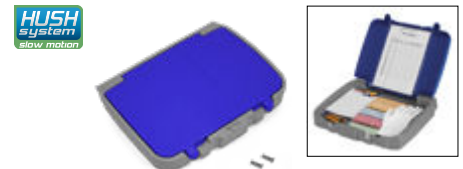

REF.	NOTES
P291920UA	
P291920UB	
P291920U	

Please, require also no. 2 shock absorbing pistons art. P190908U for a perfect soft closing

Shock absorbing piston for a soft closing of the cover



REF.	NOTES
P190908U	

Plastic tray for guest amenities



REF.	NOTES	SIZE (cm)
P219004U		28x43x9
P219005U		55x43x9

Plastified tray for guest amenities

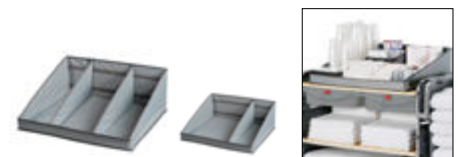

REF.	NOTES	SIZE (cm)
Q0400104		66x46
Q0400117		43x46

Rilsan coated coupling device to connect the laundry trolley to the Morgan Hotel trolleys

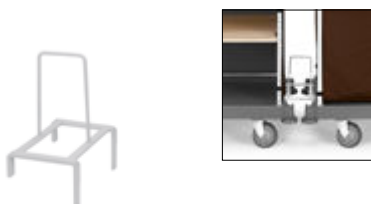

REF.	NOTES
R1180050	

Bathrobe holder kit with pockets complete with double fixing clip with screws



REF.	NOTES
Q1400118U	

Recommended with bag supporting plastic plate

Rilsan coated hand towels and toilet paper dispenser



REF.	NOTES
R1900050	



MORGAN HOTEL ELEGANCE

ALPHA HOTEL

EMOTION

KEEPHOTEL

TROLLEYS FOR LAUNDRY COLLECTION

SILVER

Rilsan coated external vertical frame h 109 cm complete with 2 fixing clips (special shaped in the lower part)



REF.	NOTES
R2030106	

Side plastic basket for Morgan Hotel fitting vertical frame ref. R2030106



REF.	NOTES
P119002U	internal sizes 18,5x49,5x11 cm

Rilsan coated support 70 L with bag stretcher fitting special shaped vertical frame



REF.	NOTES
R2060080	

Grey waste collection bin 16 L with handle

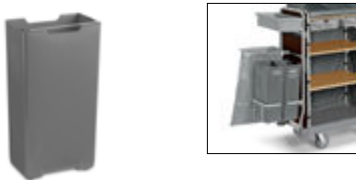

REF.	NOTES	CAPACITY (L)	SIZE (cm)
8168U		16	16x26x50

Rilsan coated holder for plastic bin 16 L, fitting special shaped vertical frame

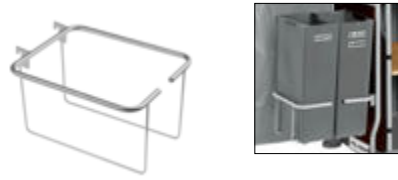

REF.	NOTES
R2200050	

Rilsan coated vertical frame 52 cm high complete with 4 fixing clips



REF.	NOTES
R3030135	

Rilsan coated basket holder for basket art. P1191100U fitting vertical frame art. R2030135



REF.	NOTES
R2200051	

Side plastic basket



REF.	NOTES
P1191100U	internal sizes 22x49x11,5 cm

Rilsan coated bucket holder for buckets 10 and 20 L fitting Morgan vertical frame and Alpha trolley

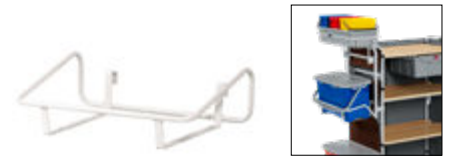

REF.	NOTES
R2200040	



Alpha Hotel: comfortable and functional service trolley

Alpha Hotel trolleys have a plain and simple design to fit any environment.

Partially made of PSV - Second Life Plastic - certified plastic components, they are available in open versions or with closing doors for maximum safety.

The Alpha Hotel range features utmost care of all details and a specific design conceived to ensure practicality, efficiency and functionality.



VERSATILE

- Can be configured according to your specific needs
- Customisable with components and accessories



MODERN DESIGN

- Smooth surfaces and attention to details
- Customisable with graphics, pictures and logo



HYGIENIC

- Smooth surfaces for easy cleaning
- Safety lock with universal key



SPACIOUS

- No waste of space
- Highest storage capacity



ERGONOMIC

- Lightweight and easy to move
- Designed to facilitate handling



Sliding tray with safety locking key



GREEN CERTIFICATIONS

- **Carbon Footprint** Systematic Approach
- **PSV** - Plastic Second Life
- **EU Ecolabel** for some Alpha models



Innovative closing mechanism to work safe

Better functionality

The models with two storage units have a left opening door, for **convenience** and **practicality**.



MORGAN HOTEL ELEGANCE

ALPHA HOTEL

EMOTION

KEEPHOTEL

TROLLEYS FOR LAUNDRY
COLLECTION

SILVER

Organize your services and work better

The versions without central vertical frame ensure **high trolley capacity**, so that everything that may be needed for the job can be right at hand.

PATENTED SYSTEM



Versions without central vertical frame



Unhook the trolley and go

Thanks to **Link-Up, the new hook system** designed by Filmop, it will be possible to separate the bag holder compartment from the rest of the trolley with a simple click.

The **new independent waste collection unit** allows to move around more freely and comfortably during all waste or laundry disposal operations and to gain access easier to small and reduced areas, such as elevators, small hallways and laundries.

New baskets set for Alpha trolleys

The exclusive set of central trays for Alpha Hotel trolleys is an essential accessory to offer the **maximum convenience** and **safety**.

The practical set **doubles the storage capacity**, allowing you to further optimize your service trolley: it offers two open storage areas and two areas with **cover with locking key**, which can be organized according to your specific needs.

The set of central trays is characterized by a **well-finished design** in line with the **simple and elegant style** of the whole Alpha Hotel range of trolleys.





MORGANHOTEL ELEGANCE

ALPHA HOTEL

EMOTION

KEEPHOTEL

TROLLEYS FOR LAUNDRY
COLLECTION

SILVER

Open version trolleys

ALPHA HOTEL 2300-05 - with bag holder + basin + small shelf



REF.	SIZE (cm) ↓ ↓ ↓
0300HA2300U05	99x55x109
Suggested for 4 to 5 rooms - Maximum pull-out shelf capacity 15 kg	

ALPHA HOTEL 5300-06 - with bag holder + basins + small shelves



REF.	SIZE (cm) ↓ ↓ ↓
0300HA5300U06	142x55x109
Suggested for 8 to 10 rooms - Maximum pull-out shelf capacity 15 kg	

ALPHA HOTEL 5301-06 - with 2 bag holders + basins + small shelves



REF.	SIZE (cm) ↓ ↓ ↓
0500HA5301U06	177x55x109
Suggested for 8 to 10 rooms - Maximum pull-out shelf capacity 15 kg	

ALPHA HOTEL 5304-06 - with bag holder + basins + small shelves



REF.	SIZE (cm) ↓ ↓ ↓
0300HA5304U06	153x55x109
Suggested for 8 to 10 rooms - Maximum pull-out shelf capacity 15 kg	

ALPHA HOTEL 5302-98 - with basins + big shelf



REF.	SIZE (cm) ↓ ↓ ↓
0000HA5302U98	97x55x106
Suggested for 8 to 10 rooms - Maximum pull-out shelf capacity 30 kg	

ALPHA HOTEL 5400-98 - with bag holder + basins + big shelf



REF.	SIZE (cm) ↓ ↓ ↓
0300HA5300U98	142x55x109
Suggested for 8 to 10 rooms - Maximum pull-out shelf capacity 30 kg	

ALPHA HOTEL HR5300-98 Link-Up system - with bag holder + basins + big shelf



REF.	SIZE (cm) ↓ ↓ ↓
0300HR5300U98	153x55x109
Suggested for 8 to 10 rooms - Maximum pull-out shelf capacity 30 kg	

ALPHA HOTEL 5503006 - with bag holder + basins + big shelf



REF.	SIZE (cm) ↓ ↓ ↓
HA5503006U000	142x55x110
Suggested for 8 to 10 rooms - Maximum pull-out shelf capacity 30 kg	

ALPHA HOTEL 5301-98 - with 2 bag holders + basins + big shelf



REF.	SIZE (cm) ↓ ↓ ↓
0500HA5301U98	177x55x109
Suggested for 8 to 10 rooms - Maximum pull-out shelf capacity 30 kg	

⚠ BAGS NOT INCLUDED



MORGAN HOTEL ELEGANCE

ALPHA HOTEL

EMOTION

KEEPHOTEL

TROLLEYS FOR LAUNDRY
COLLECTION

SILVER

Closed version trolleys

ALPHA HOTEL 0603002 - with basins + small shelves



REF.	SIZE (cm) ↓ ↓ ↓
HA0603002U000	97x55x106

Suggested for 8 to 10 rooms - Maximum pull-out shelf capacity 15 kg

ALPHA HOTEL 0603005 - with basins + big shelf



REF.	SIZE (cm) ↓ ↓ ↓
HA0603005U000	97x55x106

Suggested for 8 to 10 rooms - Maximum pull-out shelf capacity 30 kg

ALPHA HOTEL 3300-05 - with bag holder + basin + small shelf

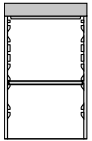

REF.	SIZE (cm) ↓ ↓ ↓
0300HA3300U05	99x55x109

Suggested for 4 to 5 rooms - Maximum pull-out shelf capacity 15 kg

ALPHA HOTEL 0603003 - with bag holder + basins + small shelves



REF.	SIZE (cm) ↓ ↓ ↓
HA0603003U000	142x55x109

Suggested for 8 to 10 rooms - Maximum pull-out shelf capacity 15 kg

ALPHA HOTEL HR0603003 Link-Up system - with bag holder + basins + small shelves



REF.	SIZE (cm) ↓ ↓ ↓
HR0603003U000	153x55x109

Suggested for 8 to 10 rooms - Maximum pull-out shelf capacity 15 kg

ALPHA HOTEL 5603003 - with bag holder + basins + small shelves



REF.	SIZE (cm) ↓ ↓ ↓
HA5603003U000	142x55x110

Suggested for 8 to 10 rooms - Maximum pull-out shelf capacity 15 kg

ALPHA HOTEL HR0603006 Link-Up system - with bag holder + basins + big shelf



REF.	SIZE (cm) ↓ ↓ ↓
HR0603006U000	153x55x109

Suggested for 8 to 10 rooms - Maximum pull-out shelf capacity 30 kg

ALPHA HOTEL 0603004 - with 2 bag holders + basins + small shelves



REF.	SIZE (cm) ↓ ↓ ↓
HA0603004U000	177x55x109

Suggested for 8 to 10 rooms - Maximum pull-out shelf capacity 15 kg

BAGS NOT INCLUDED



MORGAN HOTEL ELEGANCE

ALPHA HOTEL

EMOTION

KEEPHOTEL

TROLLEYS FOR LAUNDRY
COLLECTION

SILVER

Components for Alpha Hotel trolleys

Short plastic base for Alpha trolley



REF.	NOTES	SIZE (cm) ↓ ↓ ↓
P059011U	with wheels ø 100 mm	66x52
P059031U	with rubber wheels ø 125 mm	66x52
P059061U	with wheels ø 125 mm	66x52
P159061U	with five ø 125 mm wheels	66x52

Long plastic base for Alpha trolley



REF.	NOTES	SIZE (cm) ↓ ↓ ↓
P066011U	with wheels ø 100 mm	91x52
P066031U	with rubber wheels ø 125 mm	91x52
P066061U	with wheels ø 125 mm	91x52
P166031U	with five ø 125 mm rubber wheels	91x52

Base extension for Alpha trolleys and for the bag supporting plastic plate of the Morgan Hotel Elegance trolleys



REF.	NOTES	SIZE (cm) ↓ ↓ ↓
P165000U	without castors	22x48
P065060U	with two wheels ø 125 mm and 2 blockings plugs	22x48

Supporting plastic plate for Alpha trolleys

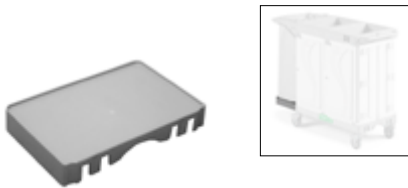

REF.	NOTES	SIZE (cm) ↓ ↓ ↓
P175000U		32x48x7

Reinforced vertical frame, 1 side with slides + 1 side for T-plugs, complete with screws and plugs

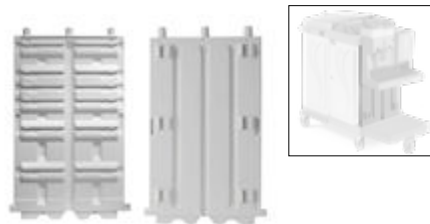

REF.	NOTES
P2039908E	

Reinforced vertical frame slides/slides, complete with screws and plugs

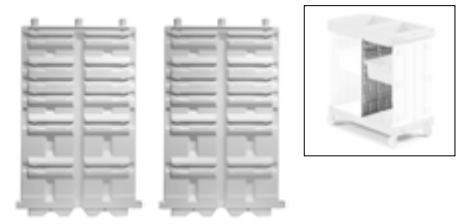

REF.	NOTES
P2039911E	

Quick connection kit Link-Up (4 pcs)

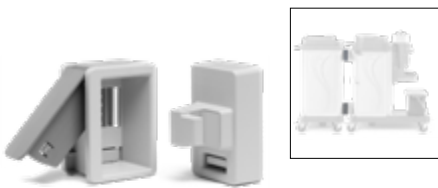

REF.	NOTES
0000SM00617	

Set of T-shaped closing plugs for vertical frames (6 pcs)



REF.	NOTES
0000SM00163	dark grey
0000SM00165	light grey

Fixed side wall with fixing pins

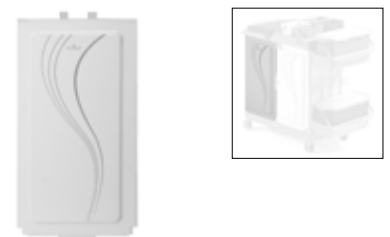

REF.	NOTES
P3059953E	

Right door with fixing pins



REF.	NOTES
P3059954E	

Left door with fixing pins



REF.	NOTES
P3059974E	

Right and left wing door set for Alpha trolleys



REF.	NOTES
P3059977E	



MORGAN HOTEL ELEGANCE

ALPHA HOTEL

EMOTION

KEEPHOTEL

TROLLEYS FOR LAUNDRY COLLECTION

SILVER

Central plastic basket (female-female version) with plugs



REF.	NOTES
P2199906U	internal sizes 31x48x8 cm

Central plastic basket (male-female version) with screws and plugs



REF.	NOTES
P2199907U	internal sizes 31x48x8 cm

Set with 2 central basket, screws and plugs



REF.	NOTES
P3199908U	

Central basket (female-female version) with divider and plugs



REF.	NOTES
P2199926U	with a grey cover
P2199926UT	with transparent cover
P2199936U	with 2 grey covers
P2199936UT	with 2 transparent covers

Central basket (male-female version) with divider and plugs



REF.	NOTES
P2199927U	with a grey cover
P2199927UT	with transparent cover
P2199937U	with 2 grey covers
P2199937UT	with 2 transparent covers

Set of 2 central baskets with dividers, screws and plugs



REF.	NOTES
P3199928U	with 2 grey covers
P3199938U	with 4 grey covers

Closing profile with push-grip for central basket and central bag holder complete with screws and plugs

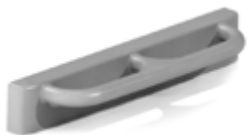

REF.	NOTES
P2909921U	

Folding 120l waste bag holder, with bag retaining hooks, 2 fixed dustpan hooks, 1 handle clip, 2 Uni-Move clips, screws and plugs



REF.	NOTES
P816113U	
P816115U	for trolleys with central frame

Set of plastic shelves (2 pcs)



REF.	NOTES	SIZE (cm)
P1229900U		↓ ↓ ↓ 21,5x37,5x1,5

Plastic Shelf 46,5x79 cm



REF.	NOTES
P2229911U	



MORGAN HOTEL ELEGANCE

ALPHA HOTEL

EMOTION

KEEPHOTEL

TROLLEYS FOR LAUNDRY
COLLECTION

SILVER

Accessories for Alpha Hotel trolleys

Side plastic basket



REF.	NOTES
P1191100U	internal sizes 22x49x11,5 cm

Bumper set for 120-litre bag holder
(no. 1 right bumper + no. 1 left bumper)



REF.	NOTES
0000SM00260	

Plastic cover for bag holder 120 L with
storage room, check-list holder and lock

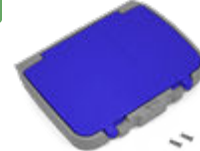

REF.	NOTES
P291920UA	
P291920UB	
P291920U	

Please, require also no. 2 shock absorbing pistons art. P190908U for a perfect soft closing

Shock absorbing piston for a soft closing
of the cover



REF.	NOTES
P190908U	



emotion

A new way to communicate through room service trolleys



YouTube



Emotion is Filmop line of trolleys for general and professional cleaning in hotels. Emotion trolleys are **handy, strong**, extremely modular and made of high quality polypropylene materials, from the base to the vertical frames, the shelves and all other accessories. Open or completely closed models are available to guarantee **the highest hygiene** and **the utmost security**. Moreover, thanks to their doors these trolleys always keep a clean and tidy look.

Next to their functionality, Emotion trolleys are characterized by their elegant, simple and pleasant design, enriched by a **new elegant graphics**.

Elegance and style match perfectly together with plainness and efficiency.

Thanks to its several components Emotion trolley can be fully accessorized and, consequently, it is ideal for any cleaning need; not only for the change of dirty clean linen, but also for room and bathroom cleaning, for waste collection and mini-bar refilling.

A very close and accurate research and planning have developed a line of trolleys that can be customized with images, special designs, pictures or brands, thus transforming, in a very completely original way, a simple service trolley into an advertising vehicle or into a trolley perfectly fitting the surrounding environment.

Some details about the Emotion line:



Base with 5 rubber wheels
Ø 125 mm to increase



Bag holder with bumpers.



Door with locking system
with removable key and with
ergonomic hand grip



Customizable design

Housekeeping trolleys



MORGANHOTEL ELEGANCE

ALPHA HOTEL

EMOTION

KEEPHOTEL

TROLLEYS FOR LAUNDRY
COLLECTION

SILVER

Open line

EMOTION 0105021 - with bag holder
+ small shelf



REF.	SIZE (cm) ↓ ↓ ↓
SE0105021AE00	110x64x142,5
Suggested for 6 to 8 rooms - Maximum pull-out shelf capacity 15 kg	

EMOTION 0301021 - with bag holder
+ big shelf



REF.	SIZE (cm) ↓ ↓ ↓
SE0301021AE00	154x64x103,5
Suggested for 8 to 10 rooms - Maximum pull-out shelf capacity 30 kg	

EMOTION 0401021 - with bag holder
+ small shelves



REF.	SIZE (cm) ↓ ↓ ↓
SE0401021AE00	154x64x103,5
Suggested for 8 to 10 rooms - Maximum pull-out shelf capacity 15 kg	

EMOTION 0304004 - with big shelf



REF.	SIZE (cm) ↓ ↓ ↓
SE0304004AE00	110x64x142,5
Advised for 10-12 room service - Maximum pull-out shelf capacity 30 kg	

EMOTION 0404021 - with small shelves



REF.	SIZE (cm) ↓ ↓ ↓
SE0404021AE00	110x64x142,5
Advised for 10-12 room service - Maximum pull-out shelf capacity 15 kg	

EMOTION 0305021 - with bag holder
+ big shelf



REF.	SIZE (cm) ↓ ↓ ↓
SE0305021AE00	154x64x142,5
Advised for 10-12 room service - Maximum pull-out shelf capacity 30 kg	

EMOTION 0505021 - with bag holder + big
and small shelf + drawers



REF.	SIZE (cm) ↓ ↓ ↓
SE0505021AE06	154x64x142,5
Advised for 10-12 room service - Maximum pull-out shelf capacity big 30 kg, small 15 kg	

EMOTION 0605021 - with bag holder
+ small shelves



REF.	SIZE (cm) ↓ ↓ ↓
SE0605021AE00	154x64x142,5
Advised for 10-12 room service - Maximum pull-out shelf capacity 15 kg	

EMOTION 0306021 - with 2 bag holders
+ big shelf



REF.	SIZE (cm) ↓ ↓ ↓
SE0306021AE00	197x64x142,5
Advised for 10-12 room service - Maximum pull-out shelf capacity 30 kg	

⚠ BAGS NOT INCLUDED

HOUSEKEEPING
TROLLEYS



MORGAN HOTEL ELEGANCE

ALPHA HOTEL

EMOTION

KEEPHOTEL

TROLLEYS FOR LAUNDRY
COLLECTION

SILVER

EMOTION 0506021 - with 2 bag holders
+ big shelf



REF.	SIZE (cm) ↓ ↓ ↓
SE0506021AE00	197x64x142,5
Advised for 10-12 room service - Maximum pull-out shelf capacity 30 kg	

EMOTION 0318021 - with bag holder
+ bathrobe holder + big shelf



REF.	SIZE (cm) ↓ ↓ ↓
SE0318021AE00	175x64x142,5
Advised for 10-12 room service - Maximum pull-out shelf capacity 30 kg	

Closed line

EMOTION 0000020 - with drawers

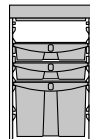

REF.	SIZE (cm) ↓ ↓ ↓
SE0000020AE01	65x64x103,5
Suggested for the mini bar refilling	

EMOTION 0104020 - with drawers

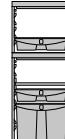

REF.	SIZE (cm) ↓ ↓ ↓
SE0104020AE01	81x64x142,5
Suggested for the mini bar refilling	

EMOTION 0105020 - with bag holder
+ small shelf

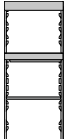

REF.	SIZE (cm) ↓ ↓ ↓
SE0105020AE00	110x64x142,5
Suggested for 6 to 8 rooms - Maximum pull-out shelf capacity 15 kg	

EMOTION 0106020 - with 2 bag holders
+ small shelf



REF.	SIZE (cm) ↓ ↓ ↓
SE0106020AE00	159x64x142,5
Suggested for 6 to 8 rooms - Maximum pull-out shelf capacity 15 kg	

EMOTION 0300020 - with big shelf



REF.	SIZE (cm) ↓ ↓ ↓
SE0300020AE00	110x64x103,5
Suggested for 8 to 10 rooms - Maximum pull-out shelf capacity 30 kg	

EMOTION 0301020 - with bag holder
+ big shelf



REF.	SIZE (cm) ↓ ↓ ↓
SE0301020AE00	154x64x103,5
Suggested for 8 to 10 rooms - Maximum pull-out shelf capacity 30 kg	

⚠ BAGS NOT INCLUDED

Housekeeping trolleys



MORGAN HOTEL ELEGANCE

ALPHA HOTEL

EMOTION

KEEPHOTEL

TROLLEYS FOR LAUNDRY
COLLECTION

SILVER

EMOTION 0304020 - with big shelf

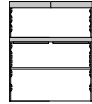

REF.	SIZE (cm) ↓ ↓ ↓
SE0304020AE00	110x64x142,5

Advised for 10-12 room service - Maximum pull-out shelf capacity 30 kg

EMOTION 0305020 - with bag holder + big shelf



REF.	SIZE (cm) ↓ ↓ ↓
SE0305020AE00	154x64x142,5

Advised for 10-12 room service - Maximum pull-out shelf capacity 30 kg

EMOTION 0306020 - with 2 bag holders + big shelf

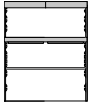

REF.	SIZE (cm) ↓ ↓ ↓
SE0306020AE00	197x64x142,5

Advised for 10-12 room service - Maximum pull-out shelf capacity 30 kg

EMOTION 0317020 - with bag holder + holder for upright vacuum cleaner + big shelf

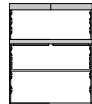

REF.	SIZE (cm) ↓ ↓ ↓
SE0317020AE00	175x64x142,5

Advised for 10-12 room service - Maximum pull-out shelf capacity 30 kg

EMOTION 0316020 - with buckets + big shelf



REF.	SIZE (cm) ↓ ↓ ↓
SE0316020AE00	138x64x142,5

Advised for 10-12 room service - Maximum pull-out shelf capacity 30 kg

BAGS NOT INCLUDED



MORGANHOTEL ELEGANCE

ALPHA HOTEL

EMOTION

KEEPHOTEL

TROLLEYS FOR LAUNDRY
COLLECTION

SILVER

Components for Emotion trolleys

Short base with 5 wheels without bumpers



REF.	NOTES
P159061Q	with wheels ø 125 mm
P159081Q	with 125mm ø wheels, 2 lockable

Short base with 5 wheels and bumpers ø 200 mm



REF.	NOTES
P159131Q	with rubber wheels ø 125 mm
P159141Q	with rubber wheels ø 125 mm, 2 with brake
P159261Q	with wheels ø 125 mm with tread 35 mm

Long base with 5 wheels without bumpers



REF.	NOTES
P166061Q	with wheels ø 125 mm
P166081Q	with wheels ø 125 mm, 2 with brake

Long base with 5 wheels and bumpers ø 200 mm



REF.	NOTES
P166131Q	with rubber wheels ø 125 mm
P166141Q	with rubber wheels ø 125 mm, 2 with brake
P166261Q	with wheels ø 125 mm with tread 35 mm

Long base with 4 wheels without bumpers



REF.	NOTES
P066251Q	with rubber wheels ø 150 mm (2 fixed + 2 pirouetting)
P066231Q	with rubber wheels ø 200 mm (2 fixed + 2 pirouetting)
P066281Q	with wheels ø 200 mm (2 fixed + 2 pirouetting)

Supporting plastic plate with 2 wheels

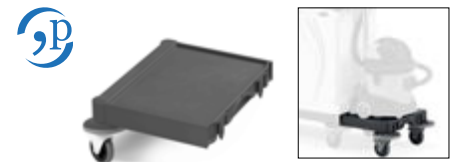

REF.	NOTES
P515060Q	with wheels ø 125 mm without bumpers
P515130Q	with rubber wheels ø 125 mm and bumpers ø 200 mm

Supporting plastic plate with 1 wheel

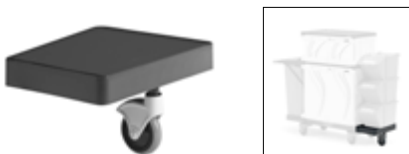

REF.	NOTES
P075130Q	with rubber wheel ø 125 mm
P075060Q	with wheel ø 125 mm

Base extension for Emotion trolleys

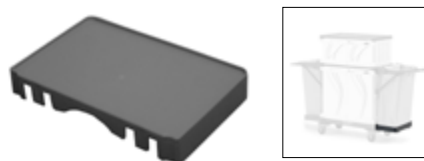

REF.	NOTES	SIZE (cm)
P175000Q		48x32x7

Supporting plate fitting the base of Emotion trolleys

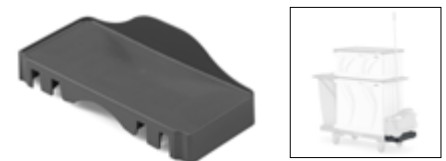

REF.	NOTES	SIZE (cm)
P165000Q		48x22x15

Big vertical frame, 1 side for T-plugs + 1 side with slides, complete with screws

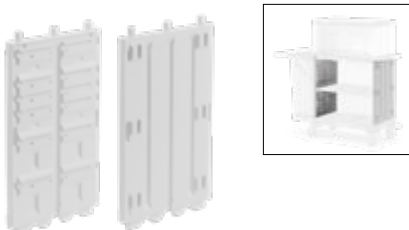

REF.	NOTES
P2038805E	

Big vertical frame, 2 sides with slides, complete with screws

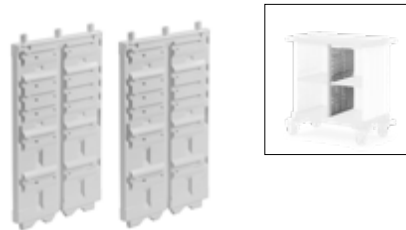

REF.	NOTES
P3038804E	

Small vertical frame, 1 smooth side + 1 side with slides

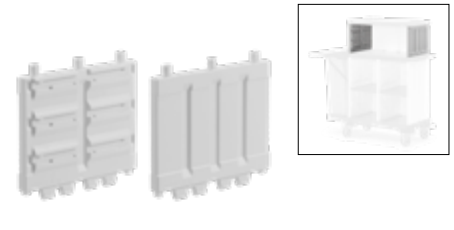

REF.	NOTES
P2038806E	

Housekeeping trolleys



MORGANHOTEL ELEGANCE

ALPHA HOTEL

EMOTION

KEEPHOTEL

TROLLEYS FOR LAUNDRY
COLLECTION

SILVER

Small vertical frame, 2 sides with slides

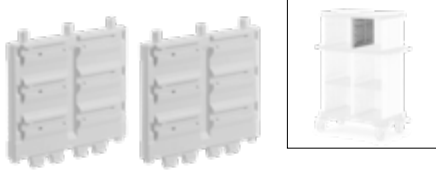

REF. **P203880E**

NOTES

Small vertical frame, 1 side with slides + 1 side for T-plugs

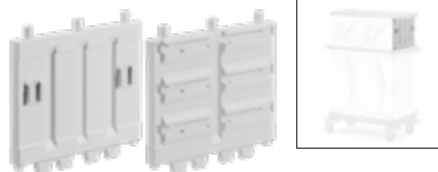

REF. **P203880E**

NOTES

Set of T-shaped closing plugs for vertical frames (6 pcs)



REF. **000SM00163** dark grey
000SM00165 light grey

NOTES

Small fixed side wall



REF. **P194880E**

NOTES

Big fixed side wall



REF. **P191880E**

NOTES

Side-walls blocking device

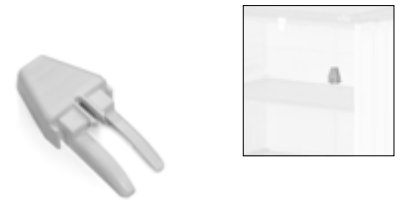

REF. **P1908839E**

NOTES

Big right door with lock and assembling kit



REF. **P392880E**

NOTES

Big left door with assembling kit



REF. **P393880E**

NOTES

Small right door with lock and assembling kit



REF. **P395880E**

NOTES

Small left door with assembling kit



REF. **P396880E**

NOTES

Long smooth fixed shelf

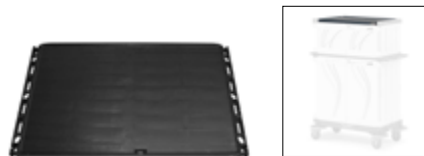

REF. **P222880Q**

NOTES

Long smooth fixed shelf with central tray support



REF. **P322880Q**

NOTES



MORGAN HOTEL ELEGANCE

ALPHA HOTEL

EMOTION

KEEPHOTEL

TROLLEYS FOR LAUNDRY COLLECTION

SILVER

Big fixed shelf with seat for vertical frame

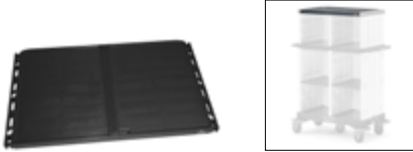

REF. NOTES
P2328801Q

Long fixed shelf with seat for vertical frame and central tray support



REF. NOTES
P3228801QU

Small fixed shelf (female-female version)



REF. NOTES
P1228802Q

Small fixed shelf (male-female version)

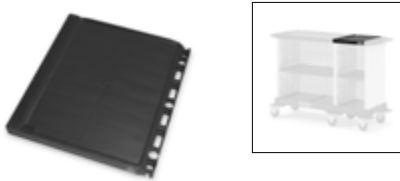

REF. NOTES
P2228803Q

Closing profile



REF. NOTES
P2908820Q right for Emotion trolley without door
P2908821Q left for Emotion trolleys without door
P2908822Q right for Emotion trolleys with door
P2908823Q left for Emotion trolleys with door

Closing profile with push-grip



REF. NOTES
P3908833Q right for Emotion trolley without door
P3908834Q left for Emotion trolleys without door
P3908835Q right for Emotion trolleys with door
P3908836Q left for Emotion trolleys with door

Foldable bag holder 120 lt with bumpers

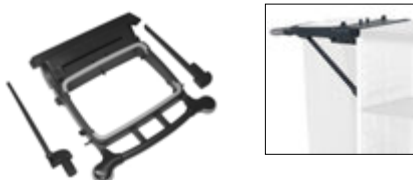

REF. NOTES
P8268802Q right for Emotion trolley without door
P8268803Q left for Emotion trolleys without door
P8268800Q right for Emotion trolleys with door
P8268801Q left for Emotion trolleys with door

Foldable bag holder 120 lt without bumpers

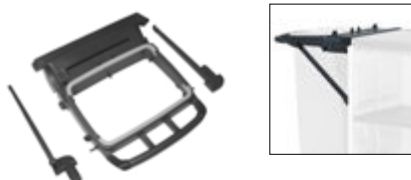

REF. NOTES
P8168802Q right for Emotion trolley without door
P8168803Q left for Emotion trolleys without door
P8168800Q right for Emotion trolleys with door
P8168801Q left for Emotion trolleys with door

Bumper set for 120-litre bag holder (no. 1 right bumper + no. 1 left bumper)

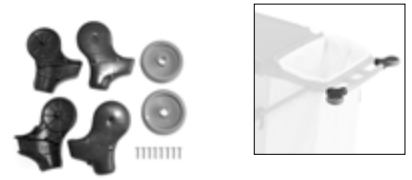

REF. NOTES
000SM00260

Small pull-out shelf

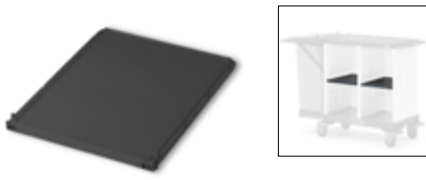

REF. NOTES SIZE (cm)
P2229910Q 37,5x46,5

Long pull-out shelf

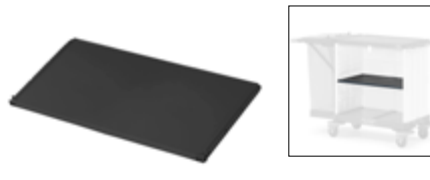

REF. NOTES SIZE (cm)
P2229911Q 79x46,5

Plastic sliding tray with slide out limiter and key

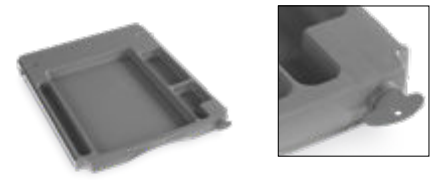

REF. NOTES
P3229915U

Housekeeping trolleys



MORGAN HOTEL ELEGANCE

ALPHA HOTEL

EMOTION

KEEPHOTEL

TROLLEYS FOR LAUNDRY COLLECTION

SILVER

Plastic sliding drawer without locking key



REF.	NOTES	CAPACITY (L)	SIZE (cm) ↓ ↓ ↓
P1229909U	internal dimensions 41x34x9,5 cm	10	46,5x37,5x11
P1229906U	internal dimensions 40,5x34x16 cm	22	46,5x37,5x17
P1229907U	internal dimensions 40x34x33,5 cm	40	46,5x37,5x35

Plastic sliding drawer with locking key



REF.	NOTES	CAPACITY (L)	SIZE (cm) ↓ ↓ ↓
P2229909U	internal dimensions 41x34x9,5 cm	10	46,5x37,5x11
P2229906A	internal dimensions 40,5x34x16 cm	22	46,5x37,5x17
P2229906B	internal dimensions 40,5x34x16 cm	22	46,5x37,5x17
P2229906U	internal dimensions 40,5x34x16 cm	22	46,5x37,5x17
P2229907U	internal dimensions 40x34x33,5 cm	40	46,5x37,5x35

Rilsan coated support for upright vacuum cleaner fitting vertical frames



REF.	NOTES
R2180085	

Bathrobe and/or towel holder kit



REF.	NOTES
Q1400123E	Recommended with bag supporting plastic plate

Accessories for Emotion trolleys

Divider for plastic bag holder 120 L



REF.	NOTES
P206020U	2x60 L
P206030U	1x40 L + 1x80 L
P206040U	3x40 L

Plastic divider with square shaped insert for bag holder 120 L



REF.	NOTES
P306020U	2x60 L and 20 L square shaped insert
P406020U	2x60 L and two 20 L square shaped inserts

For Alpha, Emotion range bag holders and bag holder code P906010U, Morgan range

Square plastic support 20 L for the divider of bag holder 120 L



REF.	NOTES
P1909957U	For Alpha, Emotion range bag holders and bag holder code P906010U, Morgan range - Use recommended with net bags, code 0000AT0210



MORGANHOTEL ELEGANCE

ALPHA HOTEL

EMOTION

KEEPHOTEL

TROLLEYS FOR LAUNDRY COLLECTION

SILVER

Plastic cover for bag holder 120 L with check-list holder

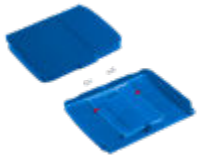

REF.	NOTES
P291919A	
P291919B	
P291919T	

Please, require also no. 2 shock absorbing pistons art. P190908U for a perfect soft closing

Plastic cover for bag holder 120 L with storage room, check-list holder and lock

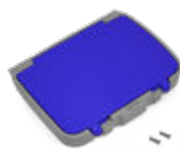

REF.	NOTES
P291920UA	
P291920UB	
P291920U	

Please, require also no. 2 shock absorbing pistons art. P190908U for a perfect soft closing

Tablet holder for mounting on Emotion vertical frame



REF.	NOTES
0000SM00402	

For tablet sizes 7 to 10.1 inches (20 to 31 cm)

Plastified bag with bottom grip



REF.	NOTES	CAPACITY (L)	SIZE (cm) ↓ ↓ ↓
0000AT0120E		120	28x42x98

Plastic pocket bags to attach to the vertical frames



REF.	NOTES
Q0400073Q	

Plastic divider for drawer 10 L



REF.	NOTES
0000SM00227D	9 compartments
0000SM00228D	12 compartments

Set of 1 big divider 39 cm + 1 medium divider 32 cm for plastic sliding drawer 22 L

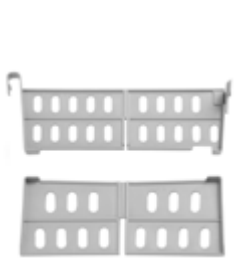

REF.	NOTES
0000SM00213U	

Set of 1 big divider 39 cm + 3 small dividers 16 cm for plastic sliding drawer 22 L



REF.	NOTES
0000SM00214U	

Laundry collection trolley with bag 200 L with zip and closure



REF.	NOTES	SIZE (cm) ↓ ↓ ↓
0000HP3110Q5		101,5x64,5x92

Housekeeping trolleys



MORGAN HOTEL ELEGANCE

ALPHA HOTEL

EMOTION

KEEPHOTEL

TROLLEYS FOR LAUNDRY COLLECTION

SILVER

Rilsan coated coupling device to connect the Emotion trolley to a laundry trolley



REF.	NOTES
R1180080	

Side plastic basket



REF.	NOTES
P1191100U	internal sizes 22x49x11,5 cm

Grey waste collection bin 10 L with handle



REF.	NOTES	CAPACITY (L)	SIZE (cm) ↓ ↓ ↓
8168/1U		10	13,5x21x36

UNILAV SIDE GRIP - flat mop with 650ml bottle and holder with strap tapes



REF.	NOTES
0000TD0151A	with plate 40 cm
0000TD0151U	with plate 40 cm
0000TD0161A	with plate 60 cm



KeepHotel: the trolley for hotels

KeepHotel is a service trolley designed to make cleaning and preparing rooms in hotels, bed & breakfasts and holiday resorts **easier, faster** and **more discreet**.

Functional and refined with attention paid to the smallest of details, KeepHotel is the **ideal solution for managing accommodations facilities**.

- Thanks to the **plain and essential style** it can be perfectly integrated into the environment in which it is used.
- Its **compact size** allows the ease of movement and access.
- It is designed to offer **maximum practicality** in facilitating various cleaning and tidying operations.
- Spacious and equipped with **useful compartments and movable dividers** to better organize all the equipment.
- Hygienic thanks to the **internal lining that can be easily removed** to facilitate cleaning.

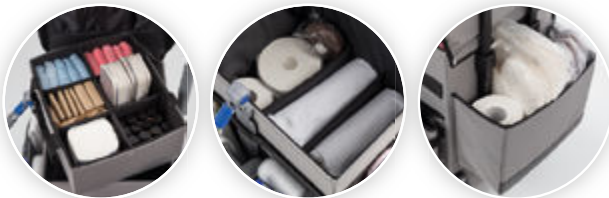

KEEPHOTEL - trolley made of plastic coated material with wheels ø 90 mm



REF.	NOTES	SIZE (cm) ↓ ↓ ↓
9590		67x43x100

Suggested for 2 to 3 rooms

KEEPHOTEL - trolley made of plastic coated material with axial wheels ø 200 mm



REF.	NOTES	SIZE (cm) ↓ ↓ ↓
9591		67x48x108

Suggested for 2 to 3 rooms

KEEPHOTEL - trolley made of plastic coated material with Rilsan coated frame and wheels ø 300 mm



REF.	NOTES	SIZE (cm) ↓ ↓ ↓
9592		77x50x114

Suggested for 2 to 3 rooms

KEEPHOTEL - trolley made of plastic coated material with Rilsan coated frame and 4 wheels ø 80 mm, 2 with brake



REF.	NOTES	SIZE (cm) ↓ ↓ ↓
9593		67x43x97,5

Suggested for 2 to 3 rooms



MORGANHOTEL ELEGANCE

ALPHA HOTEL

EMOTION

KEEPHOTEL

TROLLEYS FOR LAUNDRY COLLECTION

SILVER

"X" trolley for laundry collection

Thanks to the **foldable X-trolley** it is easier to handle the linen management in the accomodation facilities, assuring the **maximum confort and practicality**:

- The plastic coated bag is equipped with zip to empty the content easily
- The metal structure assures the maximum shock-proof resistance
- The pivoting wheels help to handle the trolley
- Foldable to reduce the overall dimensions, suitable also for the smallest closets
- Available with bag 200L or two bags 100L for the laundry separate collection



"X" trolley for laundry collection

Foldable laundry trolley with plastic coated bag and pirouetting wheels Ø 80 mm



Chromed X-trolley for laundry collection, plastified bag and pirouetting wheels ø 80 mm



REF.	NOTES	SIZE (cm) ↓ ↓ ↓
3105	with bag 200L	88,5x54x97
3106	with 2 bags 100L	88,5x54x97

Folded trolley dimensions cm 88,5x20x108 h

REF.	NOTES	SIZE (cm) ↓ ↓ ↓
8043	with 4 hooks and bag 150 L	62x60x103
8044	with 6 hooks and bag 180 L	62x70x103



MORGAN HOTEL ELEGANCE

ALPHA HOTEL

EMOTION

KEEPHOTEL

TROLLEYS FOR LAUNDRY COLLECTION

SILVER

Modular laundry trolleys

Rilsan coated trolley for laundry collection with push-bar, pedal, cover, pistons, elastic and ø 80 mm pirouetting wheels



REF.	CAPACITY (L)	SIZE (cm) ↓ ↓ ↓
R9276	70	48,2x48x97
R9277	2X70	48,2x89x97
R9278	3X70	114,5x48,2x95

Rilsan coated trolley for laundry collection with pedal, cover, pistons, elastic and ø 80 mm pirouetting wheels



REF.	CAPACITY (L)	SIZE (cm) ↓ ↓ ↓
R9176	70	48,2x39,2x95
R9177	2x70	48,2x74,5x95
R9178	3x70	48,2x110x95
R9179	4x70	48,2x146x95

Rilsan coated trolley for laundry collection with push-bar, cover, pistons, elastic and ø 80 mm pirouetting wheels



REF.	CAPACITY (L)	SIZE (cm) ↓ ↓ ↓
R9266	70	48,2x48x97
R9267	2X70	48,2x89x97
R9268	3X70	48,2x124,5x97

Rilsan coated trolley for laundry collection with cover, pistons, elastic and ø 80 mm pirouetting wheels



REF.	CAPACITY (L)	SIZE (cm) ↓ ↓ ↓
R9166	70	48,2x39,2x95
R9167	2X70	48,2x74,5x95
R9168	3X70	48,2x110x95
R9169	4X70	48,2x146x95

Rilsan coated trolley for laundry collection with push-grip, elastic and pirouetting wheels ø 80 mm



REF.	NOTES	CAPACITY (L)	SIZE (cm) ↓ ↓ ↓
R9256		70	48,2x48x97
R9257		2X70	48,2x89x97

Rilsan coated trolley for laundry collection complete with elastic and pirouetting wheels ø 80 mm



REF.	NOTES	CAPACITY (L)	SIZE (cm) ↓ ↓ ↓
R9156		70	48,2x39,2x95
R9157		2X70	48,2x74,5x95
R9158		3X70	48,2x110x95
R9159		4X70	48,2x146x95



MORGANHOTEL ELEGANCE

ALPHA HOTEL

EMOTION

KEEPHOTEL

TROLLEYS FOR LAUNDRY COLLECTION

SILVER

Components for trolleys for laundry collection

Plastified bag with front opening for foldable X-trolley for laundry collection



REF.	NOTES	CAPACITY (L)
Q0400131E		200
Q0400132E		100

Kit wheels and bumpers for laundry collection trolleys art. 3105-3106



REF.	NOTES
0000SM00312	

Supporting plastic plate for laundry trolleys art. R9176, R9177, R9178 and R9179

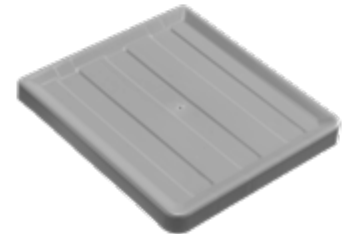

REF.	NOTES
P114021U	

Plastic pedal for laundry trolleys art. R9176, R9177, R9178 and R9179



REF.	NOTES
P190928U	

Stainless steel back rod connecting pedal/cover Ø 5,8 mm, lenght 76 cm for laundry trolleys art. R9176, R9177, R9178 e R9179



REF.	NOTES
I1900011	

Plastic plug to fix back rod connecting pedal/cover for laundry trolleys art. R9176, R9177, R9178 and R9179



REF.	NOTES
P190927U	

Double fixing device with snap closure for laundry trolleys art. R9176, R9177, R9178 and R9179



REF.	NOTES
8229U	

Plastic cover for laundry trolleys art. R9176, R9177, R9178 and R9179



REF.	NOTES
P290929A	
P290929B	
P290929C	
P290929F	

Bag fixing elastic



REF.	NOTES
8054	for trolleys art.8045,8070, 8075, 8076, 8077, 8077/1, R8377, 8040 and 8440
8054/1	for Trend and laundry trolleys

Pistons kit for soft-close cover on laundry trolleys



REF.	NOTES
0000SM00640	



MORGAN HOTEL ELEGANCE

ALPHA HOTEL

EMOTION

KEEPHOTEL

TROLLEYS FOR LAUNDRY COLLECTION

SILVER

Silver trolleys are practical and handy service trolleys, ideal for hotels, restaurants, company canteens and fast-food chains.

Silver is also available in the **panelled version**:



- **Higher capacity and safer:** thanks to the plastic closing walls storage possibilities and stability during transportation are surely improved, thus offering an even more efficient service
- **Smarter and more versatile:** its neat and modern design with two colour options makes it suitable for all environments
- **More hygienic and ergonomic:** thanks to its smooth surfaces with rounded up corners it can be easily cleaned and thanks to its ergonomic push-bars it can be easily handled
- **Stronger:** Silver is handy and very strong as it is manufactured with aluminium vertical frames and plastic shelves/walls (up to 50 kg per each shelf)
- **More silent:** it is available also with rubber wheels \varnothing 125 mm, highly sliding and silent, with bumpers



Versions closed by plastic panels, available in two colours



Available also with rubber wheels \varnothing 125 mm and with shock-absorbing bumpers



Ergonomic, rounded shape and plastic push-bar



Silver trolleys

SILVER 1200 - service trolley with aluminium vertical frames, 2 shelves and wheels \varnothing 100x28 mm



SILVER 1300 - service trolley with aluminium vertical frames

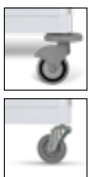

REF.	NOTES	SIZE (cm)
		↓ ↓ ↓
0000SP1200D		111x50x103
0000SP1200E		111x50x103

Maximum load capacity of each shelf: 50 kg

REF.	NOTES	SIZE (cm)
		↓ ↓ ↓
0000SP1300D	\varnothing 100x28 mm wheels	111x50x103
0000SP1300E	\varnothing 100x28 mm wheels	111x50x103
0000SP1300D16	\varnothing 125 mm rubber wheels and \varnothing 130 mm bumpers	111x58x104
0000SP1300E16	\varnothing 125 mm rubber wheels and \varnothing 130 mm bumpers	111x58x104

Max load capacity 50 kg/shelf - Available height between the individual shelves about 32 cm

Housekeeping trolleys



MORGANHOTEL ELEGANCE

ALPHA HOTEL

EMOTION

KEEPHOTEL

TROLLEYS FOR LAUNDRY
COLLECTION

SILVER

SILVER 1310 - service trolley with plastic vertical frames, 3 shelves and wheels ø 100x28 mm



SILVER 1301 - trolley with aluminium vertical frames, 3 shelves and closing walls



REF.	NOTES	SIZE (cm) ↓ ↓ ↓
0000SP1310D		111x50x103
0000SP1310E		111x50x103

Max load capacity 50 kg/shelf - Available height between the individual shelves about 32 cm

REF.	NOTES	SIZE (cm) ↓ ↓ ↓
0000SP1301D	ø 100x28 mm wheels	111x50x103
0000SP1301E	ø 100x28 mm wheels	111x50x103
0000SP1301D16	ø 125 mm rubber wheels and ø 130 mm bumpers	111x58x107
0000SP1301E16	ø 125 mm rubber wheels and ø 130 mm bumpers	111x58x107

Max load capacity 50 kg/shelf - Available height between the individual shelves about 32 cm

Components for Silver trolleys

Plastic base for Silver trolley



REF.	NOTES	SIZE (cm) ↓ ↓ ↓
P104001D		89x49
P104001E		89x49

Central plastic shelf for Silver trolley



REF.	NOTES	SIZE (cm) ↓ ↓ ↓
P104002D		89x49
P104002E		89x49

Top plastic shelf for Silver trolley



REF.	NOTES	SIZE (cm) ↓ ↓ ↓
P104003D		89x49
P104003E		89x49

Kit for closing the lower part of Silver trolleys

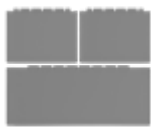

REF.	NOTES	
0000SM00244D		
0000SM00244E		

Kit for closing the upper part of Silver trolleys



REF.	NOTES	
0000SM00245D		
0000SM00245E		

Plastic push-bar for Silver trolley



REF.	NOTES
P179080U	

Plastic vertical frame 29,6 cm for Silver trolleys with 3 shelves



REF.	NOTES
PA50028N	

Aluminium vertical frame for Silver trolley



REF.	NOTES	SIZE (cm) ↓ ↓ ↓
0000SM00242	set 4 pcs vertical frames for Silver with three shelves	29,6
0000SM00225	set 2 pcs vertical frames for Silver with two shelves	66

Plastic bin 25 L for Silver trolley



REF.	NOTES
8269/1	

Accessories for Silver trolleys

HOUSEKEEPING
TROLLEYS

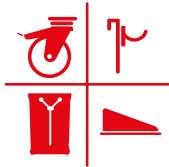

Complements and accessories

Carry baskets

Paper holders for
paper rolls

Quivers

Holder for gloves and
disinfectant solution

Door stoppers

Hoses for bucket filling

Note boards

Tool holder and hooks

Bags

Wheels

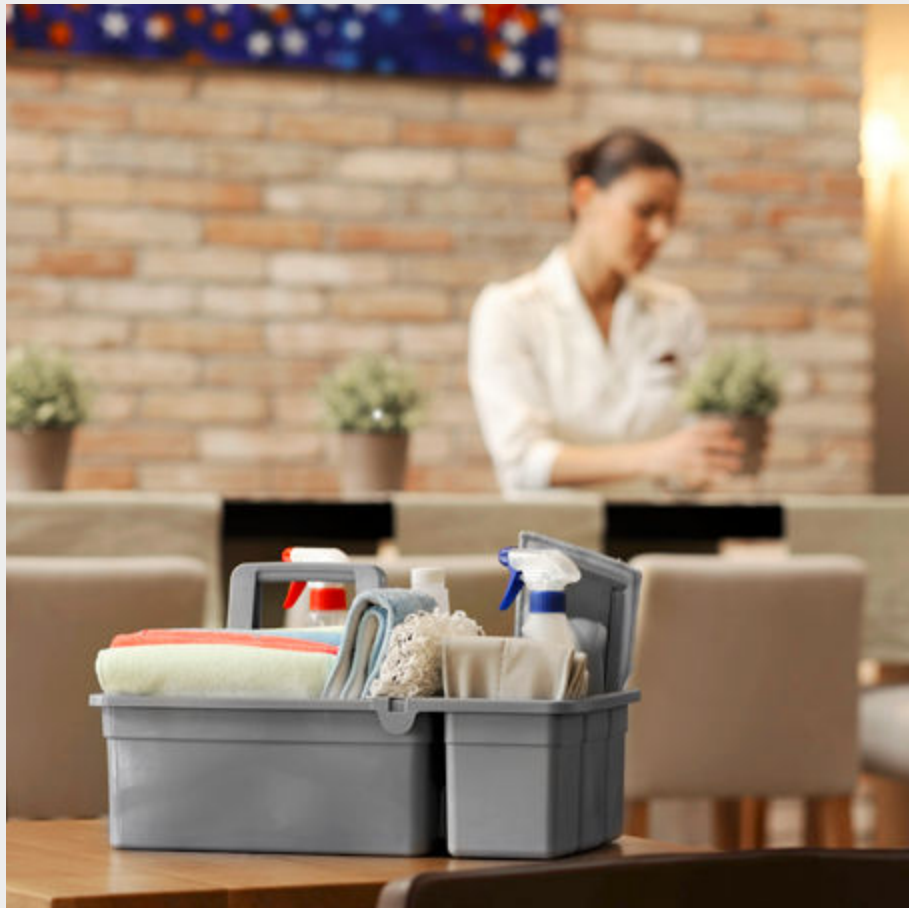



- CARRY BASKETS**
- PAPER HOLDERS FOR PAPER ROLLS
- QUIVERS
- HOLDER FOR GLOVES AND DISINFECTANT SOLUTION
- DOOR STOPPERS
- HOSES FOR BUCKET FILLING
- NOTE BOARDS
- TOOL HOLDER AND HOOKS
- BAGS
- WHEELS

■ Baskets with dividers

Plastic basket complete with 3 dividers

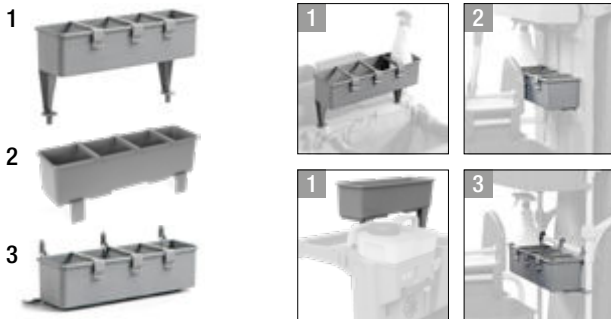

REF.	NOTES
P2191101U	1. suitable for the closing profile and bag holder 120 L of Alpha trolleys
P2191103U	1. for mounting on Alpha trolley finishing trim and 120L bag holder - with long fittings
P2191102U	2. suitable for the vertical frames of Alpha trolleys
P219007U	3. suitable for the vertical frame of Morgan trolley art. 0000MP3080A

■ Carry baskets with grip

Plastic carry basket with special shaped bottle holder, 2 compartments and fixed grip



REF.	NOTES	SIZE (cm)
3690U		↓ ↓ ↓ 33,5x28,3x27

Plastic carry basket with special shaped bottle holder, 2 compartments and grip



REF.	NOTES	SIZE (cm)
3691U		↓ ↓ ↓ 32,5x25x31

Plastic carry basket complete with 3 dividers and grip



REF.	NOTES	SIZE (cm)
3669U		↓ ↓ ↓ 32,5x25x31

Plastic carry basket with 3 compartments and grip



REF.	NOTES	SIZE (cm)
3635U		↓ ↓ ↓ 40x29x17

- CARRY BASKETS
- PAPER HOLDERS FOR PAPER ROLLS
- QUIVERS
- HOLDER FOR GLOVES AND DISINFECTANT SOLUTION
- DOOR STOPPERS
- HOSES FOR BUCKET FILLING
- NOTE BOARDS
- TOOL HOLDER AND HOOKS
- BAGS
- WHEELS

Accessories for carry baskets

Side plastic basket with 3 compartments fitting basket art. 3690U



REF.	NOTES	SIZE (cm) ↓ ↓ ↓
60405U		17x28,3x14

Plastic bottle holder with 3 shaped holes for baskets art. 3691U and 3690U



REF.	NOTES	SIZE (cm) ↓ ↓ ↓
60404U		12,2x32x4

Rilsan coated holder for carry basket art. 3690U



REF.	NOTES
R2240040	fitting Morgan Hotel trolleys

Divider for plastic basket art. 3669U



REF.	NOTES
P1909940U	

Rilsan coated holder for carry basket art. 3635U



REF.	NOTES
R2240030	fitting Morgan Hotel trolleys

Carry baskets with support

Plastic carry basket



REF.	NOTES	SIZE (cm) ↓ ↓ ↓
60402A		32x13x14

Plastic support for basket

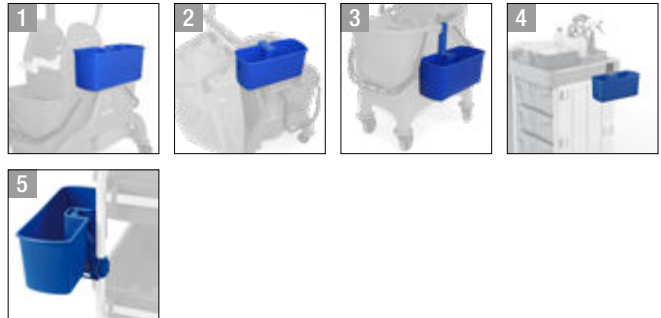
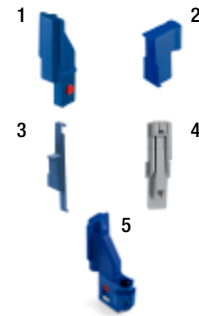

REF.	NOTES
P290800A	1. for Orion-Fred trolleys frame
P179002A	2. for bag holder art. P206002A of Vega trolley
P179001A	3. for Maxi Jolly single bucket
P1901113U	4. for vertical frame of Alpha trolleys
0000SM00126	5. for vertical frames ø 22 mm



CARRY BASKETS

PAPER HOLDERS FOR PAPER ROLLS

QUIVERS

HOLDER FOR GLOVES AND DISINFECTANT SOLUTION

DOOR STOPPERS

HOSES FOR BUCKET FILLING

NOTE BOARDS

TOOL HOLDER AND HOOKS

BAGS

WHEELS

Vertical paper holder

Set of vertical paper holder for Morgan trolleys



REF.

NOTES

P225005U

Paper holder with cover

Set of plastic paper holder with cover complete with 3 hooks



REF.

NOTES

P225004U

Rilsan coated support for paper holder complete with hooks and closing profile, fitting Alpha trolleys



REF.

NOTES

0000SM00643

Plastic paper holder

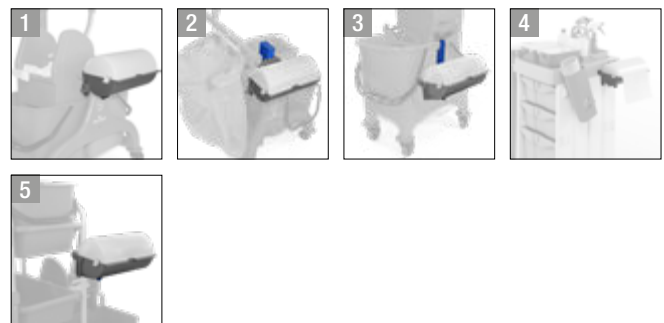
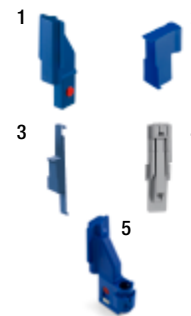

REF.

NOTES

P290800A

1. for Orion-Fred trolleys frame

P179002A

2. for bag holder art. P206002A of Vega trolley

P179001A

3. for Maxi Jolly single bucket

P190113U

4. for vertical frame of Alpha trolleys

0000SM00126

5. for vertical frames ø 22 mm

CARRY BASKETS

PAPER HOLDERS FOR PAPER ROLLS

QUIVERS

HOLDER FOR GLOVES AND DISINFECTANT SOLUTION

DOOR STOPPERS

HOSES FOR BUCKET FILLING

NOTE BOARDS

TOOL HOLDER AND HOOKS

BAGS

WHEELS

Plastic quivers

Plastic quiver for polybags



REF.	NOTES
P120007A	

Plastic quiver for window squeegees, washers, scrapers



REF.	NOTES
P120008A	it can be applied to the holder code P120007A

Plastic support for holder code P120007A

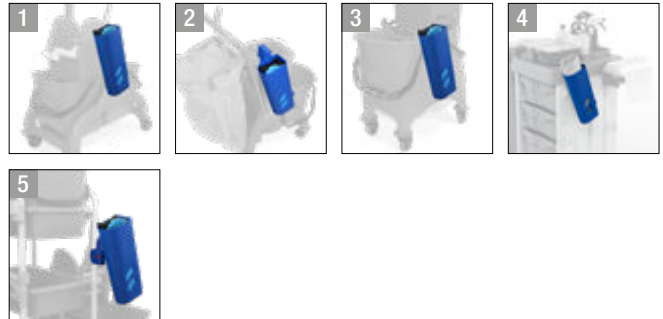
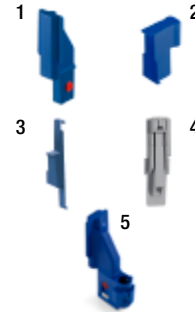

REF.	NOTES
P290800A	1. for Orion-Fred trolleys frame
P179002A	2. for bag holder art. P206002A of Vega trolley
P179001A	3. for Maxi Jolly single bucket
P1901113U	4. for vertical frame of Alpha trolleys
0000SM00126	5. for vertical frames ø 22 mm



CARRY BASKETS

PAPER HOLDERS FOR PAPER ROLLS

QUIVERS

HOLDER FOR GLOVES AND DISINFECTANT SOLUTION

DOOR STOPPERS

HOSES FOR BUCKET FILLING

NOTE BOARDS

TOOL HOLDER AND HOOKS

BAGS

WHEELS

Steel holder for gloves and disinfectant

Holder for gloves and disinfectant solution

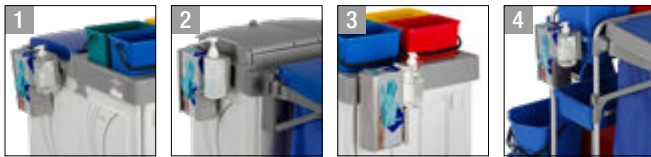

REF.	NOTES	SIZE (cm) ↓ ↓ ↓
I1050073	1. fitting Alpha bag holder 150 L 2. fitting Alpha central frame 3. fitting Alpha closing profile thanks to the long holder P1909959U	10x22x25
I1052073	4. fitting Morgan central baskets	11x22x25

Holder for disinfectant solution with support base

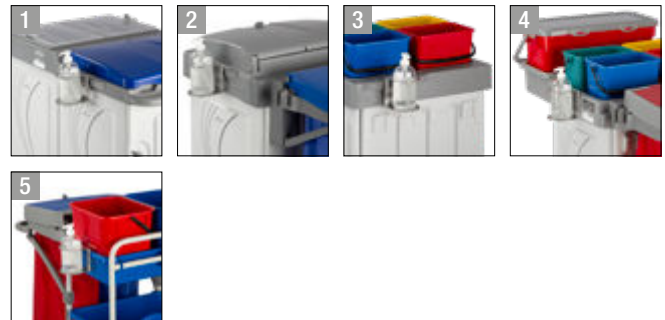

REF.	NOTES	SIZE (cm) ↓ ↓ ↓
I1050074	1. fitting Alpha bag holder 150 L 2. fitting Alpha central frame 3. fitting Alpha closing profile thanks to the long holder P1909959U	11,5x10x9,5
I1051074	4. fitting Alpha central upper baskets	13,5x10x9,5
I1052074	5. fitting Morgan central baskets	12,5x10x9,5

Holder for disinfectant solution without support base

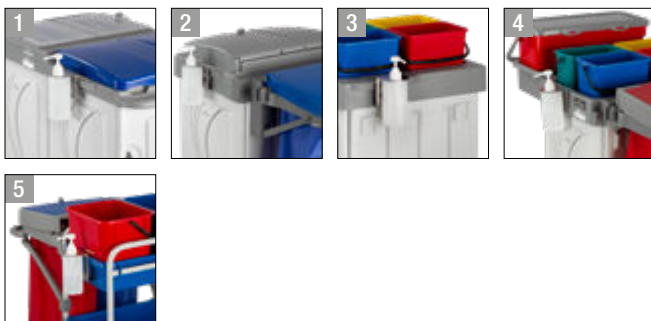

REF.	NOTES	SIZE (cm) ↓ ↓ ↓
I1050075	1. fitting Alpha bag holder 150 L 2. fitting Alpha central frame 3. fitting Alpha closing profile thanks to the long holder P1909959U	9x9x10
I1051075	4. fitting Alpha central upper baskets	13,5x9x10
I1052075	5. fitting Morgan central baskets	11x9x10

Gloves holder

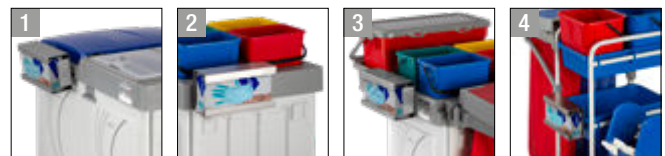
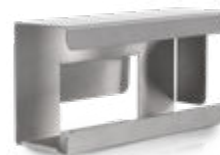

REF.	NOTES	SIZE (cm) ↓ ↓ ↓
I1050076	1. fitting Alpha bag holder 150 L 2. fitting Alpha closing profile thanks to the long holder P1909959U	10x25x14
I1051076	3. fitting Alpha central upper baskets	12x25x14
I1052076	4. fitting Morgan central baskets	11x25x14

CARRY BASKETS

PAPER HOLDERS FOR PAPER ROLLS

QUIVERS

HOLDER FOR GLOVES AND DISINFECTANT SOLUTION

DOOR STOPPERS

HOSES FOR BUCKET FILLING

NOTE BOARDS

TOOL HOLDER AND HOOKS

BAGS

WHEELS

Universal door stoppers

Door stopper made of plastic and rubber



REF.	NOTES	SIZE (cm) ↓ ↓ ↓
P130001Q		15x7,9x5

Door stopper made of plastic and rubber with handle 87 cm



REF.	NOTES	SIZE (cm) ↓ ↓ ↓
P230001Q		15,7x7,9x90

Hoses

Hose for bucket filling 110 cm



REF.	NOTES
P190010E	

Hose for bucket filling 150 cm



REF.	NOTES
P190020U	

Universal hose connection fitting all types of taps

Boards

Plastic board

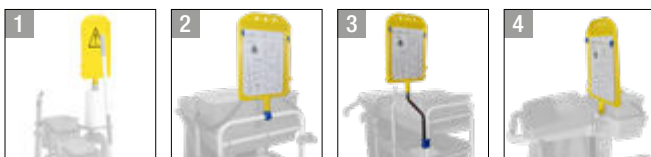
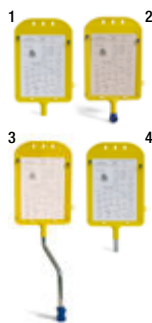

REF.	NOTES
P299001C	1. suitable for vertical paper holder art. P225001A
0000PA0101C	2. suitable for tubes ø 22 mm
0000PA0104C	3. suitable for tubes ø 22 mm
0000PA0102C	4. suitable for the profile of Alpha trolleys



CARRY BASKETS

PAPER HOLDERS FOR PAPER ROLLS

QUIVERS

HOLDER FOR GLOVES AND DISINFECTANT SOLUTION

DOOR STOPPERS

HOSES FOR BUCKET FILLING

NOTE BOARDS

TOOL HOLDER AND HOOKS

BAGS

WHEELS

NEW App: each tool in place

App is an **indispensable tool for efficiently organising tools**: available in two sizes and equipped with $\varnothing 20/30$ mm hooks and handle holders, it enables tools to be hung up once the operation is complete, providing considerable advantages.

- **Immediate control**: increases tool sight when stored
- **Optimal drying**: allows complete drying after cleaning
- **Long life**: prevents deformation, extending the life of products

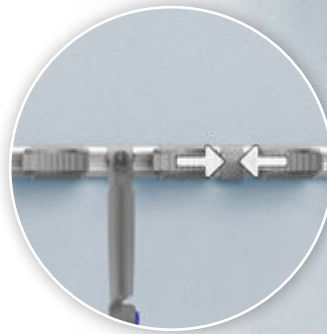

The 30 and 50 cm bars can be combined with each other to **form large storage walls**, while the hook set and the wall-mounted handle holder are ideal for **efficiently organising narrow workplaces**.

■ Tool holder

APP - tool-hanging system with support for $\varnothing 20/30$ mm handles and hooks

NEW



REF.	NOTES	SIZE (cm) ↓ ↓ ↓
0000SM00409	with 2 handle holders and one hook for tools	31,5x8,5x5,5
0000SM00410	with 3 handle holders and 2 hooks for tools	51,5x8,5x5,5

APP - set 2 hooks for tools with wall fixing

NEW



REF.	NOTES	SIZE (cm) ↓ ↓ ↓
P190214U		8,9x8,7x4,6

APP - support for $\varnothing 20/30$ mm handles with wall fixing

NEW



REF.	NOTES	SIZE (cm) ↓ ↓ ↓
P190215U		8,9x9,9x4,6

Aluminium bar for App system

NEW



REF.	NOTES	SIZE (cm) ↓ ↓ ↓
A1230203		30
A1230204		50

Tool holder hook for App system

NEW



REF.	NOTES	SIZE (cm) ↓ ↓ ↓
P190212U		7,5x4x4,6

Support for $\varnothing 20/30$ mm handles for App system

NEW



REF.	NOTES	SIZE (cm) ↓ ↓ ↓
P190213U		8,5x8x4,6

Uni-Move: universal handle hook

Uni-Move is the handle holder by Filmop to **hang quickly and easily any type of handle** to the service trolley.

Thanks to its **special flexible structure**, Uni-Move **can be fixed in few seconds** to any tool, regardless of its shape or size.

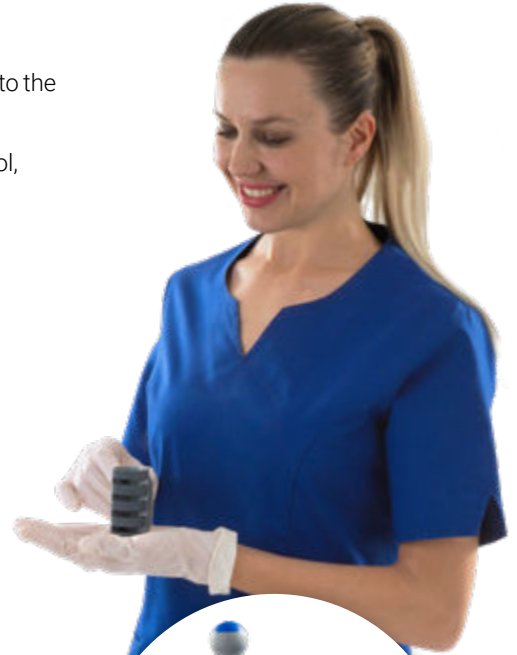

PATENTED SYSTEM



TWO MATERIALS COMBINED TOGETHER AND RESISTANT



Made of plastic and extensible, shock-absorbing and non-slip rubber, all in one mould.

UNIVERSAL



Thanks to its original and innovating design with a flexible rubber part, it is compatible with handles of several diameters (from 21 mm to 29 mm).

FAST



It can be fixed and removed in just a few seconds.



Uni-Move handle holder

UNI-MOVE - universal plastic handle holder



REF.	NOTES
0000SM00250U	

Plastic support for Uni-Move hook with sign holder

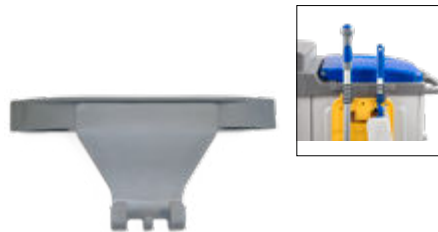

REF.	NOTES
P1919969U	short - applicable to the central frame and central bag holder Alpha trolleys
P1929969U	long - fitting the bag holder 150 L and profile of Alpha trolleys

Holder for Uni-Move handle holder



REF.	NOTES
P1909901U	



CARRY BASKETS

PAPER HOLDERS FOR PAPER ROLLS

QUIVERS

HOLDER FOR GLOVES AND DISINFECTANT SOLUTION

DOOR STOPPERS

HOSES FOR BUCKET FILLING

NOTE BOARDS

TOOL HOLDER AND HOOKS

BAGS

WHEELS

Handle holders

Plastic handle holder

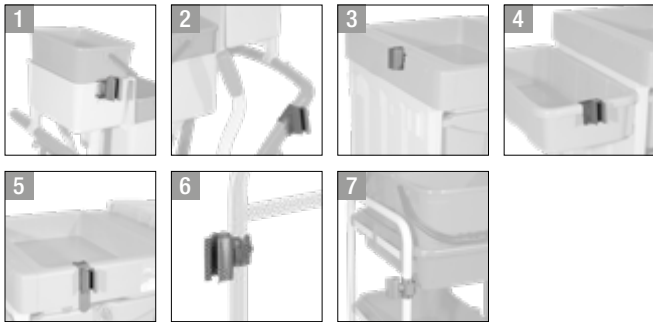

REF.	NOTES
0000SM00100U	1. for basket art. 60402A and bucket holder art. P220001E for Vega-Arka trolleys
0000SM00129U	2. fitting push-bar art. 7964A-7966A for Orion-Vega-Arka trolleys
60072U	3. for Delta bag holder - Alpha bag holder and closing profile
0000SM00122U	4. for Alpha and Morgan side basket
0000SM00206U	5. for Alpha central basket
8214U	6. turning, with screws for tubes \varnothing 22 mm
8223U	6. turning, with screws for tubes \varnothing 14 mm (art. 7151 - 7166)
0000SM00098U	6. turning, with screws for tubes \varnothing 18 mm
0000SM00112U	7. turning, with snap closure for tubes \varnothing 22 mm

Hooks

Plastic hook

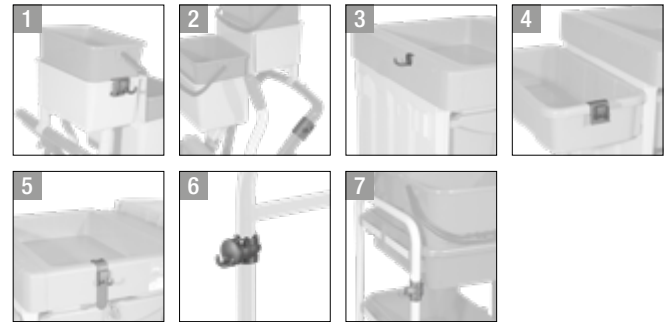
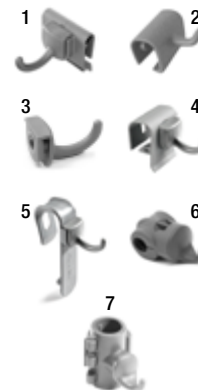

REF.	NOTES
0000SM00215U	1. for basket art. 60402A and bucket holder art. P220001E for Vega-Arka trolleys
0000SM00102U	2. fitting push-bar art. 7964A-7966A for Orion-Vega-Arka trolleys
60082U	3. for Delta bag holder - Alpha bag holder and closing profile
0000SM00205U	4. for Alpha and Morgan side basket
0000SM00212U	5. for Alpha central basket
8235	6. turning, with screws for tubes \varnothing 14 mm (art. 7151 - 7166)
0000SM00113U	7. turning, with snap closure for tubes \varnothing 22 mm

CARRY BASKETS

PAPER HOLDERS FOR PAPER ROLLS

QUIVERS

HOLDER FOR GLOVES AND DISINFECTANT SOLUTION

DOOR STOPPERS

HOSES FOR BUCKET FILLING

NOTE BOARDS

TOOL HOLDER AND HOOKS

BAGS

WHEELS

■ Bis hooks

BIS - double plastic hook

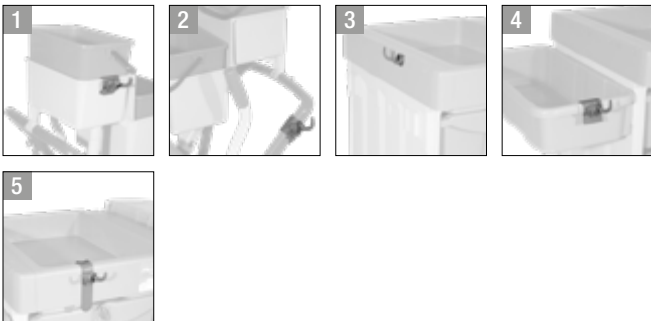
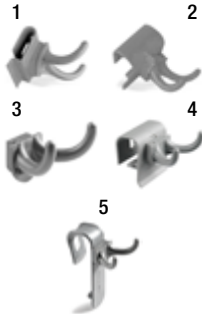

REF.	NOTES
0000SM00140U	1. for basket art. 60402A and bucket holder art. P220001E for Vega-Arka trolleys
0000SM00139U	2. fitting push-bar art. 7964A-7966A for Orion-Vega-Arka trolleys
60080U	3. for Delta bag holder - Alpha bag holder and closing profile
0000SM00141U	4. for Alpha and Morgan side basket
0000SM00208U	5. for Alpha central basket

■ Flip handle holders

FLIP - handle holder with rubber roll

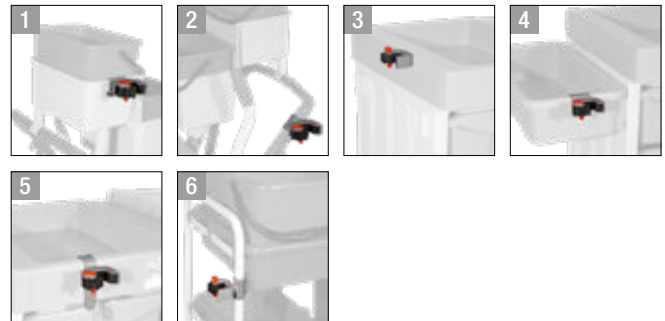

REF.	NOTES
0000SM00110U	1. for basket art. 60402A and bucket holder art. P220001E for Vega-Arka trolleys
0000SM00130U	2. fitting push-bar art. 7964A-7966A for Orion-Vega-Arka trolleys
0000SM00155U	3. for Delta bag holder - Alpha bag holder and closing profile
0000SM00121U	4. for Alpha and Morgan side basket
0000SM00209U	5. for Alpha central basket
0000SM00115U	6. with snap closure for tubes \varnothing 22 mm

■ Holders for spray bottles

Plastic holder for spray bottles

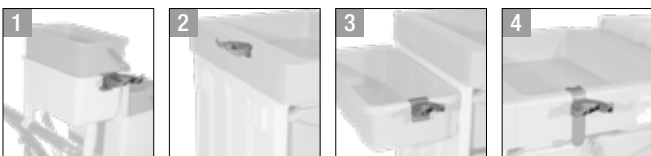
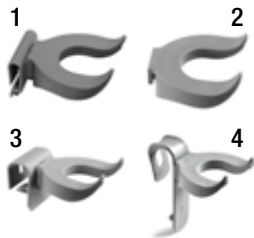

REF.	NOTES
0000SM00145U	1. for basket art. 60402A and bucket holder art. P220001E for Vega-Arka trolleys
P190208U	2. for Delta bag holder, Alpha bag holder and closing profile
0000SM00146U	3. for Alpha and Morgan side basket
0000SM00210U	4. for Alpha central basket

■ Holders for plastic hoses

Plastic holder for hose \varnothing 32 mm

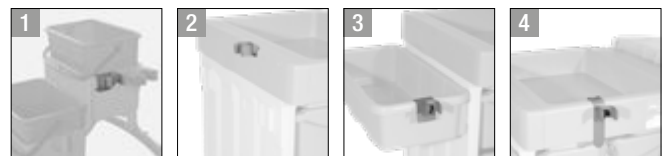

REF.	NOTES
0000SM00310U	1. for basket art. 60402A and bucket holder art. P220001E for Vega-Arka trolleys
P190209U	2. for Delta bag holder, Alpha bag holder and closing profile
0000SM00149U	3. for Alpha and Morgan side basket
0000SM00211U	4. for Alpha central basket



CARRY BASKETS

PAPER HOLDERS FOR PAPER ROLLS

QUIVERS

HOLDER FOR GLOVES AND DISINFECTANT SOLUTION

DOOR STOPPERS

HOSES FOR BUCKET FILLING

NOTE BOARDS

TOOL HOLDER AND HOOKS

BAGS

WHEELS

Plastified bags

Plastified bag with string



REF.	NOTES	CAPACITY (L)	SIZE (cm) ↓ ↓ ↓
0000AT0310A	for Alpha with Split system	45	32x23x63
0000AT0310B	for Alpha with Split system	45	32x23x63
0000AT0170A	for divider 1x40 L + 1x80 L	60	48x97
0000AT0170B	for divider 1x40 L + 1x80 L	60	48x97
0000AT0170E	for divider 1x40 L + 1x80 L	60	48x97
0000AT0160A	for divider 1x40 L + 1x80 L	80	56x92
0000AT0160B	for divider 1x40 L + 1x80 L	80	56x92
0000AT0160E	for divider 1x40 L + 1x80 L	80	56x92
0000AT0300A	for Alpha with Split system	90	50x28x63
0000AT0300B	for Alpha with Split system	90	50x28x63
0000AT0200A	for divider 100 L + 50 L	100	65x93
0000AT0200B	for divider 100 L + 50 L	100	65x93
3650A		120	73x97
3650B		120	73x97
0000AT0190A		150	79x96
0000AT0190B		150	79x96
0000AT0190E		150	79x96

Bags with bottom grip

Plastified bag with bottom grip



REF.	NOTES	CAPACITY (L)	SIZE (cm) ↓ ↓ ↓
0000AT0120E		120	28x42x98

Bags with strap tape system

90l self-standing bag with strap tape system



REF.	NOTES
0000AT0185E	For Morgan Hotel Light trolley bag holder

Bags with eyelets and zipper

Self-supporting plastified bag with eyelets and zipper



REF.	NOTES	CAPACITY (L)	SIZE (cm) ↓ ↓ ↓
0000AT0180U	For bag holder 120 L of Alpha trolleys	120	60x79

CARRY BASKETS

PAPER HOLDERS FOR PAPER ROLLS

QUIVERS

HOLDER FOR GLOVES AND DISINFECTANT SOLUTION

DOOR STOPPERS

HOSES FOR BUCKET FILLING

NOTE BOARDS

TOOL HOLDER AND HOOKS

BAGS

WHEELS

Plastified bags 50 L

Plastified bag



REF.	NOTES	CAPACITY (L)	SIZE (cm) ↓ ↓ ↓
0000AT0110A		50	60x32x64,5
0000AT0110B		50	60x32x64,5
0000AT0110E		50	60x32x64,5

Mesh bags

Mesh bag with closing string



REF.	NOTES	CAPACITY (L)	SIZE (cm) ↓ ↓ ↓
0000AT0210A	polyester	30	30x60
0000AT0210B	polyester	30	30x60
0000AT0210C	polyester	30	30x60
0000AT0210F	polyester	30	30x60
0000AT0211A	polyester	50	30x90
0000AT0211B	polyester	50	30x90
0000AT0212A	stabilized polyester	70	60x90
0000AT0212B	stabilized polyester	70	60x90
0000AT0214B	stabilized polyester	35	65x46

Ideal for supports art. P1909914U, P1909926U and P1909927U

Polyester bags

White polyester bag with coloured stripe



REF.	NOTES	CAPACITY (L)	SIZE (cm) ↓ ↓ ↓
8057A		150	90x94
8057B		150	90x94
8057C		150	90x94
8057F		150	90x94

For housekeeping trolleys

Bags for laundry collection

White polyester bag with strings and button, with open side and coloured stripe, for laundry collection trolleys



REF.	NOTES	CAPACITY (L)	SIZE (cm) ↓ ↓ ↓
8181A	with blue stripe	70	54x101
8181B	with red stripe	70	54x101
8181C	with yellow stripe	70	54x101
8181F	with green stripe	70	54x101

White polyester bag with strings and button, completely closed, for laundry collection trolleys



REF.	NOTES	CAPACITY (L)	SIZE (cm) ↓ ↓ ↓
8182A	with blue stripe	70	59x102
8182B	with red stripe	70	59x102
8182C	with yellow stripe	70	59x102
8182F	with green stripe	70	59x102

Plastified bag for "X" laundry collection trolley



REF.	NOTES	CAPACITY (L)	SIZE (cm) ↓ ↓ ↓
8052	for art. 8043	150	47x34x90
8052/1	for art. 8044	180	51x39x82



CARRY BASKETS

PAPER HOLDERS FOR PAPER ROLLS

QUIVERS

HOLDER FOR GLOVES AND DISINFECTANT SOLUTION

DOOR STOPPERS

HOSES FOR BUCKET FILLING

NOTE BOARDS

TOOL HOLDER AND HOOKS

BAGS

WHEELS

Plastified bag with front opening for foldable X-trolley for laundry collection



REF.	NOTES	CAPACITY (L)
Q0400131E		200
Q0400132E		100

Different wheels

Wheel ø 35 mm



REF.	NOTES
2793	for Prisma, Twin, Top-Down®, Pick-Up, Trend and art. 0000SE1428

Wheel ø 50 mm



REF.	NOTES
7949	For King, Spider, Rocket Wheels, Duo Pro System, Prisma, Twin, Top-Down®, Pick-Up, Trend and code 0000SE1428

Kit wheels and bumpers for laundry collection trolleys art. 3105-3106



REF.	NOTES
0000SM00312	

Wheel ø 80 mm



REF.	NOTES
8063	1. for Jack, Mini Jack, Filmop, Scala, Panda trolleys, laundry trolleys, trolleys for wax application and art. 8042 - 8042/1
8063/7	2. for OneFred, Fred, Orion, Vega, Arka, Jumpy, Oscar, Twice and Maxi Jolly trolleys
8063/6	3. for Baby
8063/4	4. for art. 8045 and 8070

For even indoor floors

Wheel ø 80 mm with brake



REF.	NOTES
8063/3	1. for Jack, Mini Jack, Filmop, Scala, Panda trolleys, laundry trolleys, trolleys for wax application and art. 8042 - 8042/1
8063/9	2. for Baby
8063/10	3. for art. 8045 and 8070

For even indoor floors

Wheel ø 100 mm

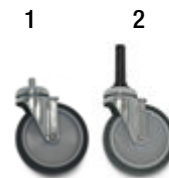

REF.	NOTES
8064	1. for Teddy, Jumbo and Ecology trolleys
8064/3	2. for Morgan trolleys

For even indoor floors

CARRY BASKETS

PAPER HOLDERS FOR PAPER ROLLS

QUIVERS

HOLDER FOR GLOVES AND DISINFECTANT SOLUTION

DOOR STOPPERS

HOSES FOR BUCKET FILLING

NOTE BOARDS

TOOL HOLDER AND HOOKS

BAGS

WHEELS

Wheel ø 100 mm with brake

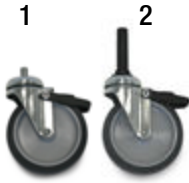

REF. NOTES

8064/1	1. for Teddy, Jumbo and Ecology trolleys
8064/8	2. for Morgan trolleys

For even indoor floors

Wheel ø 100x28 mm



REF. NOTES

23011262	1. for Alpha and Silver trolleys
33011262	2. for Morgan trolleys
94001262	3. for Teddy, Jumbo, Ecology and Panda trolleys

For even indoor and outdoor floors

ø 100x28 mm wheel with brake

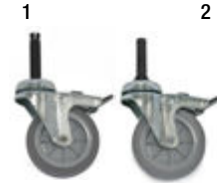

REF. NOTES

23011272	1. for Alpha and Silver trolleys
33011272	2. for Morgan trolleys

For even indoor and outdoor floors

ø 125x28 mm wheel

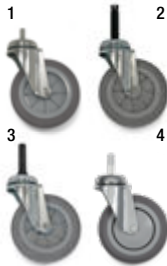

REF. NOTES

2795	1. for Teddy, Jumbo, Ecology and Panda trolleys
23011250	2. for Alpha and Emotion trolleys
33011250	3. for Morgan trolleys
13011310	4. for supporting plate art. P314001U - Morgan Hotel trolleys

For even indoor and outdoor floors

ø 125x28 mm wheel with brake

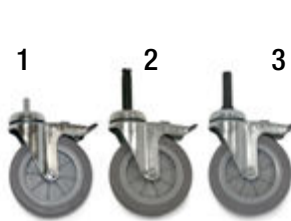

REF. NOTES

2795/1	1. for Teddy, Jumbo, Ecology and Panda trolleys
23011251	2. for Alpha and Emotion trolleys
33011251	3. for Morgan trolleys

For even indoor and outdoor floors

ø 125 mm rubber wheel



REF. NOTES

24011298	1. for Alpha and Silver trolleys
34011274	2. for Morgan trolleys
54011274	3. for supporting plastic plate ref. P314005U - for Morgan Hotel trolleys
64011274Q	4. for supporting plastic plate ref. P075130Q - for Emotion trolleys
94001298	5. for Teddy, Jumbo, Ecology and Panda trolleys

Quiet wheels for indoor floors

ø 125 mm rubber wheel with brake



REF. NOTES

24011299	1. for Alpha and Silver trolleys
34011283	2. for Morgan trolleys

Quiet wheels for indoor floors

Rubber wheel ø 125 mm Metal Free



REF. NOTES

P24011285A	
-------------------	--

Quiet wheels for indoor floors

ø 150 mm rubber wheel



REF. NOTES

24011295	1. for Alpha and Silver trolleys
34011276	2. for Morgan trolleys
64011276Q	3. for plate art. P075130Q for Emotion trolleys

Quiet wheels for indoor floors - Can take heavy loads



CARRY BASKETS

PAPER HOLDERS FOR PAPER ROLLS

QUIVERS

HOLDER FOR GLOVES AND DISINFECTANT SOLUTION

DOOR STOPPERS

HOSES FOR BUCKET FILLING

NOTE BOARDS

TOOL HOLDER AND HOOKS

BAGS

WHEELS

■ ϕ 130 wheels for bumper

ϕ 150 mm rubber wheel with brake

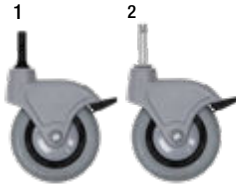

REF.	NOTES
24012296	1. for Alpha and Silver trolleys
34012301	2. for Morgan trolleys

Quiet wheels for indoor floors - Can take heavy loads

125mm ϕ rubber wheel with long pin for bumper item no. P190611U



REF.	NOTES
84011298	for Alpha and Silver trolleys

125mm ϕ rubber wheel with long pin for bumper item no. P190611U lockable



REF.	NOTES
84011299	for Alpha and Silver trolleys

■ Wheels for maxi bumper

ϕ 125 mm rubber wheel with long pin for bumper art. P190610U



REF.	NOTES
44011298	1. for Alpha trolleys
44011298Q	2. for Emotion trolleys

Quiet wheels for indoor floors

ϕ 125 mm rubber wheel with long pin for bumper art. P190610U and brake



REF.	NOTES
44011299	1. for Alpha trolleys
44011299Q	2. for Emotion trolleys

Quiet wheels for indoor floors

ϕ 150 mm rubber wheel with long pin for bumpers ref. P190610U

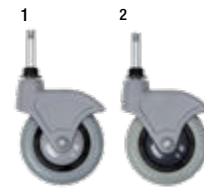

REF.	NOTES
44011295	1. for Alpha trolleys
44011295Q	2. for Emotion trolleys

Quiet wheels for indoor floors - Can take heavy loads

■ Wheels with plate

ϕ 150 mm rubber wheel with long pin for bumpers ref. P190610U and brake



REF.	NOTES
44012301	1. for Alpha trolleys
44012301Q	2. for Emotion trolleys

Quiet wheels for indoor floors - Can take heavy loads

ϕ 100x28 mm wheel with flange



REF.	NOTES
23011282	1. with rotating plate - for Alpha and Emotion (long base), Morgan and Morgan Hotel trolleys
23011284	2. with fixed plate - for Alpha and Emotion (long base), Morgan and Morgan Hotel trolleys
23011278	3. with rotating plate and brake - for Alpha and Emotion (long base), Morgan and Morgan Hotel trolleys

For even indoor and outdoor floors

ϕ 125 mm wheel with plate



REF.	NOTES
23011309	1. with rotating plate - for Alpha and Emotion (long base), Morgan and Morgan Hotel trolleys
23011314	2. with fixed plate - for Alpha and Emotion (long base), Morgan and Morgan Hotel trolleys
23011315	3. with rotating plate and brake - for Alpha and Emotion (long base), Morgan and Morgan Hotel trolleys

CARRY BASKETS

PAPER HOLDERS FOR PAPER ROLLS

QUIVERS

HOLDER FOR GLOVES AND DISINFECTANT SOLUTION

DOOR STOPPERS

HOSES FOR BUCKET FILLING

NOTE BOARDS

TOOL HOLDER AND HOOKS

BAGS

WHEELS

ø 125 mm rubber wheel with plate



REF.	NOTES
24011293	1. with rotating plate - for Alpha and Emotion (long base), Morgan and Morgan Hotel trolleys
24011294	2. with fixed plate - for Alpha and Emotion (long base), Morgan and Morgan Hotel trolleys
24011292	3. with rotating plate and brake - for Alpha and Emotion (long base), Morgan and Morgan Hotel trolleys

Quiet wheels for indoor floors

ø 150 mm rubber wheel with plate



REF.	NOTES
24011264	1. with rotating plate - for Alpha and Emotion (long base), Morgan and Morgan Hotel trolleys
24011266	2. with fixed plate - for Alpha and Emotion (long base), Morgan and Morgan Hotel trolleys

Quiet smooth-gliding wheels for indoor floors, including uneven floors

ø 200x45 mm wheel with plate



REF.	NOTES
23011290	1. with rotating plate - for Alpha and Emotion trolleys (long base)
23011289	2. with fixed plate - for Alpha and Emotion trolleys (long base)

For indoor floors - Can take heavy loads - Can also be used on carpet

Rubber wheel for outdoor use ø 200x50 mm with plate



REF.	NOTES
23011285	1. with rotating plate - for Alpha, Emotion (long base) and Morgan
23011286	2. with fixed plate - for Alpha, Emotion (long base) and Morgan

For outdoor floors - Can take heavy loads - Morgan trolleys need special support bars in order to set up

Rubber wheel for outdoor use ø 260x75 mm with plate

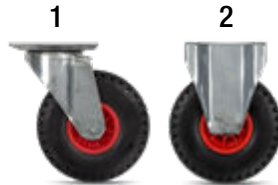

REF.	NOTES
23011291	1. with rotating plate - for Alpha, Emotion and Morgan (long base)
23011308	2. with fixed plate - for Alpha, Emotion and Morgan trolleys (long base)

For outdoor floors - Can take heavy loads - Need special support bars in order to set up

■ Axial wheels

ø 175 mm wheel



REF.	NOTES
2797	1. for Scala and Panda trolleys
2798	2. for trolleys art. 8076-8077

Set of axial wheels ø 200 mm complete with screws

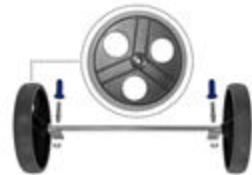

REF.	NOTES
0000SM00128	for plastic mopping trolleys

Galvanised bar to block rubber wheel ø 125 mm from spinning

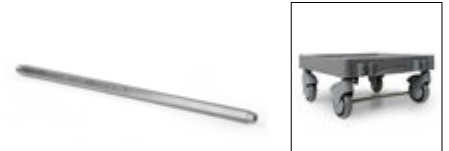

REF.	NOTES
SLZ0960000005	for wheels code 24011298 and 24011299

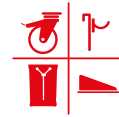

CARRY BASKETS

PAPER HOLDERS FOR PAPER ROLLS

QUIVERS

HOLDER FOR GLOVES AND DISINFECTANT SOLUTION

DOOR STOPPERS

HOSES FOR BUCKET FILLING

NOTE BOARDS

TOOL HOLDER AND HOOKS

BAGS

WHEELS

■ Bumpers

Maxi bumper \varnothing 200 mm with rubber profile



REF.	NOTES
P190610U	for Alpha trolleys with wheels with long pin
P190610Q	for Emotion trolleys with wheels with long pin

\varnothing 130 mm plastic bumper



REF.	NOTES
P190611U	for Silver and Alpha trolleys with wheels with long pin and Morgan Hotel

\varnothing 110 mm plastic bumper with rubber outside



REF.	NOTES
8095	for Jumbo and Ecology trolleys

\varnothing 85 mm plastic bumper



REF.	NOTES
P190600A	for Morgan trolleys
P190600U	for Morgan Hotel trolleys

\varnothing 85 mm plastic bumper



REF.	NOTES
8065A	for mopping trolleys, single buckets, Panda and Teddy trolleys

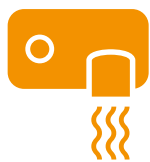

Hygiene line



Dispensers

Air hand dryers

Hairdryers

Bathroom accessories

Hand hygiene floor stands





Aura: bathroom furnishing with style!

Aura is a line of products particularly used in bathrooms.
Impeccable bathroom furnishing, elegant and functional at the same time



- **STYLE:** the products of the Aura range feature stylish materials and different shades, capable of meeting all needs and offering perfect integration in all environments
- **ERGONOMICS:** what sets Aura apart is the ergonomic design, specifically conceived to make each product intuitive and easy to use
- **HYGIENE:** Aura items and accessories have rounded shapes and smooth surfaces, making cleaning and maintenance easier and facilitating the preservation of hygiene standards

Fresh and Deluxe

Fresh e Deluxe line are characterized by a minimal design and the possibility to **customize the products** used in bathrooms by printing one's own logo in the specific inlay.



Detergent/Disinfectant dispensers

TRAIL LINE stainless steel distributor for soap/sanitiser

REF.	NOTES	SIZE (cm) ↓ ↓ ↓
AU3GP020A0	capacity 0.80 L	11x12,7x27,1

JOLLY LINE white plastic (ABS) distributor for soap/sanitiser

REF.	NOTES	SIZE (cm) ↓ ↓ ↓
AU3GP200P0	capacity 0.9 L	9,5x13x23,3

 Foam soap dispenser **SNOW LINE** white plastic (ABS)

REF.	NOTES	SIZE (cm) ↓ ↓ ↓
AU3SP100P0	capacity 0,8 L	10,7x25x33,5

FRESH LINE white plastic (ABS) distributor for soap/sanitiser

REF.	NOTES	SIZE (cm) ↓ ↓ ↓
AU3GP100P0	capacity 1 L	8,9x11,9x23,6

SENSOR - automatic dispenser in white plastic (ABS) for detergent/disinfectant

REF.	NOTES	SIZE (cm) ↓ ↓ ↓
AU3GA100P0	capacity 1 L	12x12,3x26,5

DELUXE LINE black plastic (ABS) distributor for soap/sanitiser

REF.	NOTES	SIZE (cm) ↓ ↓ ↓
AU3GP100P7	capacity 1 L	8,9x11,9x23,6

Hand towel dispensers

DELUXE LINE CONTROL black plastic (ABS) distributor for soap/sanitiser

REF.	NOTES	SIZE (cm) ↓ ↓ ↓
AU3GP200P7	capacity 0.9 L	10x13x23,5

 Hand towel dispenser **TRAIL LINE** stainless steel for "C" or "Z" - shaped paper towels

REF.	NOTES	SIZE (cm) ↓ ↓ ↓
AU1MS010A0	capacity 600 pcs	13,3x26,1x34,2

 Hand towel dispenser **TRAIL LINE** stainless steel for towel roll ø 205 mm

REF.	NOTES	SIZE (cm) ↓ ↓ ↓
AU1MR100A0		25x23x32



DISPENSERS

AIR HAND DRYERS

HAIRDRYERS

BATHROOM ACCESSORIES

HAND HYGIENE FLOOR STANDS

Hand towel dispenser **TRAIL LINE** stainless steel for towel roll ø 130 mm



REF.	NOTES	SIZE (cm) ↓ ↓ ↓
AU1MR300A0		14x15x28

Hand towel dispenser **SNOW LINE** white plastic (ABS) for "C" or "Z" - shaped paper towels and paper roll ø 120 mm



REF.	NOTES	SIZE (cm) ↓ ↓ ↓
AU1MD010P0	Capacity: 400 pcs / 1 roll ø 120 mm and 230 mm long	18x26x26

Hand towel dispenser **FRESH LINE** in white plastic (ABS) for "C" or "Z" - shaped paper towels



REF.	NOTES	SIZE (cm) ↓ ↓ ↓
AU1MS020P0	capacity 600 pcs	13x27,5x36,5

Hand towel dispenser **SNOW LINE** white plastic (ABS) for towel roll ø 130 mm



REF.	NOTES	SIZE (cm) ↓ ↓ ↓
AU1MR300P0		13,9x14,1x28,7

Hand towel dispenser **FRESH LINE** in white plastic (ABS) for towel roll ø 205 mm



REF.	NOTES	SIZE (cm) ↓ ↓ ↓
AU1MR010P0		23x23x33,4

FRESH LINE in white plastic (ABS) dispenser for ø 210 mm paper towel roll with automatic cutter



REF.	NOTES	SIZE (cm) ↓ ↓ ↓
AU1MR900P0		23,5x28,5x36

Hand towel dispenser **DELUXE LINE** in black plastic (ABS) for "C" or "Z" - shaped paper towels



REF.	NOTES	SIZE (cm) ↓ ↓ ↓
AU1MS020P7	capacity 600 pcs	13x27,5x36,5

Hand towel dispenser **DELUXE LINE** in black plastic (ABS) for towel roll ø 205 mm



REF.	NOTES	SIZE (cm) ↓ ↓ ↓
AU1MR010P7		23x23x33,4

DELUXE LINE in black plastic (ABS) dispenser for ø 210 mm paper towel roll with automatic cutter



REF.	NOTES	SIZE (cm) ↓ ↓ ↓
AU1MR900P7		23,5x28,5x36

Toilet paper dispensers

Toilet paper dispenser **TRAIL LINE** stainless steel for toilet paper roll \varnothing 220 mm 300 mt long



REF.	NOTES	SIZE (cm) ↓ ↓ ↓
AU1CR020A0	\varnothing 27 x 12,8 cm	12,8

\varnothing fitting mandrel: 45 mm - 55 mm - 76 mm (76 mm with adaptor art. AU9C0004P0)

Toilet paper dispenser **TRAIL LINE** stainless steel for standard toilet paper roll



REF.	NOTES	SIZE (cm) ↓ ↓ ↓
AU1CR500A0	capacity 2 rolls	14x15x28

TRAIL LINE stainless steel dispenser for interfold toilet paper



REF.	NOTES	SIZE (cm) ↓ ↓ ↓
AU1CS010A0	capacity 400 pcs	14x14,5x28

Toilet paper dispenser **FRESH LINE** in white plastic (ABS) for maxi toilet paper roll



REF.	NOTES
AU1CR010P0	\varnothing 27.5 x 12 cm - for roll \varnothing 220 mm, 300 mt long
AU1CR030P0	\varnothing 33.5 x 12.5 cm - For rolls \varnothing 260 mm, length 400 m

\varnothing fitting mandrel: 45 mm - 55 mm - 76 mm (76 mm with adaptor art. AU9C0004P0)

Toilet paper dispenser **SNOW LINE** white plastic (ABS) for standard toilet paper roll



REF.	NOTES	SIZE (cm) ↓ ↓ ↓
AU1CR500P0	capacity 2 rolls	13,8x14,1x28,7

FRESH LINE white plastic (ABS) dispenser for interfold toilet paper



REF.	NOTES	SIZE (cm) ↓ ↓ ↓
AU1CS020P0	capacity 400 pcs	14,5x12,1x28,6

Toilet paper dispenser **DELUXE LINE** in black plastic (ABS) for maxi toilet paper roll



REF.	NOTES
AU1CR010P7	\varnothing 27.5 x 12 cm - for roll \varnothing 220 mm, 300 mt long
AU1CR030P7	\varnothing 34 x 12.5 cm - for roll \varnothing 260 mm, 400 mt long

\varnothing fitting mandrel: 45 mm - 55 mm - 76 mm (76 mm with adaptor art. AU9C0004P0)

DELUXE LINE black plastic (ABS) dispenser for interfold toilet paper



REF.	NOTES	SIZE (cm) ↓ ↓ ↓
AU1CS020P7	capacity 400 pcs	14,5x12,1x28,6

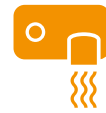

DISPENSERS

AIR HAND DRYERS

HAIRDRYERS

BATHROOM ACCESSORIES

HAND HYGIENE FLOOR STANDS

Automatic air hand dryers

Automatic air hand dryer **TRAIL LINE** stainless steel



REF.	NOTES	SIZE (cm)
AU5MA010A0	power 2000 W, class II	22x28x21

Installation cable not included

Available while stocks last

Automatic air hand dryers **CLASSIC LINE** white laquered



REF.	NOTES	SIZE (cm)
AU5MA010V0	power 2000 W, class II	22x28x21

Installation cable not included

Available while stocks last

Automatic air hand dryer **TRAIL LINE** stainless steel



REF.	NOTES	SIZE (cm)
AU5MA100A0	power 2000 W, class I	14x23x31

Installation cable not included

Available while stocks last

Automatic air hand dryer **SNOW LINE** white plastic (ABS)



REF.	NOTES	SIZE (cm)
AU5MA100P0	power 2000 W, class II	14x23x31

Installation cable not included

Available while stocks last

SNOW LINE automatic high-pressure hand dryer made of white plastic (ABS)



REF.	NOTES	SIZE (cm)
AU5MA200P0	Overall power: 1400 w	17x26,5x33

Installation cable not included

SNOW LINE ERGONOMIC automatic high-pressure hand dryer made of white plastic (ABS)



REF.	NOTES	SIZE (cm)
AU5MA500P0	power 1550 W, class II	18x32x54

Installation cable not included

Air hand dryers with button

Air hand dryers with button **TRAIL LINE** stainless steel



REF.	NOTES	SIZE (cm)
AU5MP010A0	power 2000 W, class II	22x28x21

Installation cable not included

Available while stocks last

Air hand dryers with button **TRAIL LINE** white lacquered



REF.	NOTES	SIZE (cm)
AU5MP010V0	power 2000 W, class II	22x28x21

Installation cable not included

Available while stocks last

Hairdryer with button

Hairdryer **DELUXE LINE** in black plastic (ABS) with bag



REF.	NOTES	SIZE (cm) ↓ ↓ ↓
AU5HP310P7	Overall power: 1800 W	20,5x10x22

Available while stocks last

Hairdryer with button **SNOW LINE** white plastic (ABS)



REF.	NOTES	SIZE (cm) ↓ ↓ ↓
AU5HP300P0	power 1200 W, class II	13x13x14,5

Hairdryer dimensions 17x7x18 cm, support dimensions 13x13x14,5 cm

Accessories

Sanitary towel bag dispenser **SNOW LINE** white plastic (ABS)



REF.	NOTES	SIZE (cm) ↓ ↓ ↓
AU1AW200P0	capacity: 1 recharge with 25 bags	6,5x13x13,5

Available while stocks last

High density polyethylene sanitary towel bags



REF.	NOTES	SIZE (cm) ↓ ↓ ↓
AU9PAC1000	pck: 48 recharges with 25 bags	12,5x9x2

Toilet seat cover dispenser **SNOW LINE** white plastic (ABS)



REF.	NOTES	SIZE (cm) ↓ ↓ ↓
AU1AW210P0	capacity: 125 tissue paper	4x42x31

Toilet brush **TRAIL LINE** stainless steel



REF.	NOTES	SIZE (cm) ↓ ↓ ↓
AU1AW220A0	ø 9 x 39 cm	39

Blank insert for Fresh and Deluxe line



REF.	NOTES
AU9PRS1021	<input checked="" type="checkbox"/>
AU9PRS1020	<input type="checkbox"/>

Adaptor for toilet paper roll with mandrel ø 76 mm



REF.	NOTES
AU9C0004P0	



Floor stands

SLIM - stand for Jolly Line dispenser



REF.	NOTES	SIZE (cm) ↓ ↓ ↓
AU3KP100V7		40x40x133,5

△ ATTENTION: dispenser cod. AU3GP200P0 not included

Touch free floor stands

TANK-PEDAL - painted stand with pedal pump



REF.	NOTES	SIZE (cm) ↓ ↓ ↓
00PV0031	for 5 L tank - sizes tank compartment cm 19,2 x 13,5 x 33 h	37,5x27,5x103
00PV0041	for 10 L tank - sizes tank compartment cm 24 x 20,5 x 38 h	43x34,5x103

△ ATTENTION: Disinfectant tank not included

SLIM SENSOR - stand for Sensor automatic dispenser



REF.	NOTES	SIZE (cm) ↓ ↓ ↓
AU3KA100V7		40x40x136

△ ATTENTION: dispenser cod. AU3GA100P0 not included



Index by item number

General catalogue No. 18 - 2024

Index by item number

REF.	PAGES	REF.	PAGES	REF.	PAGES
000010100YU	49	0000205A	79	00009012FD	55
000010104A	48	0000214AA	80, 136	00009013AD	55
000010104B	48	0000214BB	80, 136	00009013AH	55
000010104C	48	0000214CC	80, 136	00009013BD	55
000010104F	48	0000214FF	80, 136	00009013CD	55
000010104H	48	0000264A	79	00009013DD	55
000010105A	48	0000265A	79	00009013FD	55
000010105B	48	0000311AA	74	00009014AD	55
000010105C	48	0000311BB	74	00009014AH	55
000010105F	48	0000311CC	74	00009014BD	55
000010105H	48	0000311D	73	00009014CD	55
000010105U	48, 230	0000311FF	74	00009014DD	55
000010124A	47	0000312D	73	00009014FD	55
000010124H	47	0000511D	73	0000AM30005	141
000010125A	47	0000512D	73	0000AM30010	141
000010125H	47	00005830	243	0000AM30015	141
000010404A	48	00005835	243	0000AM30015B	141
000010404B	48	00005836	243	0000AM30015C	141
000010404H	48	0000611D	68	0000AM30015F	141
000010405A	48	0000612D	69	0000AM30015U	141
000010405B	48	00008116AB	66	0000AM30020	141
000010405H	48	00008316AB	66	0000AM30025	141
0000121AA	68	00008916AB	66	0000AM3040FZ	140, 227
0000121BB	68	00009011AD	55	0000AM3045A	140
0000121CC	68	00009011AH	55	0000AM3045UA	140
0000121D	68	00009012AD	55	0000AM3045UB	140
0000121FF	68	00009012AH	55	0000AM3045UC	140
0000122D	69	00009012BD	55	0000AM3045UF	140
000020100YU	49	00009012CD	55	0000AM3045UU	140
0000204A	79	00009012DD	55	0000AM3060A	140

REF.	PAGES	REF.	PAGES	REF.	PAGES
0000AM3070A	120, 140, 155	0000AT0211B	59, 306	0000CO2194I	247
0000AM3070UA	120, 140, 155	0000AT0212A	59, 306	0000CO2240D	249
0000AM3070UB	120, 140, 155	0000AT0212B	59, 306	0000CO2240F	249
0000AM3070UC	120, 140, 155	0000AT0214B	59,103, 306	0000CO2910DE	250
0000AM3070UF	120, 140, 155	0000AT0300A	305	0000CO3023D	251
0000AM3070UU	120, 140, 155	0000AT0300B	305	0000CO3030D	239
0000AM3090A	120, 140, 155	0000AT0310A	305	0000CO3031D	239
0000AM3170A	140	0000AT0310B	305	0000CO3032D	239
0000AT0110A	306	0000CO1017D	241	0000CO3033D	239
0000AT0110B	306	0000CO1023D	241	0000CO3034D	239
0000AT0110E	306	0000CO1120D	249	0000CO3036D	239
0000AT0120E	286, 305	0000CO1120F	249	0000CO3060D	239
0000AT0160A	305	0000CO1240D	249	0000CO3061D	239
0000AT0160B	305	0000CO1240F	249	0000CO3062D	239
0000AT0160E	305	0000CO2010DE	250	0000CO3063D	239
0000AT0170A	305	0000CO2012U	209, 243	0000CO3064D	239
0000AT0170B	305	0000CO2017DE	250	0000CO3066D	239
0000AT0170E	305	0000CO2023DE	250	0000CO3090I	246
0000AT0180U	305	0000CO2025D	251	0000CO3091I	246
0000AT0185E	268, 305	0000CO2090I	247	0000CO3092I	246
0000AT0190A	305	0000CO2091I	247	0000CO3093I	246
0000AT0190B	305	0000CO2092I	247	0000CO3094I	246
0000AT0190E	305	0000CO2093I	247	0000CO3130D	239
0000AT0200A	305	0000CO2094I	247	0000CO3131D	239
0000AT0200B	305	0000CO2120D	249	0000CO3132D	239
0000AT0210A	59, 306	0000CO2120F	249	0000CO3133D	239
0000AT0210B	59, 306	0000CO2190I	247	0000CO3134D	239
0000AT0210C	59, 306	0000CO2191I	247	0000CO3136D	239
0000AT0210F	59, 306	0000CO2192I	247	0000CO3160D	239
0000AT0211A	59, 306	0000CO2193I	247	0000CO3161D	239

Index by item number

REF.	PAGES	REF.	PAGES	REF.	PAGES
0000C03162D	239	0000C04224D	252	0000C07450DU	235
0000C03163D	239	0000C05050D	243	0000C08050D	234
0000C03164D	239	0000C05050DUA	243	0000CP1104T	180
0000C03166D	239	0000C05050DUB	243	0000CP1108U	178
0000C03190I	246	0000C05050DUC	243	0000CP1114U	178
0000C03191I	246	0000C05050DUD	243	0000CP1122U	178
0000C03192I	246	0000C05050DUF	243	0000CP1128U	53, 174, 181
0000C03193I	246	0000C05050DUU	243	0000CP1204FZ	231
0000C03194I	246	0000C05050U	243	0000CP1204T	101, 180
0000C03230D	240	0000C05150D	244	0000CP1205T	101, 180
0000C03231D	240	0000C05150U	244	0000CP1206T	101, 180
0000C03232D	240	0000C06170E	245	0000D225000	61
0000C03233D	240	0000C07025D	234	0000D235000	61
0000C03234D	240	0000C07050D	234	0000D253000	61
0000C03236D	240	0000C07050U1	234	0000FD0501D	73
0000C03260D	240	0000C07125DC1	235	0000FD0502D	73
0000C03261D	240	0000C07125DL1	235	0000FD1401D	73
0000C03262D	240	0000C07150DC1	235	0000FD1402D	73
0000C03263D	240	0000C07150DL1	235	0000FD2401D	73
0000C03264D	240	0000C07225DB1	235	0000FD2402D	73
0000C03266D	240	0000C07225DC1	235	0000FS0122D	69
0000C04120D	252	0000C07225DF3	235	0000GI2004A	50
0000C04121D	252	0000C07250DB1	235	0000GI2104A	50
0000C04122D	252	0000C07250DC1	235	0000HA5302U98	273
0000C04123D	252	0000C07250DF3	235	0000HP3100U	265
0000C04124D	252	0000C07325DU	235	0000HP3101U	265
0000C04220D	252	0000C07350DU	235	0000HP3103U	265
0000C04221D	252	0000C07425DG1	235	0000HP3110Q5	286
0000C04222D	252	0000C07425DU	235	0000HP3110U	265
0000C04223D	252	0000C07450DG1	235	0000HP3140U	265

REF.	PAGES	REF.	PAGES	REF.	PAGES
0000HP3300U	263	0000LM30023	141	0000MA6103U00	190
0000HP3301U	263	0000LP0302A	159	0000MA6105U00	187
0000HP3302U	263	0000LP0303A	159	0000MA7103U00	259
0000HP3303U	263	0000LP0304A	159	0000MP1000A	210
0000HP3341U	265	0000LP0305A	159	0000MP1010A	260
0000HP3342U	265	0000LP0307A	159	0000MP1030U	260
0000HP3343U	265	0000LP0308A	159	0000MP1040A	210
0000HP3360U	264	0000LP0309A	159	0000MP1050A	210
0000HP3361U	264	0000LP0321A2	161	0000MP1060A	210
0000HP3362U	264	0000LP1211A2	161	0000MP2010A	211
0000HP3363U	264	0000LP1221A2	161	0000MP2050A	210
0000HP3365U	264	0000LP1401C	150	0000MP2150A	211
0000HP3367U	264	0000LP1402C	150	0000MP3000A	210
0000HP4273U	263	0000LP2310U	122	0000MP3010A	211
0000HP4274U	263	0000MA1100U00	186	0000MP3060A	211
0000HP4304U	264	0000MA1101U00	186	0000MP3080A	211
0000HP4364U	264	0000MA1102U00	259	0000MP4010A	211
0000HP4366U	264	0000MA1104U00	188	0000MP7010A	211
0000HP4368U	265	0000MA1105U00	188	0000MP7020A	212
0000HP4373U	263	0000MA1670U00	193	0000MP8010A	211
0000HP4374U	263	0000MA1673U00	193	0000MP8020A	211
0000LF0030YU	157	0000MA2101U00	186	0000M02230	61
0000LF0031YU	157	0000MA2103U14	186	0000M02530	61
0000LF0033YU	157	0000MA4101U00	187	0000PA0101C	300
0000LF0050YU	157	0000MA4103U00	189	0000PA01020U	49
0000LF0051YU	157	0000MA5101U00	187	0000PA0102C	300
0000LF0053YU	157	0000MA5107U00	189	0000PA0104C	300
0000LF1030YU	157	0000MA5108U18	189	0000PA10300	47
0000LF1050YU	157	0000MA5110U00	190	0000PA10400	46
0000LM30003	141	0000MA5113U01	187	0000PA20300	46

Index by item number

REF.	PAGES	REF.	PAGES	REF.	PAGES
0000PA20400	46	0000SE0108A	179	0000SE1222B	53, 103, 178
0000PN02016	119, 175	0000SE0108B	179	0000SE1222FBZ	230
0000PN02030	93	0000SE0108C	179	0000SE1222U	53, 103, 178
0000PN02040	82, 83	0000SE0115UA	179	0000SE1222UA	178
0000PN02060	45	0000SE0115UB	179	0000SE1222UB	178
0000PN02069	45	0000SE0125UA	179	0000SE1308A	177
0000PN03012EZ	227	0000SE0125UB	179	0000SE1308B	177
0000PN03016	119, 175	0000SE0204FAZ	229	0000SE1308C	177
0000PN03140	75	0000SE0204FBZ	229	0000SE1310A	102, 177
0000PN04012EZ	227	0000SE0204FCZ	229	0000SE1310B	102, 177
0000PN0501	44	0000SE0204FFZ	229	0000SE1314A	177
0000PN0502	44	0000SE0204U	101, 180	0000SE1322A	102, 177
0000SC00200	47	0000SE0204UA	101, 180	0000SE1322B	102, 177
0000SC00211	47	0000SE0204UB	101, 180	0000SE1322FAZ	230
0000SC01030	48	0000SE0204UC	101, 180	0000SE1322FBZ	230
0000SC01040	48	0000SE0204UF	101, 180	0000SE1322U	102, 177
0000SC10200	47	0000SE0628U	174	0000SE1322UA	102, 177
0000SE0104A	179	0000SE0725UB	152	0000SE1322UB	102, 177
0000SE0104B	179	0000SE0815UA	154	0000SE1428A	53, 180
0000SE0104C	179	0000SE0815UB	154	0000SE1428B	53, 180
0000SE0104F	179	0000SE0815UC	154	0000SE1628U	174
0000SE0104FAZ	229	0000SE0815UF	154	0000SE1725UB	152
0000SE0104FBZ	229	0000SE1128B	180	0000SE1815UA	154
0000SE0104FCZ	229	0000SE1208A	177	0000SE1815UB	154
0000SE0104FFZ	229	0000SE1208B	177	0000SE1815UC	154
0000SE0106U	179	0000SE1208C	177	0000SE1815UF	154
0000SE0106UA	179	0000SE1210A	177	0000SE2815UA	154
0000SE0106UB	179	0000SE1210B	177	0000SE2815UB	154
0000SE0106UC	179	0000SE1214A	177	0000SE2815UC	154
0000SE0106UF	179	0000SE1222A	53, 103, 178	0000SE2815UF	154

REF.	PAGES	REF.	PAGES	REF.	PAGES
0000SE3104A	134	0000SM00128	310	0000SM00245D	293
0000SE3104B	134	0000SM00129U	303	0000SM00245E	293
0000SE3104C	134	0000SM00130U	304	0000SM00248U	164
0000SE3104F	134	0000SM00139U	304	0000SM00250U	302
0000SE3104FAZ	230	0000SM00140U	304	0000SM00260	277, 284
0000SE3104FBZ	230	0000SM00141U	304	0000SM00286	101
0000SE3104FCZ	230	0000SM00145U	304	0000SM00287	236
0000SE3104FFZ	230	0000SM00146U	304	0000SM00297	216
0000SE3815UA	154	0000SM00147FZ	227	0000SM00298	208
0000SL2601C	149	0000SM00149U	304	0000SM00299	164
0000SL2700C	148	0000SM00155U	304	0000SM00300	216
0000SL2800C	149	0000SM00163	200, 275, 283	0000SM00301	209
0000SLA30401	173	0000SM00165	200, 275, 283	0000SM00310U	304
0000SLA30402	173	0000SM00165Z	228	0000SM00312	291, 307
0000SM00030C	150	0000SM00205U	303	0000SM00401	208
0000SM00031U	150	0000SM00206U	303	0000SM00402	286
0000SM00032H	150	0000SM00208U	304	0000SM00404	208
0000SM00038U	121, 128	0000SM00209U	304	0000SM00405	208
0000SM00039U	150	0000SM00210U	304	0000SM00406	208
0000SM00098U	303	0000SM00211U	304	0000SM00409	301
0000SM00100U	303	0000SM00212U	303	0000SM00410	301
0000SM00102U	303	0000SM00213U	206, 269, 286	0000SM00600	244
0000SM00110U	304	0000SM00214U	207, 269, 286	0000SM00602	267
0000SM00111	248	0000SM00215U	303	0000SM00603	267
0000SM00112U	303	0000SM00225	293	0000SM00606	205
0000SM00113U	303	0000SM00227D	207, 269, 286	0000SM00607	267
0000SM00115U	304	0000SM00228D	207, 269, 286	0000SM00610	203, 245
0000SM00121U	304	0000SM00242	293	0000SM00612	102
0000SM00122U	303	0000SM00244D	293	0000SM00613	102, 216
0000SM00126	296, 297, 298	0000SM00244E	293	0000SM00617	200, 275

Index by item number

REF.	PAGES	REF.	PAGES	REF.	PAGES
0000SM00619	119	0000TD0010AU	72	0000TP1809AU	85
0000SM00621	119	0000TD0020AU	72	0000TP1812AU	72
0000SM00640	291	0000TD0120A	93	0000TP1813A	43
0000SM00643	297	0000TD0130A	93	0000TP1814A	83
0000SM0131I	248	0000TD0145A	93	0000TP1815A	78
0000SM0132I	248	0000TD0151A	93, 287	0000TP1816A	78
0000SM0133I	248	0000TD0151U	93, 287	0000TP1817U	118
0000SP1200D	292	0000TD0161A	93, 287	0000VA01010	49
0000SP1200E	292	0000TD0320AU	72	00018045A	255
0000SP1300D	292	0000TD0320FZ	227	00018045B	255
0000SP1300D16	292	0000TD0500A	95, 144	00018070	255
0000SP1300E	292	0000TD0600A	95, 144	00018075	255
0000SP1300E16	292	0000TD0920AU	72	0001CO7025D	234
0000SP1301D	293	0000TD1820AU	72	0001CO7050D	234
0000SP1301D16	293	0000TP0004AU	75	0001CO7050U1	234
0000SP1301E	293	0000TP0005AU	75	0001CO7125DC1	235
0000SP1301E16	293	0000TP0009AU	85	0001CO7125DL1	235
0000SP1310D	293	0000TP0011UA	155	0001CO7150DC1	235
0000SP1310E	293	0000TP0011UB	155	0001CO7150DL1	235
0000TA0001A	43, 52	0000TP0011UC	155	0001CO7225DB1	235
0000TA0030A	78	0000TP0011UF	155	0001CO7225DC1	235
0000TA0040A	78	0000TP0012AU	71	0001CO7225DF3	235
0000TA0060A	78	0000TP0303U	89	0001CO7250DB1	235
0000TA0340A	78	0000TP0309AU	85	0001CO7250DC1	235
0000TA0340FZ	227	0000TP0312AU	72	0001CO7250DF3	235
0000TA0360A	78	0000TP0312U	227	0001CO7325DU	235
0000TA0940A	78	0000TP0511U	155	0001CO7350DU	235
0000TA0960A	78	0000TP0909AU	85	0001CO7425DG1	235
0000TA1840A	78	0000TP0912AU	71	0001CO7425DU	235
0000TA1860A	78	0000TP1804AU	75	0001CO7450DG1	235

REF.	PAGES	REF.	PAGES	REF.	PAGES
0001C07450DU	235	0005AS28150A	116	000EPN04012	74
0001C08050D	234	0005LP1250A	161	000EPN06012	74
0002HP4273U	263	0005LP1251A	161	000EPN07011	69
0002SE1222A	122	0005LP1252A	161	000EPN07012	69
0002TD0552A	94	0005LP1253A	161	000EPN07032	69
0002TD0652A	94	0005LP1254A	161	0010SE0628U	174
0002TD1147A	51	0005LP1255A	161	002072001U	230
0003C04220D	253	000E2036	60	0020C07025DA	234
00059878A	116	000E2036B	60	0020C07025DB	234
00059879A	116	000E2037	60	0020C07025DC	234
00059880A	116	000E2037B	60	0020C07025DF	234
00059881A	116	000E2037C	60	0020C07050DA	234
00059882A	116	000E2037F	60	0020C07050DB	234
00059883A	116	000E2045	60	0020C07050DC	234
00059884A	116	000E6013	58	0020C07050DF	234
00059885A	116	000E6014	58	0020P190072DA	235
00059886A	116	000E6015	58	0020P190072DB	235
00059887A	116	000E6016	58	0020P190072DC	235
00059890A	116	000E6109	58	0020P190072DF	235
0005AS01150A	116	000E6110	58	0020P190082DA	235
0005AS02100A	116	000E6112	58	0020P190082DB	235
0005AS02125A	116	000E6113	58	0020P190082DC	235
0005AS02150A	116	000EPN01010	175	0020P190082DF	235
0005AS02200A	116	000EPN02011	81, 136	0020SE0628U	174
0005AS02250A	116	000EPN02012	81, 119, 136	0020SE0725UB	152
0005AS02300A	116	000EPN03011	81, 136	0020SE1725UB	152
0005AS03100A	116	000EPN03012	81, 119, 136	0020SE2742U	203
0005AS03150A	116	000EPN03021	136, 81	0022LP0303A	159
0005AS03200A	116	000EPN03022	81, 119, 136	0022LP1280A	160
0005AS03300A	116	000EPN04011	74	0022LP1281A	160

Index by item number

REF.	PAGES	REF.	PAGES	REF.	PAGES
0022LP1282A	160	00PD04L1L10AA	89	00PN0423A00DB	80, 135
0022LP1283A	160	00PD04S0S00EE	89	00PN0423A00DC	80, 135
0022LP1284A	160	00PN0309A00DA	80, 136	00PN0423A00DF	80, 135
0022LP1285A	160	00PN0309A00DB	80, 136	00PN0506B00	75
0071LF0030YU	157	00PN0309A00DC	80, 136	00PN0506D00	76
0071LF0031YU	157	00PN0309A00DF	80, 136	00PN0513B00	75
0071LF0050YU	157	00PN0311N00	155	00PN0513B00E	75
0071LF0051YU	157	00PN0323A00DA	80, 135	00PN0513D00	76
0071LF1030YU	157	00PN0403H00	52, 81	00PN0513D00E	76
0071LF1050YU	157	00PN0403H00E	52, 81	00PN0603H00	52, 81
0071MA1104U00	188	00PN0406B00	75	00PN0603H00E	52, 81
0071MA4103U00	189	00PN0406C00	70	00PN0606H00	82
0071MA5107U00	189	00PN0406D00	76	00PN0609A00DA	80, 136
0071MA5108U18	190	00PN0406H00	82	00PN0609A00DB	80, 136
0071MA6103U00	190	00PN0406K00	87	00PN0609A00DC	80, 136
0071MA7101U00	191	00PN0409A00DA	80, 136	00PN0609A00DF	80, 136
0071MA8104U00	191	00PN0409A00DB	80, 136	00PN0613H00	82
00FC0402D00	76	00PN0409A00DC	80, 136	00PN0613H00E	82
00FC0402K00	86	00PN0409A00DF	80, 136	00PN0623A00DA	80, 135
00FC0402K01	86	00PN0413B00	75	00PN0803H00	52, 81
00FC0417K00	86	00PN0413B00E	75	00PN0803H00E	52, 81
00FC0417K01	86	00PN0413C00	70	00PN0823A00DA	40, 80
00FM0401D00	76	00PN0413C00E	70	00PN1003H00	52, 81
00FM0401K01	86	00PN0413D00	76	00PN1003H00E	52, 81
00FM0410K01	86	00PN0413D00E	76	00PN1023A00DA	40, 80
00FM0501D00	76	00PN0413H00	82	00PU0101000	44
00PD04L0A01AA	90	00PN0413H00E	82	00PU0102000	125
00PD04L0A01AB	90	00PN0413K00	87	00PU0102001	125
00PD04L0L30AF	89	00PN0413K00E	87	00PU0102002	126
00PD04L0L30BF	89	00PN0423A00DA	80, 135	00PU0203000	134

REF.	PAGES	REF.	PAGES	REF.	PAGES
00PU0415A00	82, 83	03007960A/P	158	0EPD04L0L00FF	89
00PV0031	319	03007965A/P	158	0EPD04L0L50AA	90
00PV0041	319	0300HA2300U05	273	0EPD04L0L50AB	90
00SSSL2601C	151	0300HA3300U05	274	0EPD04L5L50AA	89
00SSSL2700C	150	0300HA5300U06	273	0EPD04L5L50BB	89
00SSSL2800C	150	0300HA5300U98	273	0EPN0404K00	87
00TM0401B00	74	0300HA5304U06	273	0EPN0412K00	87
00TM0401C00	69	0300HR5300U98	273	0EPN0418A00A	81
00TM0401D00	76	0300MA2672U00	193	0EPN0418A00B	81
00TM0414B00	74	0300MA5143U00	259	0EPN0418B00A	74
00TM0414C00	69	0300MA5671U00	193	0EPN0418B00B	74
00TM0414D00	76	0300MA6670U00	194	0EPN0418C00A	70
00TM0501B00	74	04007960A/P	158	0EPN0418C00B	70
00TM0501C00	69	04007965A/P	158	0EPN0418K00A	87
00TM0501D00	76	05002	41	0EPN0418K00B	87
00TM0514B00	74	05002SF	41	0EPN0425A00E	81
00TM0514C00	69	0500HA5301U06	273	0EPN0426A00	81
00TM0514D00	76	0500HA5301U98	273	0ETC0419A00DD	79
0100LF0030YU	157	0500MA2107U00	259	100/5212A	43
0100LF0050YU	157	0C08414	67	100/5213A	43
0120C07025DA	234	0C08414/M	67	10000A	170
0120C07025DB	234	0C08420	67	1000MA8104U00	191
0120C07025DC	234	0C08420/M	67	1000MA8125U00	259
0120C07025DF	234	0C08511	68	10200	242
0120C07050DA	234	0C08511/M	68	10201	242
0120C07050DB	234	0C08512	70	10202	242
0120C07050DC	234	0EPD04L0L00AA	89	10204	242
0120C07050DF	234	0EPD04L0L00AB	89	10300	242
020P2199906EZ	228	0EPD04L0L00BB	89	10305	242
020P2199907EZ	228	0EPD04L0L00CC	89	1053A	141

Index by item number

REF.	PAGES	REF.	PAGES	REF.	PAGES
1054	141	2051A	151	2084A	125
1057	141	2051B	151	2085	125
1059	142	2051C	151	2085A	125
1065	142, 155	2051F	151	2086	125
1069E	141	2060A	148	21002	176
1070	141	2060B	148	21004	178
1084A	125	2061A	151	21005U	174
1085	125	2061B	151	21020U	154
1085A	125	2062A	151	21021A	53, 176
1086	125	2062B	151	21040U	152
1090	127	2070A	148	23011250	308
12000A	170	2070B	148	23011251	308
13011310	308	2070C	148	23011262	308
14000A	170	2070F	148	23011272	308
1430	126	2071A	151	23011278	309
16000A	180	2071B	151	23011282	309
172000A	43	2071C	151	23011284	309
172001A	43	2071F	151	23011285	310
2000CO4120D	253	2072A	151	23011286	310
2000CO4220D	253	2072B	151	23011289	310
2000MA8100U00	187	2072C	151	23011290	310
2012	128	2072F	151	23011291	310
2013	127	2080A	148	23011300	258
2015	142	2080B	148	23011308	310
2039	60	2080C	148	23011309	309
2040	60	2080F	148	23011314	309
2040B	60	2082A	151	23011315	309
2040C	60	2082B	151	24011264	310
2040F	60	2082C	151	24011266	310
2046	60	2082F	151	24011292	310

REF.	PAGES	REF.	PAGES	REF.	PAGES
24011293	310	3082	219	3639B	216, 218, 222
24011294	310	3090	219	3640	217, 220, 223
24011295	308	3100	257	3641A	214, 221
24011298	308	3105	289	3642	214, 221
24011299	308	3106	289	3644A	216, 218, 222
24012296	309	33011250	308	3644B	216, 218, 222
2430U	126	33011251	308	3645A	241
2440U	125	33011262	308	3645B	241
2460U	125, 134	33011272	308	3645C	241
2640U	125	34011274	308	3645E	241
2660U	125, 134	34011276	308	3645F	241
2793	175, 176, 242, 307	34011283	308	3645G	241
2795	308	34012301	309	3645T	241
2795/1	308	3600	221	3647	221
2797	310	3601	220	3648A	241
2798	310	3604	220	3648B	241
3000CO4120D	253	3606	220	3648C	241
3000CO4220D	253	3607	220	3648E	241
3000MA8670U00	195	3610	220	3648F	241
3010	219	3611	220	3648G	241
30141	217	3613	220	3648T	241
30300CL	217	3614	221	3650A	305
30302	217	3615	220	3650B	305
3036	60	3624	220	3655	215
3037	60	3626	221	3657	218
3048	180	3633	220	3659	218
3054	219	3635U	295	3663CL	220
3064	219	3637	220	3665	221
3072	219	3638	218, 220	3667A	221, 241
3080	219	3639A	216, 218, 222	3667B	221, 241

Index by item number

REF.	PAGES	REF.	PAGES	REF.	PAGES
3667C	221, 241	5111/1	39	5182	39
3667E	221, 241	5112	39	5182/1	39
3667F	221, 241	5112/1	39	5184	39
3667G	221, 241	5114	39	5184/1	39
3667T	241	5114/1	39	5187	39
3669U	120, 295	5117	39	5201	40
3671	218	5126/2	39	5201/1	41
3690U	120, 295	5128/2	39	5201/21A	41
3691U	295	5136/2	39	5201/28A	41
4008A	44, 79, 83	5138/2	39	5202	41
4028AB	44, 79, 83	5141	39	5203	41
44011295	309	5141/1	39	5206	44
44011295Q	309	5142	39	5210	44
44011298	309	5142/1	39	5211	40
44011298Q	309	5144	39	5211/PA	40
44011299	309	5144/1	39	5212A	43
44011299Q	309	5147	39	5213A	43
44012301	309	5156/2	39	5214	44
44012301Q	309	5158/2	39	5215	44
50002	44	5161	39	5216	44
50003	44	5161/1	39	5217	44
50004	44	5162	39	5219	44
50011	44	5162/1	39	5220	44
5002SF	41	5164	39	5221	40
5002SL	41	5164/1	39	5221/PA	40
5101	39	5167	39	5222	54
5102	39	5176/2	39	5222F	54
5104	39	5178/2	39	5222G	54
5107	40	5181	39	5222H	54
5111	39	5181/1	39	5223	43

REF.	PAGES	REF.	PAGES	REF.	PAGES
5224	43	5311A	40	60005A	169, 170, 171, 172
5225A	43	5329A	54	6001	58
5228A	54	5341A	40	60057	173
5229A	54	5342H	40	60058	173
5231	40	5359A	77	60059	173
5231/PA	40	5360A	77	60060	173
5233U	119, 135, 175	5361A	40	60062U	44, 79, 120
5234U	119, 135, 175	5362H	40	60068614	145
5239	44	5364A	83	60068624	145
5240	44	5381A	40	60068654	145
5241	40	5388U	118	60072EZ	230
5241/PA	40	5389U	118	60072U	303
5247	44	5390U	175	60080U	304
5248	51	54011274	308	60082EZ	230
5251	40	5503	41	60082U	303
5251/PA	40	5511A	40	60107A	172
5252A	43	5540	40	60108A	172
5253A	51	5544	70	601421	242
5254A	43	5560	40	601422	242
5259A	77	5706	40	601424	242
5260A	77	5716	39	601425	242
5261	40	5746	39	601426	242
5261/PA	40	5766	39	601428	242
5263A	77	5786	39	60152C	150
5264A	83	5803	79	60156A	172
5271	40	5807	79	60193	237
5278A	78	5959A	77	60193A	237
5279A	78	5960A	77	60193B	237
5281	40	6000	58	60193C	237
5281/PA	40	60005/2U	168	60193E	237

Index by item number

REF.	PAGES	REF.	PAGES	REF.	PAGES
60193F	237	60502	169	6300C	60
60193G	237	60503	169	6300D	60
6020A/1-10	59	6050A	58	6300F	60
6020B/1-10	59	6050F	58	6310B	60
6020C/1-10	59	6073	59	6310C	60
6020F/1-10	59	6074	59	6310D	60
6020U/1-10	59	6201D	58	6310F	60
60222	180	6201DA	58	6320A	61
60230	180	6201DB	58	6320B	61
60232	180	6201DC	58	6320C	61
60233U	218	6201DF	58	6320F	61
60234	221	6202D	58	6400B	60
6025U	61	6202DA	58	6400C	60
60294U	176	6202DB	58	6400D	60
60295A	163	6202DC	58	6400F	60
6030	58	6202DF	58	64011274Q	308
60307A	171	6204D	59	64011276Q	308
60308A	171	6205D	59	7002A	171
60311H	171	6206A	59	7003U	168
6035	58	6207A	59	7003UA	168
60356A	171	6207B	59	7003UB	168
6036	58	6207C	59	7003UC	168
60402A	164, 296	6207F	59	7003UF	168
60404U	296	6208A	59	7004A	169
60405U	296	6211D	58	7004E	169
60406Y	163	6211DA	58	701421	240, 248
6042	61	6211DB	58	701422	240, 248
6047	61	6211DC	58	701424	240, 248
60500	169	6211DF	58	701425	240, 248
60501	169	6300B	60	701426	240, 248

REF.	PAGES	REF.	PAGES	REF.	PAGES
701428	240, 248	79000A	42	8004A	173
701431	240, 248	79001A	42	8010	165
701432	240, 248	7914A	53, 176	801400	236
701435	240, 248	7915A	176	8016	165
701436	240, 248	7930CGB	149	8017	165
701439	240, 248	7931CGBSS	150	8018	166
701440	240, 248	7932CGB	150	8020	165
7106	222	7940AGB	148	8024	165
7108	222	7940CGB	148	8032	166
7151	223	7941CGBSS	150	8036	166
7152	222	7949	53, 122, 175, 242	8040	256
7153	223	7960A	158	8042	255
7154	223	7960A/P	158	8042/1	255
7155	222	7961A	158	8043	289
7156	223	7961A/I	158	8044	289
7157CL	223	7961A/P	158	8045A	255
7159	223	7962A	158	8045B	255
7160CL	223	7962A/I	158	8049	257
7161CL	222	7962A/P	158	8050	256
7163	223	7963A	162	8052	306
7166	220, 223	7964A	163	8052/1	306
7200	222	7965A	158	8053	258
72000A	42	7965A/P	158	8054	257, 291
72001A	42	7966A	162	8054/1	257, 291
72002A	42	7970CGB	148	8055B	258
7230	219	7971CGBSS	150	8056DB	258
7235	219	7990CGB	149	8057A	306
73000A	42	8000A	173	8057B	306
7450/2	256	8002/1A	172	8057C	306
78730YSS	162	8002A	172	8057F	306

Index by item number

REF.	PAGES	REF.	PAGES	REF.	PAGES
8058	258	8095	311	8168/1U	238, 287
8063	307	8098X	217	8168U	270
8063/10	307	8107A	179	8169/2	238
8063/3	307	8107B	179	8169/2A	238
8063/4	307	8108A	179	8169/2B	238
8063/6	307	8108B	179	8169/2C	238
8063/7	307	8108C	179	8169/2F	238
8063/9	307	8112	82	8171	260
8064	307	8115U	72	8172	260
8064/1	308	8125AB	66	8174C	256
8064/3	307	8130AU	72	8175	256
8064/8	308	8132AU	72	8181A	306
8065A	311	8134	82, 83	8181B	306
8066	173	8136	94	8181C	306
8068	173	8145G	243	8181F	306
8070	255	8149	94	8182A	306
8071	258	8150	51	8182B	306
8072	258	8151	172	8182C	306
8073B	258	8154	171	8182F	306
8074	257	8162	237	8191F	256
8075	255	8162/1	237	8200X	217
8076	255	8162A	237	8203/2	217
8077	255	8162B	237	8205	258
8077/1	255	8162C	237	8205/1	166
8079	257	8162E	237	8205/2	217, 258
8079/1	257	8162F	237	8211/1A	179
8080X	217	8162G	237	8211/1B	179
8083X	257	8167	260	8213	218, 222, 223
8090X	217	8168/1A	238	8214U	303
8092F	258	8168/1B	238	8215	166

REF.	PAGES	REF.	PAGES	REF.	PAGES
8218A	179	8420/M	67	8623E	172
8218B	179	8422	73	8624	145
8218C	179	8422/M	73	8624.0	145
8218F	179	8423	73	8624D	145
8220/1	257	8423/M	73	8624F	145
8220A	218, 223, 257	8440	256	8624GB	145
8223U	303	8450	256	8633A	171
8225U	218, 222, 223	8511	67	8634	145
8227	218, 223, 257	8511/M	67	8638A	168
8229U	291	8512	70	8638U	168
8234	217	8516	68	8640	169
8235	303	8516A	68	8645	169
8252	218, 220	8516B	68	8654	145
8253	218, 220	8516C	68	8654.0	145
8267	217	8516F	68	8654D	145
8269/1	293	8571	260	8654F	145
8272	260	8593	133	8654GB	145
8331SS	162	8594	133	8730YSS	162
8332SS	162	8599	169, 173	8731Y	162
8335SS	162	8601	173	9007	55
8337SS	162	8608/1	173	9008	55
8338SS	162	8611U	218, 221, 223	9009	55
8400A	258	8613	173	9020	49
8400B	258	8614	145	9021	50
8400C	258	8614.0	145	9022	50
84011298	309	8614D	145	9025	50
84011299	309	8614F	145	9026	50
8414	67	8614GB	145	9028	50
8414/M	67	8615	221	9029	50
8420	67	8617A	172	9034	50

Index by item number

REF.	PAGES	REF.	PAGES	REF.	PAGES
9035	50	9214	121	9405	110
9036	50	9215	121	9406	110
9037	50	9241	109	9407	110
9038	50	9242	109	9421	52
9039	49	9243	109	9423	52
9041	51	9271	114	9430	52
9044	51	9271A	114	9431	52
9045	49	9272	114	9435	110
9047	50	9272A	114	9436	110
9088A	117	9310	146	9437	110
9089/2A	117	9314	121	9441	109
9091	121	9315	121	9442	109
9095	121	9316	121	9443	109
9096A	117	9317	121	9444	109
9105	110	9344	109	9451	112
9106	110	9363	114	9451A	112
9107	110	9363A	114	9452	112
9108	110	9364	114	9452A	112
9111	132	9364A	114	9453	112
9121	49	9365	114	9453A	112
9122	49	9365A	114	9454	112
9130	122	9366	114	9454A	112
9135	110	9366A	114	9505	110
9136	110	9373	114	9506	110
9137	110	9374	114	9507	110
9147	52	9375	114	9535	110
9148	175	9376	114	9536	110
9200/PRO	53	94001262	308	9537	110
9206A	53	94001298	308	9551	112
9211	132	9401	52	9551A	112

REF.	PAGES	REF.	PAGES	REF.	PAGES
9552	112	9753A	113	AU1CS020P7	316
9552A	112	9754	113	AU1MD010P0	315
9553	112	9754A	113	AU1MR010P0	315
9553A	112	9761	113	AU1MR010P7	315
9554	112	9851	54	AU1MR100A0	314
9554A	112	9852	54	AU1MR300A0	315
9561	110	9853	54	AU1MR300P0	315
9562	110	9861	113	AU1MR900P0	315
9563	110	9902	109	AU1MR900P7	315
9564	110	9903	109	AU1MS010A0	314
9590	288	9932	109	AU1MS020P0	315
9591	288	9933	109	AU1MS020P7	315
9592	288	9952	110	AU3GA100P0	314
9593	288	9953	110	AU3GP020A0	314
9602	109	A1110810	170	AU3GP100P0	314
9603	109	A1230203	301	AU3GP100P7	314
9632	109	A1230204	301	AU3GP200P0	314
9633	109	A8644A	169	AU3GP200P7	314
9654	54	AU1AW200P0	318	AU3KA100V7	319
9661	113	AU1AW210P0	318	AU3KP100V7	319
9661A	113	AU1AW220A0	318	AU3SP100P0	314
9702	109	AU1CR010P0	316	AU5HP300P0	318
9703	109	AU1CR010P7	316	AU5HP310P7	318
9732	109	AU1CR020A0	316	AU5MA010A0	317
9733	109	AU1CR030P0	316	AU5MA010V0	317
9751	113	AU1CR030P7	316	AU5MA100A0	317
9751A	113	AU1CR500A0	316	AU5MA100P0	317
9752	113	AU1CR500P0	316	AU5MA200P0	317
9752A	113	AU1CS010A0	316	AU5MA500P0	317
9753	113	AU1CS020P0	316	AU5MP010A0	317

Index by item number

REF.	PAGES	REF.	PAGES	REF.	PAGES
AU5MP010V0	317	I1052075	299	MA0701450U011	191
AU9C0004P0	318	I1052076	299	MA0701500U011	191
AU9PAC1000	318	I1900011	291	MA0706800U000	194
AU9PRS1020	318	I1900050	267	MA0706804U000	194
AU9PRS1021	318	I2190039	174	MA0706806UD00	195
C30075CL	217	I2190044	178	MA0706855UD00	195
C30139CL	217	L0220013	267	MA0801114U000	192
C30140/2	217	L0220014	267	MA0801407U000	192
C30152	166	L0220015	267	MA0806708U000	195
C3605CL	220	L4220013	267	MA0806732UD00	196
C3629CL	220	L4220014	267	MA0806803U000	195
C8201CL	217	L4220015	267	MA0806819U000	196
HA0603002U000	274	L5220013	267	MA0901005U002	260
HA0603003U000	274	MA0001000U000	189	MA0901006U000	259
HA0603004U000	274	MA0001003U000	186	MA0901019U000	259
HA0603005U000	274	MA0001101U000	187	MA2606701U050	194
HA5503006U000	273	MA0003002U003	188	MA3301000U000	187
HA5603003U000	274	MA0101003U000	186	MA3306700U000	194
HR0603003U000	274	MA0101406U000	189	MA3601400U060	190
HR0603006U000	274	MA0201000U000	190	MA3606718U006	194
I1050072	203	MA0301002U000	187	MA3801000U001	187
I1050073	299	MA0306702UD00	194	MA3801400U030	192
I1050074	299	MA0401402U000	189	MA3801500U030	192
I1050075	299	MA0401405U000	189	MA3803003U000	188
I1050076	299	MA0406700U000	193	MA3806701U002	195
I1051074	299	MA0501415U000	190	MA3806710UD00	196
I1051075	299	MA0506702U032	193	MA3806711UD00	196
I1051076	299	MA0506711U006	194	MA3806719U000	196
I1052073	299	MA0603019U000	188	MA3806780U000	195
I1052074	299	MA0701404U000	191	MA3806781UD00	196

REF.	PAGES	REF.	PAGES	REF.	PAGES
MA3806809UD00	196	P059361UX	198	P119003A	213
MA4601400U060	190	P06000	117	P1190041U	102, 178
MA4801400U030	192	P064000A	214, 266	P1190042FZ	231
MA5601416U003	190	P064000U	214, 266	P1190042U	102, 178
MA5801408U003	191	P065060U	198, 266, 275	P1190043A	53
MA5806703U000	195	P066011U	198, 275	P1190044U	180
MA5806709UD00	196	P066031U	198, 275	P1190048UB	174
MR0601400U060	191	P066061U	198, 275	P1190050U	180
MR0806703U000	195	P066231Q	282	P119008U	216
MR3606701U000	194	P066251Q	282	P1191100EZ	229
MR3801400U030	191	P066281Q	282	P1191100U	201, 270, 277, 287
MR3806814UD00	196	P074000A	214	P1199900U	201
MX0236704U000	197	P074000U	214	P120004E	163
MX3336700U009	197	P075060Q	282	P120007A	164, 298
MZ0503700Z900	226	P075060U	198	P120008A	164, 298
MZ0603700Z900	226	P075130Q	282	P1220203E	214
MZ0603706Z901	226	P104001D	293	P1228802Q	284
MZ0803701Z900	226	P104001E	293	P1229900U	204, 276
MZ0803705Z901	226	P104002D	293	P1229906FZ	229
MZ3803702Z900	226	P104002E	293	P1229906U	102, 204, 267, 285
P0190047UA	174	P104003D	293	P1229906UX	204
P0190047UB	174	P104003E	293	P1229907FZ	229
P0190049U	174	P110004A	101	P1229907U	204, 267, 285
P019004U	213	P110014U	101	P1229907UX	204
P025011U	198	P114011A	163	P1229909U	102, 204, 267, 285
P025031U	198	P114021U	291	P130001Q	300
P025061U	198	P119001A	213	P159061Q	282
P059011U	198, 275	P119001U	213	P159061U	198, 275
P059031U	198, 275	P119002A	213	P159081Q	282
P059061U	198, 275	P119002U	213, 270	P159131Q	282

Index by item number

REF.	PAGES	REF.	PAGES	REF.	PAGES
P159141Q	282	P190020U	300	P1901113U	296, 297, 298
P159261Q	282	P190060A	244	P190208U	304
P165000EZ	228	P190060B	244	P190209U	304
P165000Q	282	P190060C	244	P190212U	301
P165000U	198, 266, 275	P190060D	244	P190213U	301
P165001U	198	P190060F	244	P190214U	301
P166031EZ	228	P190060U	244	P190215U	301
P166031U	198, 275	P190061H	244	P190301H	150
P166061Q	282	P190071D	235	P190350E	102, 178
P166081Q	282	P190071U1	235	P190350FZ	231
P166131Q	282	P190072D	235	P190351U	122
P166141Q	282	P190072U1	235	P190360U	103, 205, 230
P166261Q	282	P190073DC1	236	P190371H	151
P175000Q	282	P190073DL1	236	P190600A	311
P175000U	198, 275	P190074DB1	236	P190600U	311
P1780010	170	P190074DC1	236	P190610Q	311
P1780011U	168	P190074DF3	236	P190610U	311
P1780029U	170	P190075DU	236	P190611U	311
P179001A	296, 297, 298	P190076D	236	P190802U	234
P179002A	164, 296, 297, 298	P190077D	234	P1908839E	283
P179032U	117	P190081D	235	P190908U	208, 215, 231, 244
P179040A	121, 128, 140	P190082D	235	P190914A	247
P179047UA	117, 121, 128, 140	P190083DC1	236	P190914B	247
P179049UA	117, 121, 128, 140	P190083DL1	236	P190914C	247
P179078UA	117	P190084DB1	236	P190914F	247
P179079UA	117	P190084DC1	236	P190914I	247
P179080U	293	P190084DF3	236	P190915I	247
P190010E	300	P190085DU	236	P190916A	208
P190015A	122	P1901109U	198	P190920U	213
P190017H	123	P1901112U	206	P190921U	213

REF.	PAGES	REF.	PAGES	REF.	PAGES
P190926D	240	P191069U	120, 79	P2031103U	199
P190927U	291	P191070U	120, 79	P2038805E	282
P190928U	291	P191071U	120, 79	P2038806E	282
P190937D	240	P191077U	120, 79	P2038807E	283
P190972D	254	P191084A	95	P2038808E	283
P190973D	254	P191085U	120, 79	P2039903E	199
P190974D	254	P191104H	79	P2039903FZ	228
P190975N	254	P191105H	79	P2039904E	199
P1909901U	302	P191106H	79	P2039904FZ	228
P1909914U	206	P191107H	79	P2039906E	199
P1909925U	102, 207	P191108H	79	P2039908E	199, 275
P1909926U	206	P191109H	79	P2039909E	199
P1909927U	206	P1918802E	283	P2039910EX	199
P1909932U	181	P1919969U	302	P2039911E	275
P1909933U	103, 207	P192000T	103, 134, 95	P2059963E	200
P1909937EZ	229	P1929969U	302	P206002A	163
P1909937U	205	P1948802E	283	P206003A	163
P1909940U	296	P202001A	212	P206010E	163
P1909948EZ	230	P202002A	212	P206020U	206, 215, 285
P1909948U	208	P202008U	266	P206030U	206, 215, 285
P1909957U	206, 215, 285	P202012U	266	P206040U	206, 215, 285
P1909961U	103, 207	P202017A	212	P210017TA	101
P1909966U	204	P202050A	212	P210017TB	101
P1909967U	202	P202051U	266	P210022TA	101
P1909968U	202	P202053A	212	P210022TB	101
P191000T	103, 134, 95	P202058U	266	P219004U	269
P191021T	95	P202063U	266	P219005U	269
P191045T	95	P202067A	212	P219007U	295
P191061U	44	P202075U	266	P2191101U	295
P191068U	120, 79	P2031102U	199	P2191102U	295

Index by item number

REF.	PAGES	REF.	PAGES	REF.	PAGES
P2191103U	295	P225005U	297	P281001E	163
P2199906U	200, 276	P225006I	248	P290068E	203, 245
P2199907U	200, 276	P230001Q	300	P290074DG1	236
P2199926U	201, 276	P230002A	146	P290074DU	236
P2199926UT	201, 276	P230003C	146	P290084DG1	236
P2199927U	201, 276	P2300D3C	146	P290084DU	236
P2199927UT	201, 276	P2300F3C	146	P290800A	164, 296, 297, 298
P2199936U	201, 276	P230GB3C	146	P2908820Q	284
P2199936UT	201, 276	P2328801Q	284	P2908821Q	284
P2199937U	201, 276	P240001C	146	P2908822Q	284
P2199937UT	201, 276	P240002C	146	P2908823Q	284
P220001E	163	P240003C	146	P290914A	247
P2228800Q	283	P240004B	146	P290914B	247
P2228803Q	284	P2400D1C	146	P290914C	247
P2229906A	204, 267, 285	P2400D2C	146	P290914F	247
P2229906B	204, 267, 285	P2400D3C	146	P290914I	247
P2229906FZ	229	P2400D4B	146	P290929A	291
P2229906U	204, 267, 285	P2400F3C	146	P290929B	291
P2229906UX	204	P2400F4B	146	P290929C	291
P2229907FZ	229	P24011285A	308	P290929F	291
P2229907U	204, 267, 285	P240GB1C	146	P290934A	240
P2229907UX	204	P240GB2C	146	P290934B	240
P2229909U	204, 267, 285	P240GB3C	146	P290934C	240
P2229910Q	284	P240GB4B	146	P290934D	240
P2229911Q	284	P250001C	145	P290934F	240
P2229911U	276	P250002	145	P290934G	240
P2229913U	204	P2780030	170	P290976A	254
P2229914U	204	P2780040	170	P290976B	254
P224002E	163	P2780060	170	P290976C	254
P225004U	164, 297	P278006A	170	P290976D	254

REF.	PAGES	REF.	PAGES	REF.	PAGES
P290976F	254	P291030A	95	P3199903EZ	229
P290977D	253	P291030B	95	P3199903U	201
P290978D	253	P291030C	95	P3199903UA	201
P290979D	253	P291030F	95	P3199903UB	201
P290981D	253	P291050H	83	P3199903UC	201
P290989D	253	P291051H	83	P3199903UF	201
P2909912EZ	229	P291070E	203, 245	P3199903UX	201
P2909912U	206	P291918A	207, 215	P3199905U	201
P2909915U	207	P291918B	207, 215	P3199905UA	201
P2909918FZ	231	P291918FZ	231	P3199905UB	201
P2909918U	207	P291919A	207, 215, 286	P3199905UC	201
P2909920EZ	229	P291919B	207, 215, 286	P3199905UF	201
P2909920U	201	P291919T	207, 215, 286	P3199908U	276
P2909920UX	202	P291920U	207, 215, 269, 277	P3199928U	276
P2909921EZ	229	P291920UA	207, 215, 269, 277	P3199938U	276
P2909921U	202, 276	P291920UB	207, 215, 269, 277	P320100UA	101
P2909921UX	202	P2919943U	208	P320101UA	101
P2909934E	213	P299001C	300	P320200UA	101
P2909946A	207	P3038804E	282	P320201UA	101
P2909946B	207	P3059953E	200, 275	P3228800QU	283
P2909946FZ	231	P3059953EX	200	P3228801QU	284
P2909955A	207	P3059954E	200, 275	P3229915U	206, 284
P2909955B	207	P3059954EX	200	P390300C	151
P2909960U	202	P3059967E	200	P3908833Q	284
P2909962U	207	P3059974E	200, 275	P3908834Q	284
P2909966U	204	P3059977E	275	P3908835Q	284
P291029A	95	P306010A	163	P3908836Q	284
P291029B	95	P306020U	206, 215, 285	P390914A	247
P291029C	95	P314001U	266	P390914B	247
P291029F	95	P314005U	266	P390914C	247

Index by item number

REF.	PAGES	REF.	PAGES	REF.	PAGES
P390914F	247	P514000U	266	P8268801Q	284
P390914I	247	P514005U	266	P8268802Q	284
P390986D	253	P515010U	198	P8268803Q	284
P390987D	253	P515030U	198	P8269907U	202
P3909915U	207	P515060Q	282	P906010U	213
P3909918U	207	P515060U	198	PA50028N	293
P3909952E	200	P515130Q	282	Q0400070G	268
P3909952FZ	228	P516010U	213, 268	Q0400073Q	286
P3909953FZ	228	P606010A	163	Q0400075G	268
P3909954FZ	228	P716010U	213	Q0400101G	268
P3909955A	208	P816010U	213, 268	Q0400102G	268
P3909955B	208	P8161110U	202	Q0400103G	268
P3909962U	207	P8161111U	202	Q0400104	269
P3909966U	204	P8161111UX	202	Q0400105A	95
P391070E	203, 245	P8161112U	202	Q0400106B	95
P3928802E	283	P8161113U	202, 276	Q0400107A	95
P3938802E	283	P8161114EZ	229	Q0400108	95
P3958802E	283	P8161115U	202, 276	Q0400117	269
P3968802E	283	P8168800Q	284	Q0400122P	268
P402050U	212	P8168801Q	284	Q0400131E	291, 307
P402053U	212	P8168802Q	284	Q0400132E	291, 307
P402067U	212	P8168803Q	284	Q0400208	123
P406020U	206, 215, 285	P8169900U	202	Q0400220G	269
P414001U	266	P8169901U	202	Q0400221G	269
P414005U	266	P8169903U	203	Q0400230G	269
P4199903U	201	P8169904U	203	Q0400231G	269
P4199903UA	201	P8169905EZ	229	Q1400010G	267
P4199903UB	201	P8169905U	202	Q1400011E	267
P4199903UC	201	P8169906U	203	Q1400030G	267
P4199903UF	201	P8268800Q	284	Q1400050G	268

REF.	PAGES	REF.	PAGES	REF.	PAGES
Q1400090G	268	R1230112	266	R8377	255
Q1400110G	268	R1230113	266	R9156	290
Q1400118U	269	R1900050	269	R9157	290
Q1400123E	285	R2030106	270	R9158	290
Q1400130G	267	R2030120	104, 214	R9159	290
Q1400210G	268	R2030161	266	R9166	290
R1030010	212	R2050010	216	R9167	290
R1030040	212	R2060010	213	R9168	290
R1030103	212	R2060031	203	R9169	290
R1030113	266	R2060080	270	R9176	290
R1030122	266	R2060081	268	R9177	290
R1030125	212	R2180085	285	R9178	290
R1030134	213	R2180400	241, 250	R9179	290
R1030137	212	R2180406	236	R9256	290
R1030142	266	R2200040	205, 270	R9257	290
R1030144	266	R2200041	214	R9266	290
R1030146	266	R2200045	103, 205	R9267	290
R1030147	212	R2200050	270	R9268	290
R1040010	205, 214	R2200051	270	R9276	290
R1050040	164	R2200120	214	R9277	290
R1050050	164	R2240030	296	R9278	290
R1180050	269	R2240040	296	SAC025	47
R1180080	287	R3030135	270	SE0000020AE01	280
R1200020	214	R3030162	104, 205	SE0104020AE01	280
R1200042	205	R3659	214	SE0105020AE00	280
R1200044	205	R8017	165	SE0105021AE00	279
R1200103	164	R8024	165	SE0106020AE00	280
R1200104	164	R8061/1	162	SE0300020AE00	280
R1230110	266	R8061/2	162	SE0301020AE00	280
R1230111	266	R8218	164	SE0301021AE00	279

Index by item number

REF.	PAGES	REF.	PAGES	REF.	PAGES
SE0304004AE00	279	TCE101029	130	TCH101449	130, 227
SE0304020AE00	281	TCE101030	130	TCH101510	130
SE0305020AE00	281	TCE101039	130	TCH101519	130
SE0305021AE00	279	TCE101040	130	TCH101520	130
SE0306020AE00	281	TCE101049	130	TCH101529	130
SE0306021AE00	279	TCH101010	130	TCH101530	130
SE0316020AE00	281	TCH101019	130	TCH101539	130
SE0317020AE00	281	TCH101020	130	TCH101540	130
SE0318021AE00	280	TCH101029	130	TCH101549	130
SE0401021AE00	279	TCH101030	130	TCH102020	132
SE0404021AE00	279	TCH101039	130	TCH102029	132
SE0505021AE06	279	TCH101040	130	TCH103020	131
SE0506021AE00	280	TCH101049	130	TCH103029	131
SE0605021AE00	279	TCH101120	132	TCH104010	130
SLP015000001D	244	TCH101129	132	TCH104019	130
SLP015000001U	244	TCH101210	131	TCH104020	130
SLP015000004D	244	TCH101219	131	TCH104029	130
SLP015000004U	244	TCH101220	131	TCH104030	130
SLP015000007H	244	TCH101229	131	TCH104039	130
SLP015000009H	244	TCH101230	131	TCH104040	130
SLP036000001A	168	TCH101239	131	TCH104049	130
SLP036000001B	168	TCH101240	131	TCH120020	132
SLP036000001C	168	TCH101249	131	TCH120029	132
SLP036000001F	168	TCH101410	130, 227	TCH201010	130
SLP036000001U	168	TCH101419	130, 227	TCH201019	130
SLP036000003U	168	TCH101420	130, 227	TCH201020	130
SLZ0960000005	310	TCH101429	130, 227	TCH201029	130
TCE101010	130	TCH101430	130, 227	TCH201030	130
TCE101019	130	TCH101439	130, 227	TCH201039	130
TCE101020	130	TCH101440	130, 227	TCH201040	130

REF.	PAGES	REF.	PAGES
TCH201049	130	V190062	244
TCH201120	131	V2030122	104, 209, 215
TCH201129	131	V2060103F	257
TCH401010	131	V2060104F	257
TCH401019	131	V250004H	145
TCH401020	131	V8618	172
TCH401029	131	V8632	171
TCH401030	131	V8643	169
TCH401039	131	Z2060103	257
TCH401040	131	Z2060104	257
TCH401049	131	Z30130	173
TCH404030	131	Z30131	173
TCH404039	131	Z30132	173
TCH601010	131	Z30133	173
TCH601019	131		
TCH601020	131		
TCH601029	131		
TCH601030	131		
TCH601039	131		
TCH601040	131		
TCH601049	131		
TCH602030	132		
TCH602039	132		
TCH603040	132		
TCH603049	132		
TCH803000	132		
TCH803009	132		
U100007	170		
U100017	168		
V1010801	170		

General information

The items manufactured and sold by Filmop® International Srl satisfy all safety requirements and are suitable for use.
Data, weights, descriptions and images of the single articles contained in this catalog are indicative.

Filmop® International Srl, whose policy aims at continuous improvements, reserves the right to make all the necessary changes without notice and at any moment to its products.

The images, photos, drawings and any other representation of Filmop® International Srl products, whether contained or not in catalogues, price lists, brochures and in any advertising material, belong exclusively to Filmop® International Srl and, therefore, cannot be used in any form or in any way by customers or third parties without a specific written authorization by Filmop® International Srl.

The commercialization or advertising of Filmop® International Srl products in any way or by any means by customers or third parties cannot be made anonymously, but must always show Filmop® International Srl logo, unless otherwise authorized by Filmop® International Srl .

Filmop® International Srl trademark on products or in advertising material cannot ever be erased, covered or made invisible.
Any customer's trade mark may be added to Filmop® International Srl logo, but avoiding any confusion concerning the identity of the manufacturer of the goods.



www.filmop.com

Index

● Floor care and dusting	37	● Multipurpose trolleys	182
Dust mopping	38	Alpha	183
Damp mopping	42	Morgan	210
Dustpans	46	Chromed and Rilsan coated trolleys	217
Brooms and brushes	49	● A-B PLUS anti-bacterial system	224
Equipment for wax application	51	A-B PLUS	225
Pad holders	54	● Waste collection	232
Scrapers	54	Bins for separate waste collection	233
Floor squeegees	55	Sanitary bins	250
● Floor cleaning	56	Waste trolleys	252
Mop system	57	Paper holders	260
Tab system	66	● Housekeeping trolleys	261
Pocket system	71	Morgan Hotel Elegance	262
Pocket-tab system	75	Alpha Hotel	271
Strap tape system	77	Emotion	278
Globo system	84	KeepHotel	288
Duo Face system	88	Trolleys for laundry collection	289
Dosing handles	91	Silver	292
● Mop soaking systems	96	● Complements and accessories	294
Mop soaking on demand and pre-soaking system	97	Carry baskets	295
● Glass and surface cleaning line	105	Paper holders for paper rolls	297
Window washers	108	Quivers	298
Window squeegees	111	Holder for gloves and disinfectant solution	299
Telescopic poles	115	Door stoppers	300
Brilliant system	118	Hoses for bucket filling	300
Equipment for glass cleaning	121	Note boards	300
Hand dusters	124	Tool holder and hooks	301
Manual cloths	129	Bags	305
Mono-Roll system	134	Wheels	307
Top-Clean system	135	● Hygiene line	312
● Handles and safety signs	137	Dispensers	314
Handles	138	Air hand dryers	317
Warning safety signs	145	Hairdryers	318
● Buckets and mop trolleys	147	Bathroom accessories	318
Bucket/wringer combos	148	Hand hygiene floor stands	319
Plastic mop trolleys	156		
Chromed and Rilsan coated trolleys	165		
Wringers	167		
Multi-purpose buckets	174		
Top-Down® buckets	177		
Other plastic buckets	179		



FILMOP INTERNATIONAL s.r.l.
(Soc. a Socio Unico)

Via dell'Artigianato, 10/11
35010 VILLA DEL CONTE (PD) - ITALY
Tel. +39 049 9325066 - Fax +39 049 9325317
www.filmop.com - filmop@filmop.com
Reg. Imp. di PD / C.F.: 04848400281
R.E.A.: PD n° 423341

Cod. ISO / VAT / P.IVA: IT 04848400281
Cap. Soc. € 6.000.000 int. vers.



A responsible choice

This PAPER is made of FSC®-certified paper for a responsible forest management.



Product certification valid for a range of plastic products



Product certification valid for a range of textile products



Product certification valid for a selection of wheeled cabinets

Distributor